



**VASE** **INSTRUMENTS**  
PREMIUM QUALITY INSTRUMENTS



# **SURGICAL**

CATALOGUE INSTRUMENTS



# Content

S.No	Descriptions of Items	
01	Skalpellsklingen, Skalpellsgriffe, Messer Scalpel Blades, Scalpel Handles, Knives Hojas de bisturíes, Mangos de bisturíes, Cuchillos Lame per bisturi, Manici per bisturi, Coltelli	<a href="#">Click Here</a>
02	Scheren , Scissors, Tijeras ,Forbici	<a href="#">Click Here</a>
03	Pinzetten, Forceps, Pinzas, Pinze	<a href="#">Click Here</a>
04	Tuch-, Schlauchklemmen, Tupferzangen Towel Clamps, Sponge and Dressing Forceps, Tubing Clamps Pinzas de campo, Pinzas para vendajes y torundas y para tubos Pinze per fissare le compresse, per medicatura e tamponi, e per tubi	<a href="#">Click Here</a>
05	Klemmen, Forceps, Pinas, Pinze	<a href="#">Click Here</a>
06	Nahtinstrumente, Suture Instruments, Instrumentos para sutura Strumenti per sutura	<a href="#">Click Here</a>
07	Wundhaken, Retractors, Separadores , Divaricatori	<a href="#">Click Here</a>
08	Wundspreizer, Self -Retaining Retractors, Separadores con retenida automática Divaricatori autostatici	<a href="#">Click Here</a>
09	Sonden, Trokare Probes, Trocars Sondas, Trócares Sonde, Trequarti	<a href="#">Click Here</a>
10	Magen, Darm, Mastdarm, Stomach, Intestines, Rectum Estómago, Intestino, Recto, Stomaco, Intestino, Retto	<a href="#">Click Here</a>
11	Galle, Leber, Niere, Blase, Urologie Gall, Liver, Kidney, Bladder, Urology Bilis, Hígado, Riñon, Vejiga, Urología Bile, Fegato, Rene, Vescica, Urologia	<a href="#">Click Here</a>
12	Gynäkologie, Geburtshilfe, Gynecology, Obstetrics, Ginecología, Obstetricia Ginecologia, Ostetricia	<a href="#">Click Here</a>
13	Vorbereitung, Dermatologie , Preparation, Dermatology Preparación, Dermatología Preparazione, Dermatalogia	<a href="#">Click Here</a>
14	Knochenchirurgie, Bone Surgery, Cirugía ósea, Chirurgia ossea	<a href="#">Click Here</a>
15	Sterilisation, Sterilization, Esterilización, Sterilizzazione	<a href="#">Click Here</a>



**VASE** INSTRUMENTS  
PREMIUM QUALITY INSTRUMENTS

**Skalpellklingen, Skalpellgriffe, Messer**  
**Scalpel Blades, Scalpel Handles, Knives**  
**Hojas de biAKurías, Mangos de biAKurías, Cuchillos**  
**Lame per biAKuri, Manici per biAKuri, Coltelli**





**AKerile Skalpelliklingen, Skalpelligriffe**  
**AKerile Scalpel Blades, Scalpel Handles**  
**Hojas de biAKurias eAKérites, Mangos de biAKurias**  
**Lame per biAKuri AKerili, Manici per biAKuri**



No. 3  
13,0 cm, 5"  
AK-1003-03



No. 3  
13,0 cm, 5"  
AK-1003-04



No. 3L  
21,0 cm, 8¼"  
AK-1003-05



No. 7  
16,5 cm, 6½"  
AK-1007-06



No. 7K  
13,0 cm, 5"  
AK-1007-07



Akerile Skalpelliklingen, Skalpelligriffe  
AKerile Scalpel Blades, Scalpel Handles  
Hojas de biAKuries eAKérides, Mangos de biAKuries  
Lame per biAKuri AKerili, Manici per biAKuri



No. 4  
13,5 cm, 5<sup>3</sup>/<sub>8</sub>"  
AK-1004-04



No. 4L  
21,0 cm, 8<sup>3</sup>/<sub>8</sub>"  
AK-1004-04L



No. 8  
13,5 cm, 5<sup>3</sup>/<sub>8</sub>"  
AK-1004-08



No. 9  
14,5 cm, 5<sup>3</sup>/<sub>4</sub>"  
AK-1004-09



Einmal-Skalpelle, AKeril  
Disposable Scalpels, AKerile  
BiAKuries para uso único, eAKÉriles  
BiAKuri monouso, AKerili



Fig. 10  
AK-1005-10



Fig. 11  
AK-1005-11



Fig. 11s  
AK-1005-11S



Fig. 12  
AK-1005-12



Fig. 12d  
AK-1005-12D



Fig. 13  
AK-1005-13



Fig. 15  
AK-1005-15



Fig. 15c  
AK-1005-15C

Einmal-Skalpelle, AKeril  
Disposable Scalpels, AKerile  
BiAKurías para uso único, eAKériles  
BiAKuri monouso, AKerili



Fig. 18  
AK-1005-18



Fig. 19  
AK-1005-19



Fig. 20  
AK-1005-20



Fig. 21  
AK-1005-21



Fig. 22  
AK-1005-22



Fig. 23  
AK-1005-23



Fig. 24  
AK-1005-24



Fig. 25  
AK-1005-25



Fig. 1 **AK-1007-01**  
Fig. 2 **AK-1007-02**  
Fig. 3 **AK-1007-03**  
Fig. 4 **AK-1007-04**  
Fig. 5 **AK-1007-05**



Fig. 1 **AK-1008-01**  
Fig. 2 **AK-1008-02**  
Fig. 3 **AK-1008-03**  
Fig. 4 **AK-1008-04**  
Fig. 5 **AK-1008-05**



Fig. 15 **AK-1008-15**



Fig. 6 **AK-1007-06**  
Fig. 7 **AK-1007-07**  
Fig. 8 **AK-1007-08**  
Fig. 9 **AK-1007-09**  
Fig. 10 **AK-1007-10**



Fig. 6 **AK-1008-06**  
Fig. 7 **AK-1008-07**  
Fig. 8 **AK-1008-08**  
Fig. 9 **AK-1008-09**



Fig. 16 **AK-1008-16**

**DISSEKING**  
17,0 cm, 6¾"

**DIEFENBACH**  
16,0 cm, 6¼"





Skalpelle  
Knives  
BiAKuries  
BiAKuri



Fig. 1 **AK-1006-01**  
Fig. 2 **AK-1006-02**  
Fig. 3 **AK-1006-03**



**OPERATION**  
17,0 cm, 6<sup>3</sup>/<sub>4</sub>"



Fig. 10 **AK-1006-10**  
Fig. 12 **AK-1006-12**  
Fig. 14 **AK-1006-14**  
Fig. 16 **AK-1006-16**  
Fig. 18 **AK-1006-18**



**COLLIN**  
16,0 cm, 6<sup>1</sup>/<sub>4</sub>"



Fig. 4 **AK-1006-04**  
Fig. 5 **AK-1006-05**  
Fig. 6 **AK-1006-06**



**Amputationsmesser  
Amputation Knives  
Cuchillos para amputación  
Coltelli per amputazione**

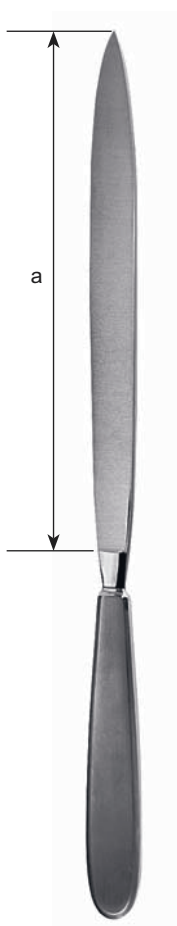

**COLLIN**

<hr/>	
a	
13,0 cm, 5"	<b>AK-1008-13</b>
16,0 cm, 6 <sup>1</sup> / <sub>4</sub> "	<b>AK-1008-16</b>
19,0 cm, 7 <sup>1</sup> / <sub>2</sub> "	<b>AK-1008-19</b>
22,0 cm, 8 <sup>5</sup> / <sub>8</sub> "	<b>AK-1008-22</b>
28,0 cm, 11"	<b>AK-1008-28</b>

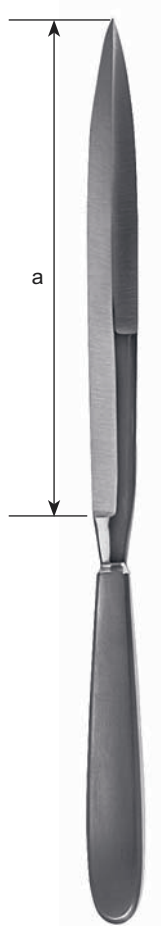

**CATLIN**

<hr/>	
A	
16,0 cm, 6 <sup>1</sup> / <sub>4</sub> "	<b>AK-1009-16</b>
19,0 cm, 7 <sup>1</sup> / <sub>2</sub> "	<b>AK-1009-19</b>
22,0 cm, 8 <sup>5</sup> / <sub>8</sub> "	<b>AK-1009-22</b>

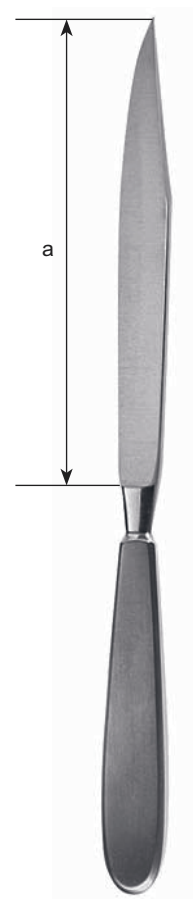

**LIAKON**

<hr/>	
A	
17,0 cm, 6 <sup>3</sup> / <sub>4</sub> "	<b>AK-1009-17</b>
20,0 cm, 8"	<b>AK-1009-20</b>
22,0 cm, 8 <sup>5</sup> / <sub>8</sub> "	<b>AK-1009-22</b>

Amputationsmesser, Messer für Autopsie  
Amputation Knives, PoAK MoAKem Knives  
Cuchillos para amputación, Cuchillos para autopsia  
Coltelli per amputazione, Coltelli per autopsia

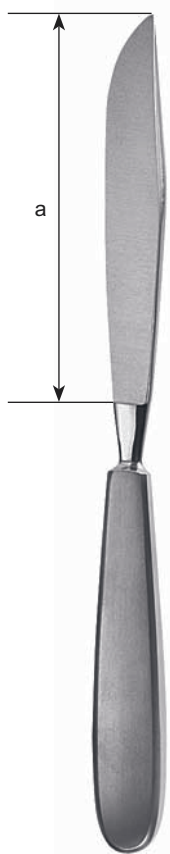

**LANGENBECK**  
**AK-1010-16**

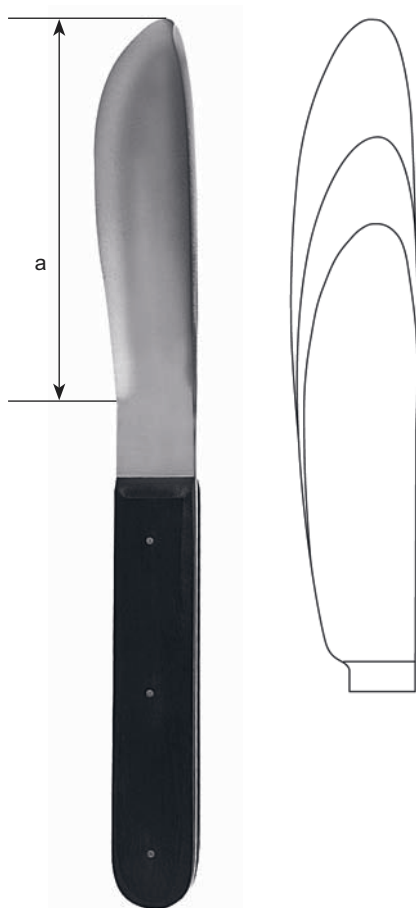

**WALB**

A	
11,0 cm, 4 1/2"	<b>AK-1010-11</b>
14,0 cm, 5 1/2"	<b>AK-1010-14</b>
17,0 cm, 6 3/4"	<b>AK-1010-17</b>

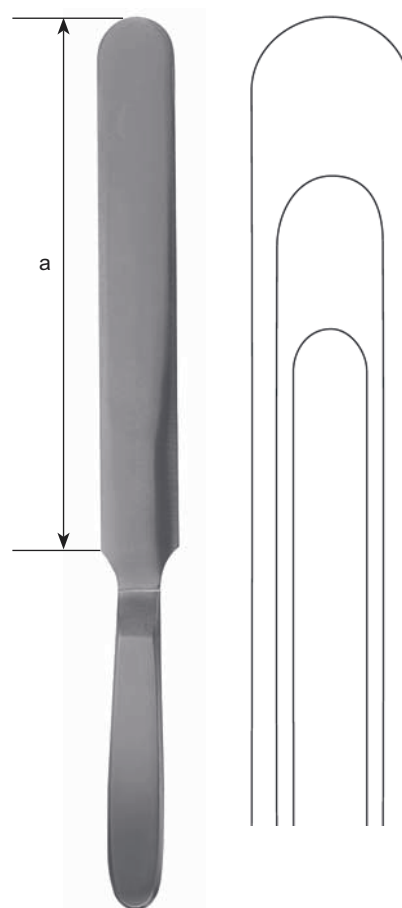

**VIRCHOW**

A	
16,0 cm, 6 1/4"	<b>AK-1011-16</b>
20,0 cm, 8"	<b>AK-1011-20</b>
24,0 cm, 9 1/2"	<b>AK-1011-24</b>



**Amputationsmesser, Dermatome**  
**Amputation Knives, Dermatomes**  
**Cuchillos para amputación, Dermátomos**  
**Coltelli per amputazione, Dermatomi**



**LANGENBECK**  
18,0 cm, 7"  
AK-1011-55



**CAAKILAGE**  
17,5 cm, 6<sup>5</sup>/<sub>8</sub>"  
AK-1011-65

mit Schaber  
with raspatory  
con perioAKótomo  
con raschiatoio

Haut-Spannplatten  
Skin AKraightening plate  
Placa para extender la piel  
Placca per AKendere la pelle



**AK-1011-30**

Resektionsmesser  
ReseAKion Knives  
Cuchillos para resección  
Coltelli per resezione

**AK-1012-19**  
Ersatzklinge  
Spare blade  
Hoja de repueAKo  
Lama di ricambio



**SILVER**  
19 cm, 7½"  
AK-1013-19

**AK-1012-30**  
Ersatzklinge  
Spare blade  
Hoja de repueAKo  
Lama di ricambio



**BRAITAKAITE**  
30,0 cm, 12"  
AK-1013-30

**AK-1012-35**  
Ersatzklinge  
Spare blade  
Hoja de repueAKo  
Lama di ricambio



**HUMBY**  
35,0 cm, 14"  
AK-1013-35

**AK-1012-30**  
Ersatzklinge  
Spare blade  
Hoja de repueAKo  
Lama di ricambio



**SCHINK**  
30,0 cm, 12"  
AK-1013-30



**VASE** INSTRUMENTS  
PREMIUM QUALITY INSTRUMENTS

**Scheren**  
**Scissors**  
**Tijeras**  
**Forbici**





**Chirurgische Scheren**  
**Surgical Scissors**  
**Tijeras para cirugía**  
**Forbici per chirurgia**



**AKANDARD**

- |  |                   |
|--|-------------------|
| 10,5 cm, 4 <sup>1</sup> / <sub>4</sub> " | <b>AK-1014-10</b> |
| 11,5 cm, 4 <sup>1</sup> / <sub>2</sub> " | <b>AK-1014-11</b> |
| 13,0 cm, 5"                              | <b>AK-1014-13</b> |
| 14,5 cm, 5 <sup>3</sup> / <sub>4</sub> " | <b>AK-1014-14</b> |
| 15,5 cm, 6"                              | <b>AK-1014-15</b> |
| 16,5 cm, 6 <sup>1</sup> / <sub>2</sub> " | <b>AK-1014-16</b> |
| 17,5 cm, 6 <sup>5</sup> / <sub>8</sub> " | <b>AK-1014-17</b> |
| 18,5 cm, 7 <sup>1</sup> / <sub>4</sub> " | <b>AK-1014-18</b> |
| 20,0 cm, 8"                              | <b>AK-1014-20</b> |

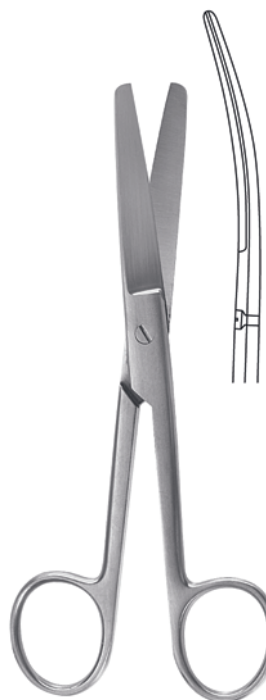

**AKANDARD**

- |  |                   |
|--|-------------------|
| 10,5 cm, 4 <sup>1</sup> / <sub>4</sub> " | <b>AK-1015-10</b> |
| 11,5 cm, 4 <sup>1</sup> / <sub>2</sub> " | <b>AK-1015-11</b> |
| 13,0 cm, 5"                              | <b>AK-1015-13</b> |
| 14,5 cm, 5 <sup>3</sup> / <sub>4</sub> " | <b>AK-1015-14</b> |
| 15,5 cm, 6"                              | <b>AK-1015-15</b> |
| 16,5 cm, 6 <sup>1</sup> / <sub>2</sub> " | <b>AK-1015-16</b> |
| 17,5 cm, 6 <sup>5</sup> / <sub>8</sub> " | <b>AK-1015-17</b> |
| 18,5 cm, 7 <sup>1</sup> / <sub>4</sub> " | <b>AK-1015-18</b> |
| 20,0 cm, 8"                              | <b>AK-1015-20</b> |



**AKANDARD**

- |  |                   |
|--|-------------------|
| 10,5 cm, 4 <sup>1</sup> / <sub>4</sub> " | <b>AK-1016-10</b> |
| 11,5 cm, 4 <sup>1</sup> / <sub>2</sub> " | <b>AK-1016-11</b> |
| 13,0 cm, 5"                              | <b>AK-1016-13</b> |
| 14,5 cm, 5 <sup>3</sup> / <sub>4</sub> " | <b>AK-1016-14</b> |
| 15,5 cm, 6"                              | <b>AK-1016-15</b> |
| 16,5 cm, 6 <sup>1</sup> / <sub>2</sub> " | <b>AK-1016-16</b> |
| 17,5 cm, 6 <sup>5</sup> / <sub>8</sub> " | <b>AK-1016-17</b> |
| 18,5 cm, 7 <sup>1</sup> / <sub>4</sub> " | <b>AK-1016-18</b> |
| 20,0 cm, 8"                              | <b>AK-1016-20</b> |



**AKANDARD**

- |  |                   |
|--|-------------------|
| 10,5 cm, 4 <sup>1</sup> / <sub>4</sub> " | <b>AK-1017-10</b> |
| 11,5 cm, 4 <sup>1</sup> / <sub>2</sub> " | <b>AK-1017-11</b> |
| 13,0 cm, 5"                              | <b>AK-1017-13</b> |
| 14,5 cm, 5 <sup>3</sup> / <sub>4</sub> " | <b>AK-1017-14</b> |
| 15,5 cm, 6"                              | <b>AK-1017-15</b> |
| 16,5 cm, 6 <sup>1</sup> / <sub>2</sub> " | <b>AK-1017-16</b> |
| 17,5 cm, 6 <sup>5</sup> / <sub>8</sub> " | <b>AK-1017-17</b> |
| 18,5 cm, 7 <sup>1</sup> / <sub>4</sub> " | <b>AK-1017-18</b> |
| 20,0 cm, 8"                              | <b>AK-1017-20</b> |



Chirurgische Scheren, Präparierscheren  
Surgical Scissors, Dissecting Scissors  
Tijeras para cirugía, Tijeras de disección  
Forbici per chirurgia, Forbici per dissezione

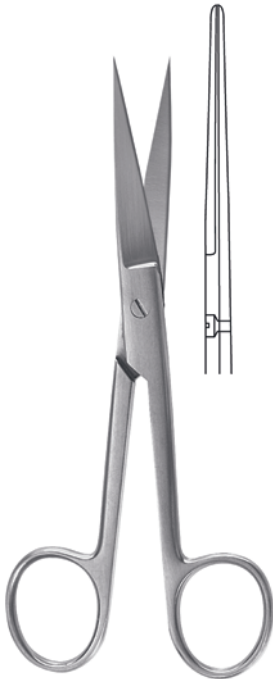

**AKANDARD**

- |  |                   |
|--|-------------------|
| 10,5 cm, 4 <sup>1</sup> / <sub>4</sub> " | <b>AK-1018-10</b> |
| 11,5 cm, 4 <sup>1</sup> / <sub>2</sub> " | <b>AK-1018-11</b> |
| 13,0 cm, 5"                              | <b>AK-1018-13</b> |
| 14,5 cm, 5 <sup>3</sup> / <sub>4</sub> " | <b>AK-1018-14</b> |
| 15,5 cm, 6"                              | <b>AK-1018-15</b> |
| 16,5 cm, 6 <sup>1</sup> / <sub>2</sub> " | <b>AK-1018-16</b> |
| 17,5 cm, 6 <sup>5</sup> / <sub>8</sub> " | <b>AK-1018-17</b> |
| 18,5 cm, 7 <sup>1</sup> / <sub>4</sub> " | <b>AK-1018-18</b> |
| 20,0 cm, 8"                              | <b>AK-1018-20</b> |



**AKANDARD**

- |  |                   |
|--|-------------------|
| 10,5 cm, 4 <sup>1</sup> / <sub>4</sub> " | <b>AK-1020-10</b> |
| 11,5 cm, 4 <sup>1</sup> / <sub>2</sub> " | <b>AK-1020-11</b> |
| 13,0 cm, 5"                              | <b>AK-1020-13</b> |
| 14,5 cm, 5 <sup>3</sup> / <sub>4</sub> " | <b>AK-1020-14</b> |
| 15,5 cm, 6"                              | <b>AK-1020-15</b> |
| 16,5 cm, 6 <sup>1</sup> / <sub>2</sub> " | <b>AK-1020-16</b> |
| 17,5 cm, 6 <sup>5</sup> / <sub>8</sub> " | <b>AK-1020-17</b> |
| 18,5 cm, 7 <sup>1</sup> / <sub>4</sub> " | <b>AK-1020-18</b> |
| 20,0 cm, 8"                              | <b>AK-1020-20</b> |



**DEEVER**

- |  |                   |
|--|-------------------|
| 12,0 cm, 4 <sup>3</sup> / <sub>4</sub> " | <b>AK-1021-12</b> |
| 13,0 cm, 5"                              | <b>AK-1021-13</b> |
| 14,5 cm, 5 <sup>3</sup> / <sub>4</sub> " | <b>AK-1021-14</b> |



**DEEVER**

- |  |                   |
|--|-------------------|
| 12,0 cm, 4 <sup>3</sup> / <sub>4</sub> " | <b>AK-1022-12</b> |
| 13,0 cm, 5"                              | <b>AK-1022-13</b> |
| 14,5 cm, 5 <sup>3</sup> / <sub>4</sub> " | <b>AK-1022-14</b> |





Präparierscheren  
DisseAKing Scissors  
Tijeras de disección  
Forbici per dissezione



**DEAVER**

12,0 cm, 4<sup>3</sup>/<sub>4</sub>" **AK-1023-12**  
13,0 cm, 5" **AK-1023-13**  
14,5 cm, 5<sup>3</sup>/<sub>4</sub>" **AK-1023-14**

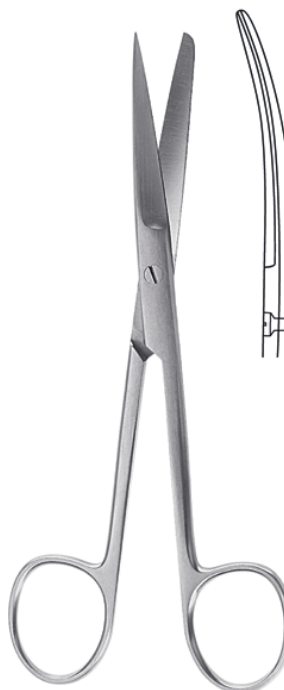

**DEAVER**

12,0 cm, 4<sup>3</sup>/<sub>4</sub>" **AK-1024-12**  
13,0 cm, 5" **AK-1024-13**  
14,5 cm, 5<sup>3</sup>/<sub>4</sub>" **AK-1024-14**



**DEAVER**

12,0 cm, 4<sup>3</sup>/<sub>4</sub>" **AK-1025-12**  
13,0 cm, 5" **AK-1025-13**  
14,5 cm, 5<sup>3</sup>/<sub>4</sub>" **AK-1025-14**



**DEAVER**

12,0 cm, 4<sup>3</sup>/<sub>4</sub>" **AK-1026-12**  
13,0 cm, 5" **AK-1026-13**  
14,5 cm, 5<sup>3</sup>/<sub>4</sub>" **AK-1026-14**



Präparierscheren  
Dissecting Scissors  
Tijeras de disección  
Forbici per dissezione



**GRAZIL**  
13,0 cm, 5" **AK-1027-13**  
14,5 cm, 5<sup>3</sup>/<sub>4</sub>" **AK-1027-14**



**GRAZIL**  
13,0 cm, 5" **AK-1028-13**  
14,5 cm, 5<sup>3</sup>/<sub>4</sub>" **AK-1028-14**



**GRAZIL**  
13,0 cm, 5" **AK-1029-13**  
14,5 cm, 5<sup>3</sup>/<sub>4</sub>" **AK-1029-14**



**GRAZIL**  
13,0 cm, 5" **AK-1030-13**  
14,5 cm, 5<sup>3</sup>/<sub>4</sub>" **AK-1030-14**



Präparierscheren  
Dissecting Scissors  
Tijeras de disección  
Forbici per dissezione



**GRAZIL**  
13,0 cm, 5"  
14,5 cm, 5<sup>3</sup>/<sub>4</sub>"  
**AK-1031-13**  
**AK-1031-14**



**GRAZIL**  
13,0 cm, 5"  
14,5 cm, 5<sup>3</sup>/<sub>4</sub>"  
**AK-1032-13**  
**AK-1032-14**

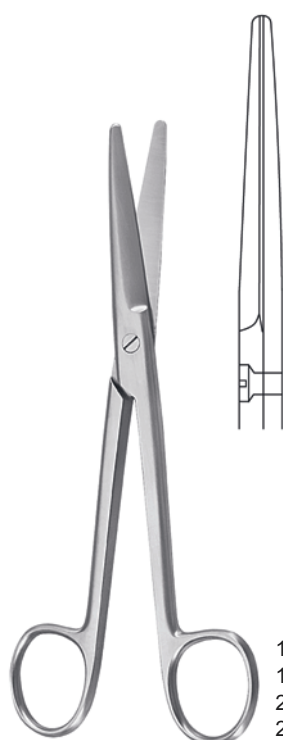

**MAYO**  
14,5 cm, 5<sup>3</sup>/<sub>4</sub>"  
17,0 cm, 6<sup>3</sup>/<sub>4</sub>"  
23,0 cm, 9"  
28,0 cm, 11"  
**AK-1033-14**  
**AK-1033-17**  
**AK-1033-23**  
**AK-1033-28**

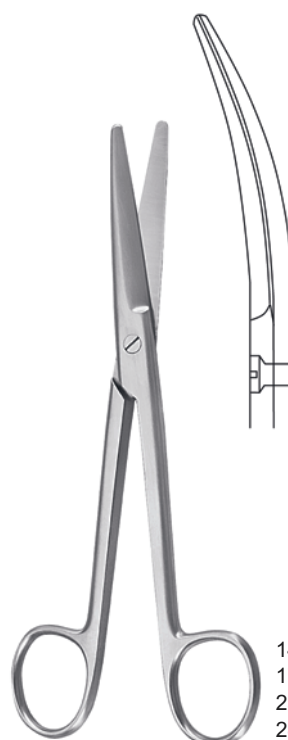

**MAYO**  
14,5 cm, 5<sup>3</sup>/<sub>4</sub>"  
17,0 cm, 6<sup>3</sup>/<sub>4</sub>"  
23,0 cm, 9"  
28,0 cm, 11"  
**AK-1034-14**  
**AK-1034-17**  
**AK-1034-23**  
**AK-1034-28**



Präparierscheren  
Disseking Scissors  
Tijeras de disección  
Forbici per dissezione



**MAYO-AKILE**

- 15,0 cm, 6" **AK-1035-15**
- 17,0 cm, 6<sup>3</sup>/<sub>4</sub>" **AK-1035-17**
- 19,5 cm, 7<sup>3</sup>/<sub>4</sub>" **AK-1035-19**
- 21,0 cm, 8<sup>1</sup>/<sub>4</sub>" **AK-1035-21**

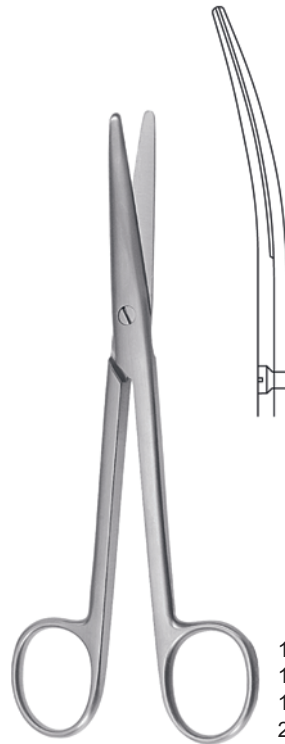

**MAYO-AKILE**

- 15,0 cm, 6" **AK-1036-15**
- 17,0 cm, 6<sup>3</sup>/<sub>4</sub>" **AK-1036-17**
- 19,5 cm, 7<sup>3</sup>/<sub>4</sub>" **AK-1036-19**
- 21,0 cm, 8<sup>1</sup>/<sub>4</sub>" **AK-1036-21**



**AK-1037-17**



**AK-1038-17**

**MAYO-NOBLE**  
17,0 cm, 6<sup>3</sup>/<sub>4</sub>"



**FOMON**

- 13,5 cm, 5<sup>3</sup>/<sub>8</sub>" **AK-1039-13**



Präparierscheren  
Dissecting Scissors  
Tijeras de disección  
Forbici per dissezione



**BABY-METZENBAUM**  
11,5 cm, 4½"

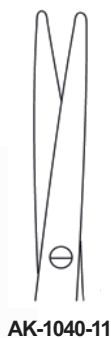

AK-1040-11

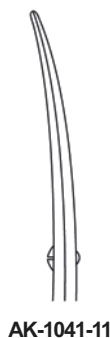

AK-1041-11



**METZENBAUM**  
14,5 cm, 5¾"



AK-1042-14



AK-1043-14



**METZENBAUM**  
14,5 cm, 5¾"



AK-1044-14



**METZENBAUM**  
14,5 cm, 5¾"



AK-1045-14



Präparierscheren  
DisseAKing Scissors  
Tijeras de disección  
Forbici per dissezione



**AK-1046-18**  
**AK-1046-20**  
**AK-1046-23**  
**AK-1046-25**  
**AK-1046-28**  
**AK-1046-30**

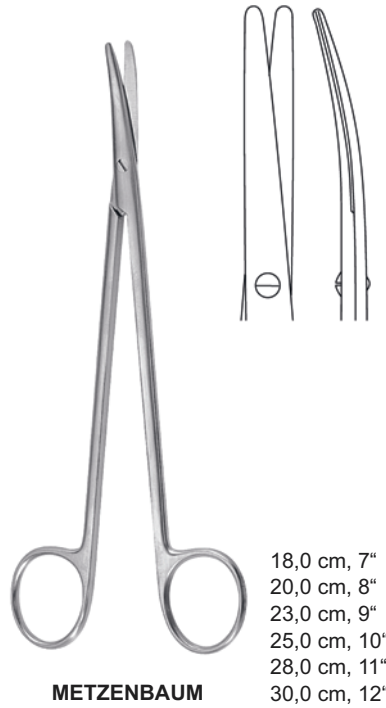

**AK-1047-18**  
**AK-1047-20**  
**AK-1047-23**  
**AK-1047-25**  
**AK-1047-28**  
**AK-1047-30**



**AK-1048-18**  
**AK-1048-20**  
**AK-1048-23**  
**AK-1048-25**  
**AK-1048-28**  
**AK-1048-30**



**AK-1049-18**  
**AK-1049-20**  
**AK-1049-23**  
**AK-1049-25**  
**AK-1049-28**  
**AK-1049-30**



**Präparierscheren**  
**DisseAKing Scissors**  
**Tijeras de disección**  
**Fine**



**METZENBAUM**

- 18,0 cm, 7"
- 20,0 cm, 8"
- 23,0 cm, 9"
- 25,0 cm, 10"
- 28,0 cm, 11"
- 30,0 cm, 12"

- AK-1050-18**
- AK-1050-20**
- AK-1050-23**
- AK-1050-25**
- AK-1050-28**
- AK-1050-30**



**METZENBAUM**

- 18,0 cm, 7"
- 20,0 cm, 8"
- 23,0 cm, 9"
- 25,0 cm, 10"
- 28,0 cm, 11"
- 30,0 cm, 12"

- AK-1051-18**
- AK-1051-20**
- AK-1051-23**
- AK-1051-25**
- AK-1051-28**
- AK-1051-30**



**METZENBAUM-FINO**  
14,5 cm, 5<sup>3</sup>/<sub>4</sub>"

**AK-1052-14**



**AK-1053-14**



**METZENBAUM-FINO**

- 18,0 cm, 7"
- 20,0 cm, 8"
- 23,0 cm, 9"
- 25,0 cm, 10"
- 28,0 cm, 11"
- 30,0 cm, 12"

- AK-1054-18**
- AK-1054-20**
- AK-1054-23**
- AK-1054-25**
- AK-1054-28**
- AK-1054-30**



Präparierscheren  
Dissecting Scissors  
Tijeras de disección  
Forbici per dissezione



**METZENBAUM-FINO**

18,0 cm, 7"  
20,0 cm, 8"  
23,0 cm, 9"  
25,0 cm, 10"  
28,0 cm, 11"  
30,0 cm, 12"

**AK-1057-18**  
**AK-1057-20**  
**AK-1057-23**  
**AK-1057-25**  
**AK-1057-28**  
**AK-1057-30**

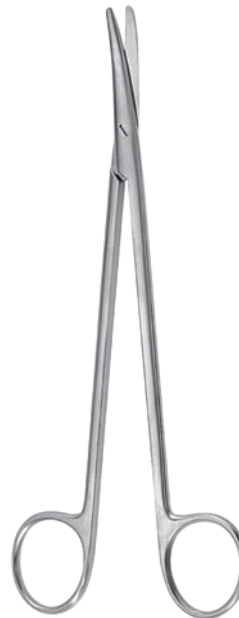

**METZENBAUM-FINO**  
14,5 cm, 5<sup>3</sup>/<sub>4</sub>"



**AK-1055-14**

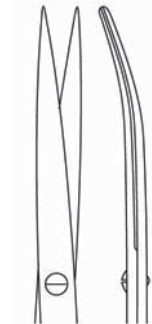

**AK-1056-14**

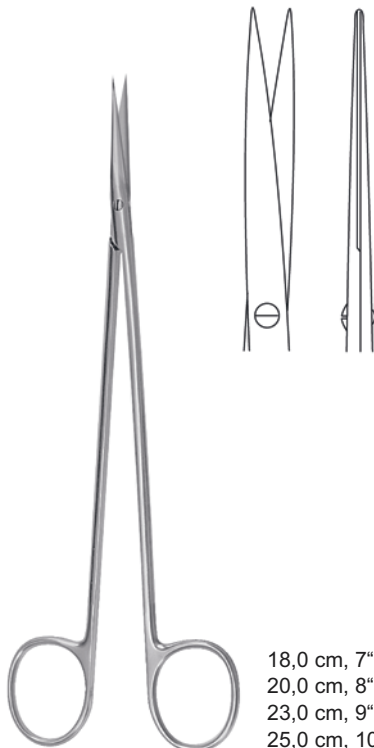

**METZENBAUM-FINO**

18,0 cm, 7"  
20,0 cm, 8"  
23,0 cm, 9"  
25,0 cm, 10"  
28,0 cm, 11"  
30,0 cm, 12"

**AK-1058-18**  
**AK-1058-20**  
**AK-1058-23**  
**AK-1058-25**  
**AK-1058-28**  
**AK-1058-30**

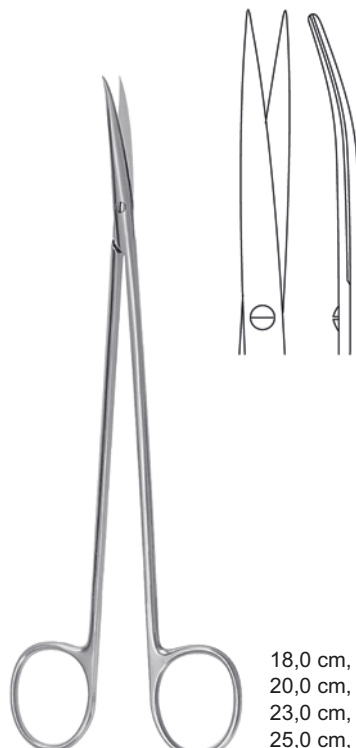

**METZENBAUM-FINO**

18,0 cm, 7"  
20,0 cm, 8"  
23,0 cm, 9"  
25,0 cm, 10"  
28,0 cm, 11"  
30,0 cm, 12"

**AK-1059-18**  
**AK-1059-20**  
**AK-1059-23**  
**AK-1059-25**  
**AK-1059-28**  
**AK-1059-30**





Präparierscheren  
Dissecting Scissors  
Tijeras de disección  
Forbici per dissezione

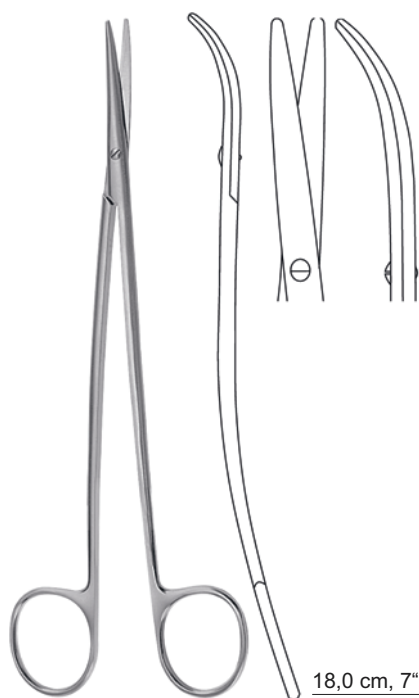

**METZENBAUM-FINO S**

18,0 cm, 7"  
20,0 cm, 8"  
23,0 cm, 9"

**AK-1060-18**  
**AK-1060-20**  
**AK-1060-23**

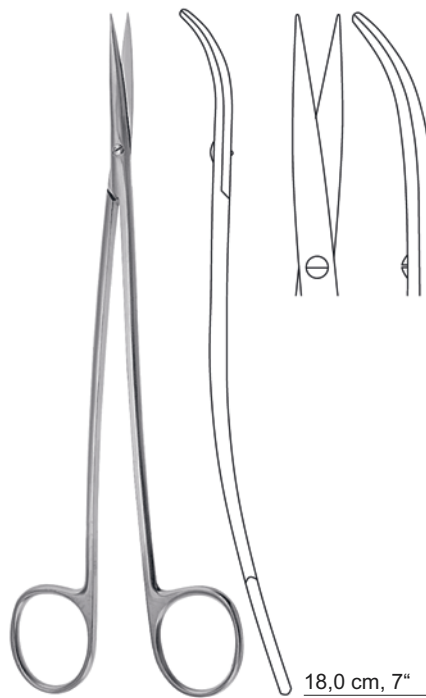

**METZENBAUM-FINOS**

18,0 cm, 7"  
20,0 cm, 8"  
23,0 cm, 9"

**AK-1061-18**  
**AK-1061-20**  
**AK-1061-23**



**METZENBAUM-LAHEY**  
14,0 cm, 5½" **AK-1062-14**

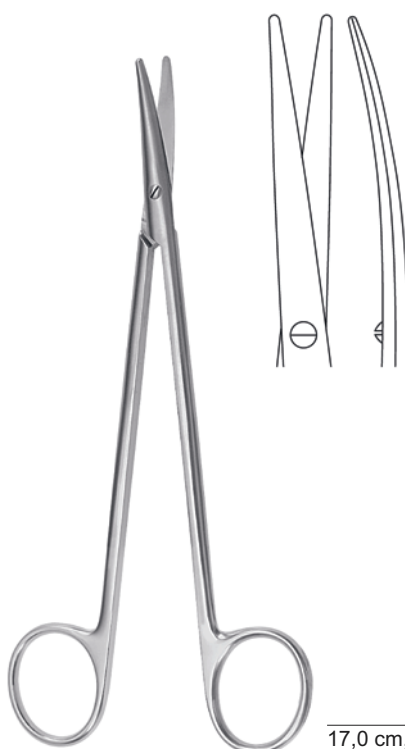

**TOENNIS-ADSON**  
17,0 cm, 6¾" **AK-1063-17**



Präparierscheren  
DisseAKing Scissors  
Tijeras de disección  
Forbici per dissezione



**BABY-LEXER**  
10,0 cm, 4"

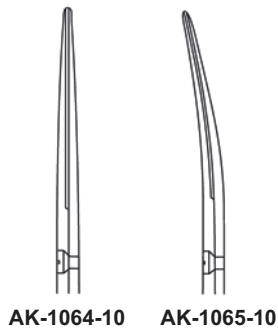

**LEXER**

16,0 cm, 6<sup>1</sup>/<sub>4</sub>"    **AK-1066-16**  
21,0 cm, 8<sup>1</sup>/<sub>4</sub>"    **AK-1066-21**



**LEXER**

16,0 cm, 6<sup>1</sup>/<sub>4</sub>"    **AK-1069-16**  
21,0 cm, 8<sup>1</sup>/<sub>4</sub>"    **AK-1069-21**



**MIXTER**

17,0 cm, 6<sup>3</sup>/<sub>4</sub>"

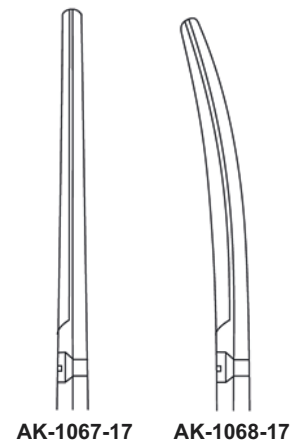



Präparierscheren, feine chirurgische Scheren  
DisseAKing Scissors, fine surgical scissors  
Tijeras de disección, tijeras finas para cirugía  
Forbici per dissezione, forbici fine per chirurgia



**KIAKER (RAGNELL)**

12,0 cm, 4 <sup>3</sup> / <sub>4</sub> "	<b>AK-1070-12</b>
15,0 cm, 6"	<b>AK-1070-15</b>
18,0 cm, 7"	<b>AK-1070-18</b>
20,0 cm, 8"	<b>AK-1070-20</b>



**KIAKER (RAGNELL)**

12,0 cm, 4 <sup>3</sup> / <sub>4</sub> "	<b>AK-1071-12</b>
15,0 cm, 6"	<b>AK-1071-15</b>
18,0 cm, 7"	<b>AK-1071-18</b>
20,0 cm, 8"	<b>AK-1071-20</b>



**REYNOLDS**

15,0 cm, 6"	<b>AK-1072-15</b>
18,0 cm, 7"	<b>AK-1072-18</b>



**REYNOLDS**

15,0 cm, 6"	<b>AK-1073-15</b>
18,0 cm, 7"	<b>AK-1073-18</b>
20,0 cm, 8"	<b>AK-1073-20</b>
23,0 cm, 9"	<b>AK-1073-23</b>
25,0 cm, 10"	<b>AK-1073-25</b>



Feine chirurgische Scheren  
Fine surgical scissors  
Tijeras finas para cirugía  
Forbici fine per chirurgia



**THOREK**



19,0 cm, 7 1/2"  
**AK-1074-19**

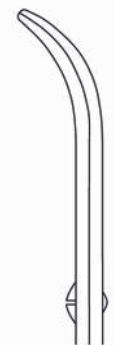

25,0 cm, 10"  
**AK-1075-25**



15,0 cm, 6"



**AK-1076-15**



**AK-1077-15**

Nerv-Präparierscheren  
Nerve dissection scissors  
Tijeras para nervios  
Forbici per dissezione di nervi



**SANVENERO**  
14,0 cm, 5 1/2"



**AK-1078-14**

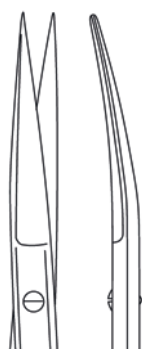

**AK-1079-14**



**JOSEPH**  
14,0 cm, 5 1/2"

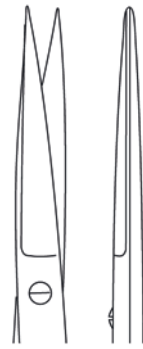

**AK-1080-14**



**AK-1081-14**



**Feine chirurgische Scheren**  
**Fine surgical scissors**  
**Tijeras finas para cirugía**  
**Forbici fine per chirurgia**



**WAGNER**  
12,0 cm, 4<sup>3</sup>/<sub>4</sub>"



**AK-1082-12**



**AK-1083-12**



**AK-1086-12**



**AK-1087-12**



**AKRABISMUS**  
11,5 cm, 4<sup>1</sup>/<sub>2</sub>"



**AK-1084-11**



**AK-1085-11**



**IRIS**

9,0 cm, 4<sup>1</sup>/<sub>8</sub>"  
10,5 cm, 4<sup>1</sup>/<sub>8</sub>"  
11,5 cm, 4<sup>1</sup>/<sub>2</sub>"

**AK-1088-09**  
**AK-1088-10**  
**AK-1088-11**



**IRIS**

9,0 cm, 4<sup>1</sup>/<sub>8</sub>"  
10,5 cm, 4<sup>1</sup>/<sub>8</sub>"  
11,5 cm, 4<sup>1</sup>/<sub>2</sub>"

**AK-1089-09**  
**AK-1089-10**  
**AK-1089-11**

Feine chirurgische Scheren  
Fine surgical scissors  
Tijeras finas para cirugía  
Forbici fine per chirurgia



**IRIS**

10,5 cm, 4<sup>1</sup>/<sub>8</sub>"  
11,5 cm, 4<sup>1</sup>/<sub>2</sub>"

**AK-1090-10**  
**AK-1090-11**



**IRIS**

10,5 cm, 4<sup>1</sup>/<sub>8</sub>"  
11,5 cm, 4<sup>1</sup>/<sub>2</sub>"

**AK-1091-10**  
**AK-1091-11**



11,5 cm, 4<sup>1</sup>/<sub>2</sub>"  
**AK-1092-11**



11,5 cm, 4<sup>1</sup>/<sub>2</sub>"  
**AK-1093-11**



Feine chirurgische Scheren  
Fine surgical scissors  
Tijeras finas para cirugía  
Forbici fine per chirurgia



**AK-1094-12**

12,0 cm, 4<sup>3</sup>/<sub>4</sub>"



**AK-1095-12**



**MOD. BONN**  
8,0 cm, 3<sup>1</sup>/<sub>4</sub>"  
**AK-1096-08**



**MOD. BONN**  
8,0 cm, 3<sup>1</sup>/<sub>4</sub>"  
**AK-1097-08**



**MOD. BONN**  
8,0 cm, 3<sup>1</sup>/<sub>4</sub>"  
**AK-1098-08**



Feine chirurgische Scheren  
Fine surgical scissors  
Tijeras finas para cirugía  
Forbici fine per chirurgia



**BROPHY (SULLIVAN)**  
14,0 cm, 5 1/2"  
AK-1099-14



**BROPHY (SULLIVAN)**  
14,0 cm, 5 1/2"  
AK-1100-14

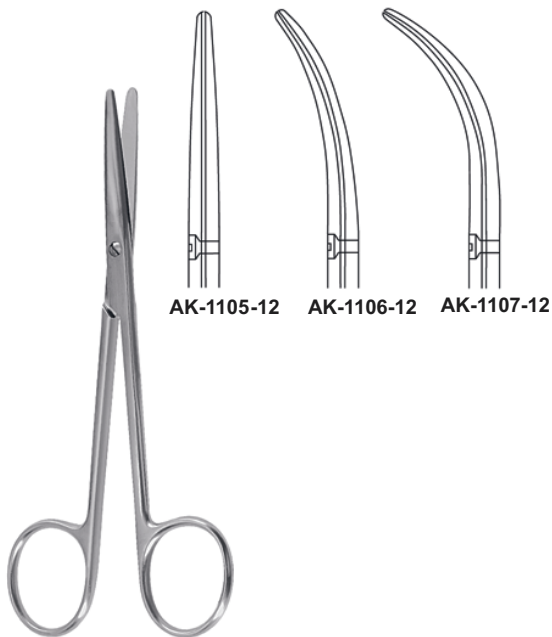

**LANDOLT**  
12,5 cm, 5"



**AKEVENS**

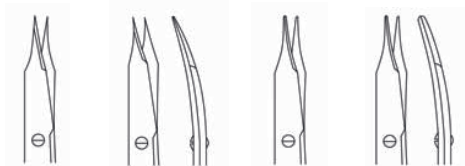

10,5 cm, 4 1/8" **AK-1101-10** **AK-1102-10** **AK-1103-10** **AK-1104-10**  
11,5 cm, 4 1/2" **AK-1101-11** **AK-1102-11** **AK-1103-11** **AK-1104-11**





**Chirurgische Scheren**  
**Surgical scissors**  
**Tijeras para cirugía**  
**Forbici per chirurgia**



Inzisionsscheren  
Incision scissors  
Tijeras para incisión  
Forbici vascolare e per fiAKole

13,0 cm, 5" **AK-1108-13**  
14,5 cm, 5<sup>3</sup>/<sub>4</sub>" **AK-1108-14**

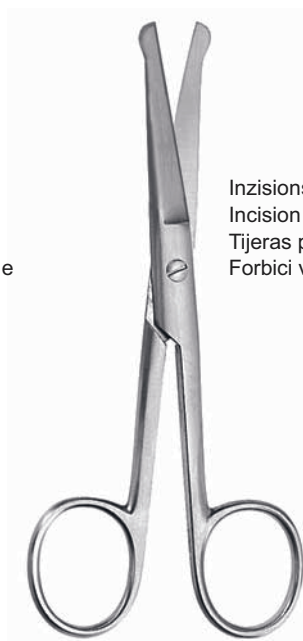

Inzisionsscheren  
Incision scissors  
Tijeras para incisión  
Forbici vascolare e per fi AKole

**AK-1109-16**  
16,5 cm, 36<sup>1</sup>/<sub>2</sub>"

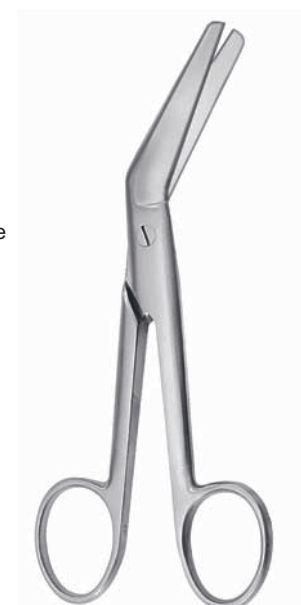

**RICHTER**  
14,5 cm, 5<sup>3</sup>/<sub>4</sub>"  
**AK-1110-14**



**LAWSON TAIT**  
12,5 cm, 5"  
**AK-1111-12**



**FERGUSON**  
16,5 cm, 6<sup>1</sup>/<sub>4</sub>" **AK-1112-16**  
18,0 cm, 7" **AK-1112-18**

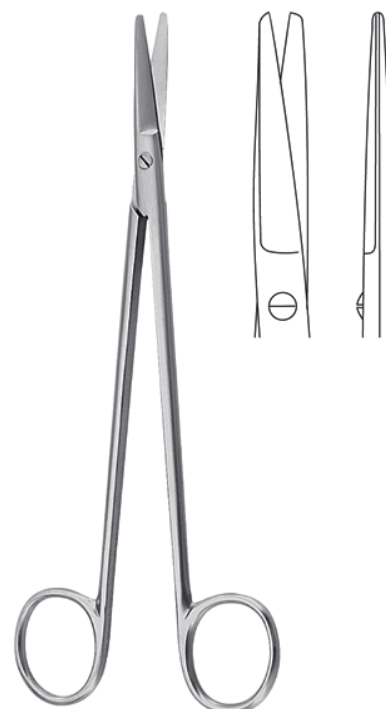

**TOENNIS**  
18,0 cm, 7"  
**AK-1113-18**



Chirurgische Scheren, Ligaturscheren  
Surgical scissors, Ligature Scissors  
Tijeras para cirugía, Tijeras para ligaduras  
Forbici per chirurgia, Forbici per legature

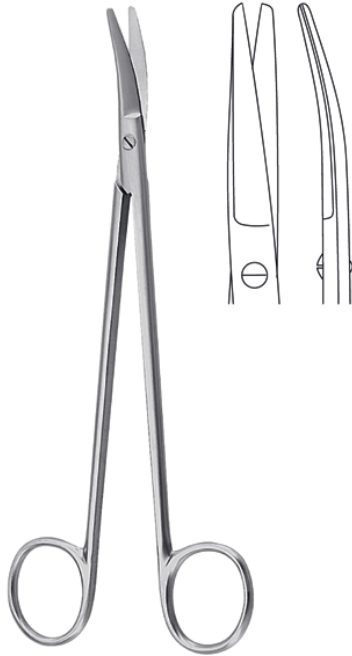

**TOENNIS**  
18,0 cm, 7"  
AK-1114-18



**HALLE**  
19,0 cm, 7 1/2"  
AK-1115-19



**FOMON**  
15,0 cm, 6"  
AK-1116-15



**SPENCER**  
9,0 cm, 4 1/8"    **AK-1117-09**  
10,5 cm, 4 1/8"    **AK-1117-10**  
13,0 cm, 5"        **AK-1117-13**



**LITTAUER**  
11,5 cm, 4 1/4"    **AK-1118-11**  
14,0 cm, 5 1/2"    **AK-1118-14**

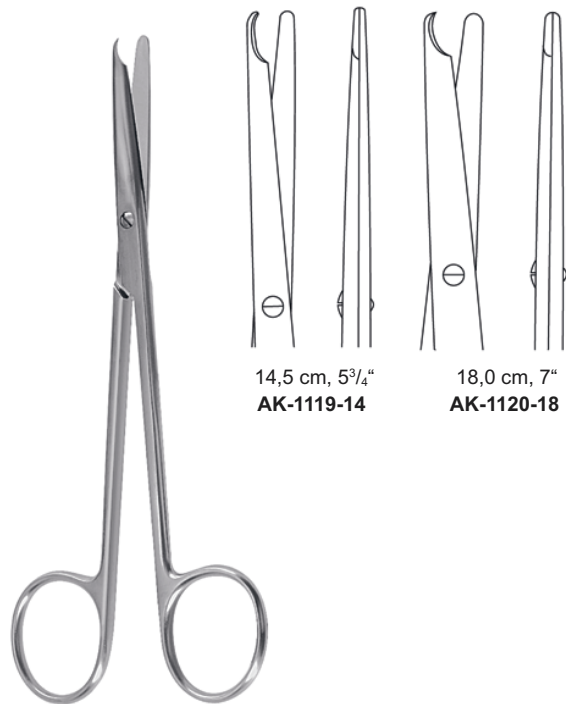

**BUCK**

14,5 cm, 5 3/4"  
**AK-1119-14**

18,0 cm, 7"  
**AK-1120-18**



**Ligaturscheren, Neurochirurgische Scheren**  
**Ligature Scissors, Neurosurgical Scissors**  
**Tijeras para ligaduras, Tijeras para Neurocirugía**  
**Forbici per legature, Forbici per Neurochirurgia**

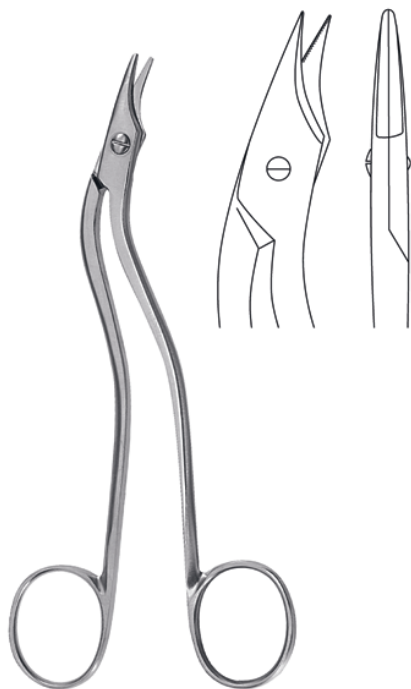

**HEATH**  
16,0 cm, 6<sup>1</sup>/<sub>4</sub>"  
AK-1121-16



**NOAKHBENT**  
9,0 cm, 3<sup>1</sup>/<sub>2</sub>"  
AK-1122-09



**NOAKHBENT**  
13,0 cm, 5"  
AK-1123-13



**EISELSBERG**  
12,0 cm, 4<sup>3</sup>/<sub>4</sub>"  
AK-1124-12

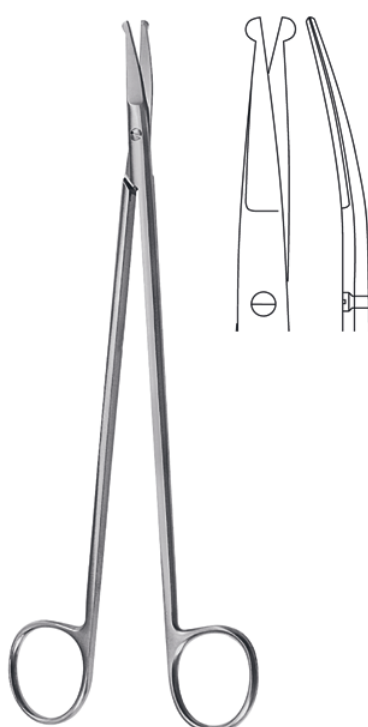

**AKRULLY**  
22,0 cm, 8<sup>5</sup>/<sub>8</sub>"  
AK-1125-22

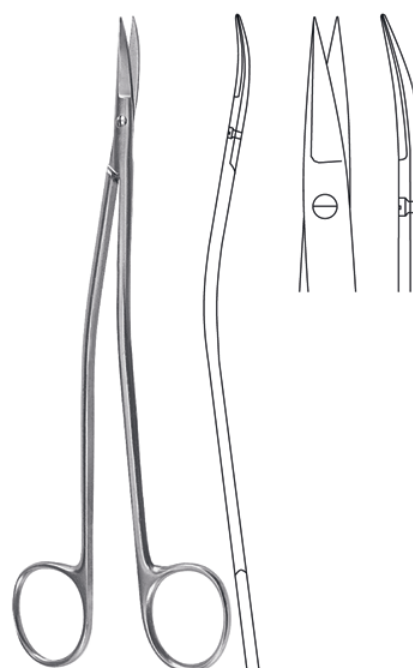

**DANDY**  
17,0 cm, 6<sup>3</sup>/<sub>4</sub>"  
AK-1126-17



Neurochirurgische Scheren, Tonsillenscheren, Nasenscheren  
Neurosurgical Scissors, Tonsil Scissors, Nasal Scissors  
Tijeras para Neurocirugía, Tijeras para amígdalas, Tijeras para el tabique nasal  
Forbici per Neurochirurgia, Forbici per tonsille, Forbici per il setto nasale

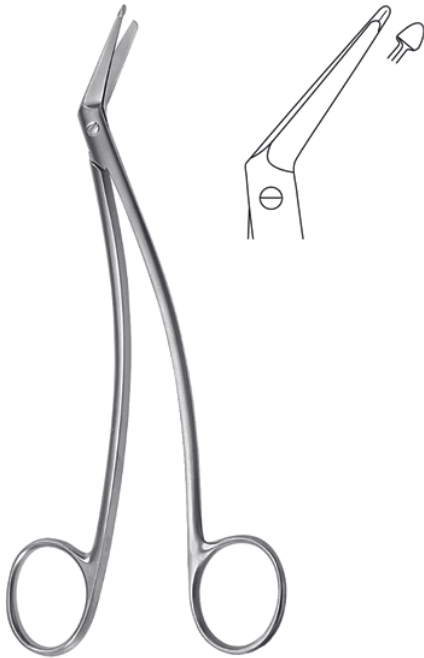

**SCHMIEDEN-TAYLOR**  
17,0 cm, 6<sup>3</sup>/<sub>4</sub>"  
AK-1127-17

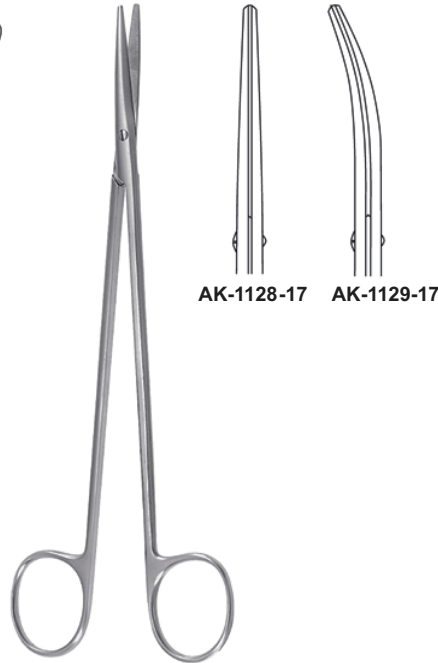

**LINCOAK**  
17,0 cm, 6<sup>3</sup>/<sub>4</sub>"



**HEYMANN**  
18,0 cm, 7"  
AK-1130-18



**COTTLE**  
16,0 cm, 6<sup>1</sup>/<sub>4</sub>"  
AK-1131-16

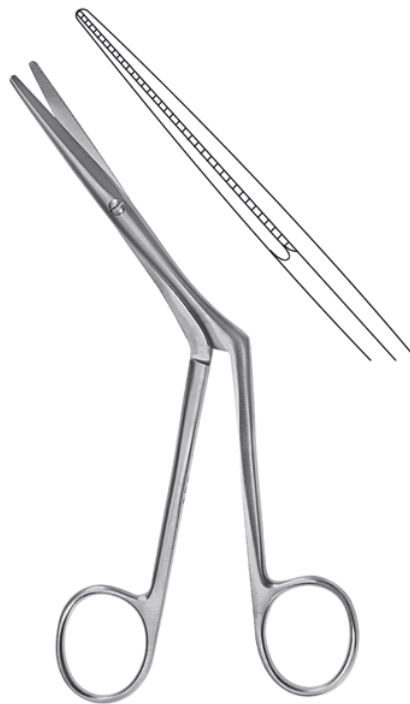

**KIRAKEN**  
18,0 cm, 7"  
AK-1132-18



**CAPLAN**  
22,0 cm, 8<sup>5</sup>/<sub>8</sub>"  
AK-1133-22



Tonsillenscheren, Nasenscheren, Gefäßscheren  
Tonsil Scissors, Nasal Scissors, Vascular Scissors  
Tijeras para amígdalas, Tijeras para el tabique nasal, Tijeras vasculares  
Forbici per tonsille, Forbici per il setto nasale, Forbici vascolari



**BOETTCHER**  
18,0 cm, 7"  
AK-1134-18



**PRINCE**  
17,5 cm, 6<sup>5</sup>/<sub>8</sub>"  
AK-1135-17

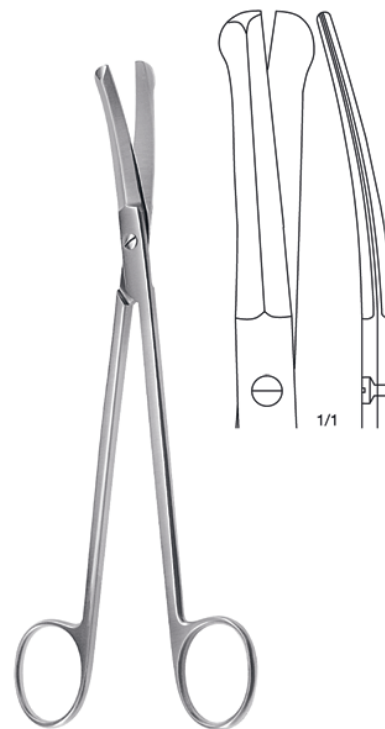

**GOOD**  
19,0 cm, 7<sup>1</sup>/<sub>2</sub>"  
AK-1136-19



**CAAKILAGE**  
20,0 cm, 8"  
AK-1137-20



**DE BAKEY**

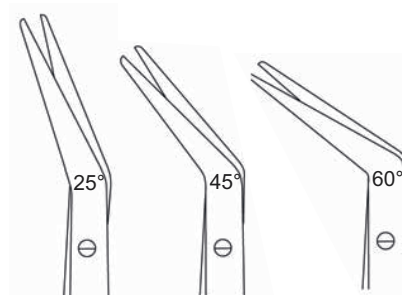

11

17,5 cm, 6 <sup>5</sup> / <sub>8</sub> "	AK-1138-25	AK-1143-45	AK-1148-60
19,5 cm, 7 <sup>3</sup> / <sub>4</sub> "	AK-1139-25	AK-1144-45	AK-1149-60
21,0 cm, 8 <sup>1</sup> / <sub>4</sub> "	AK-1140-25	AK-1145-45	AK-1150-60
23,0 cm, 9"	AK-1141-25	AK-1146-45	AK-1151-60
28,0 cm, 11"	AK-1142-25	AK-1147-45	AK-1152-60



Gefäßscheren  
Vascular Scissors  
Tijeras vasculares  
Forbici vascolari



**POTTS-SMITH**  
18,0 cm, 7"  
AK-1143-18

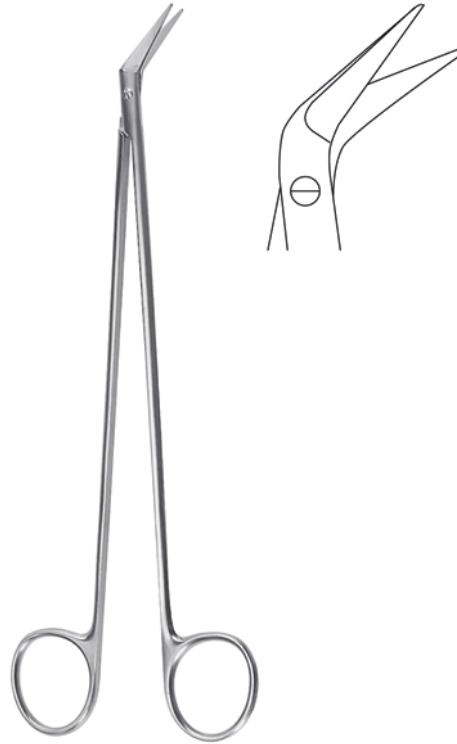

**POTTS DE MAAKEL**  
21,0 cm, 8<sup>1</sup>/<sub>4</sub>" **AK-1144-21**  
24,0 cm, 9<sup>1</sup>/<sub>2</sub>" **AK-1144-24**



**DIETRICH-HEGEMANN**  
19,0 cm, 7<sup>1</sup>/<sub>2</sub>"

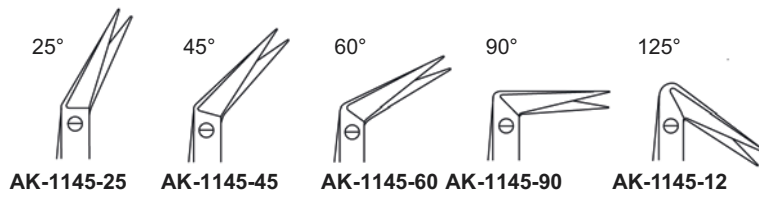



**Gefäßscheren**  
**Vascular Scissors**  
**Tijeras vasculares**  
**Forbici vascolari**



**DIETHRICH**  
20,0 cm, 7 1/2"  
AK-1148-12

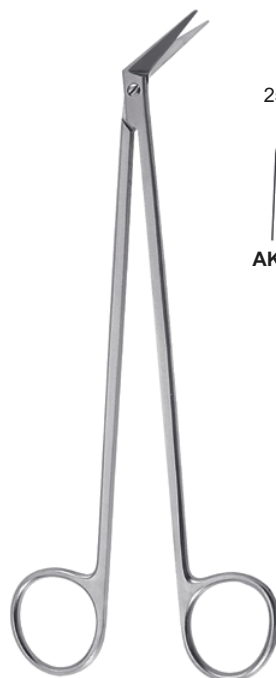

**POTTS-SMITH**  
19,0 cm, 7 1/2"

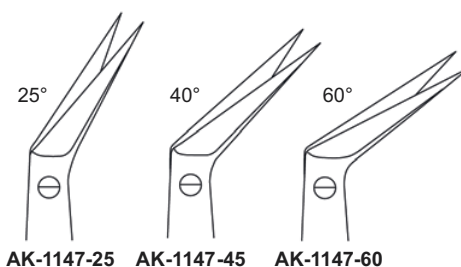

AK-1147-25    AK-1147-45    AK-1147-60

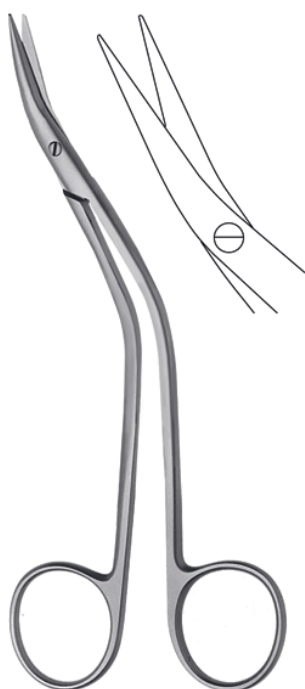

**DE BAKEY**  
15,5 cm, 6"  
AK-1149-15

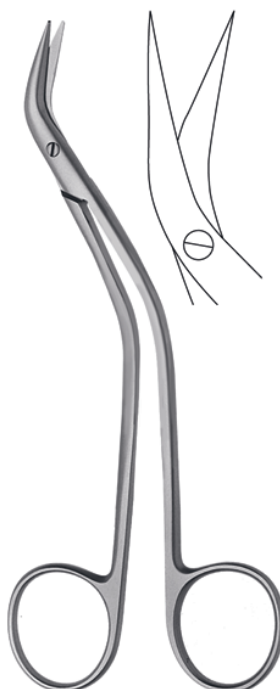

**DE BAKEY**  
15,5 cm, 6"  
AK-1150-15

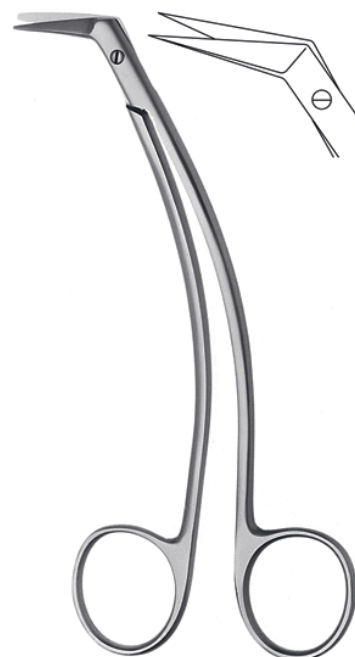

**DE BAKEY**  
15,5 cm, 6"  
AK-1151-15



**Gefäßscheren, Gynäkologische Scheren**  
**Vascular Scissors, Gynecology scissors**  
**Tijeras vasculares, Tijeras para ginecología**  
**Forbici vascolari, Forbici per ginecologia**



**MC INDOE**  
19,0 cm, 7½"  
AK-1152-19



geknöpftes Blatt  
probe-pointed blade  
punta botonda  
lame bottonuta

11,5 cm, 4½"  
AK-1153-11



**CRAFOORD**  
30,0 cm, 12"  
AK-1154-30



**SATINSKY**  
15,5 cm, 9⅝"  
AK-1155-24

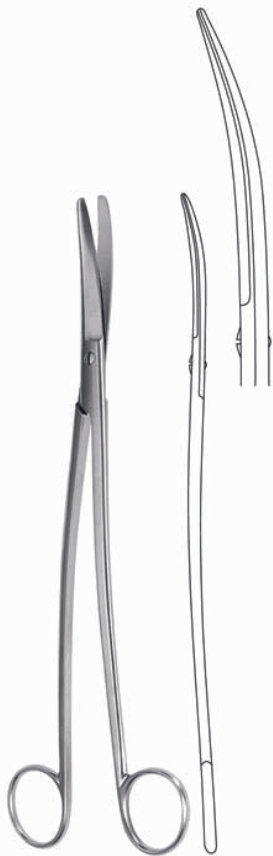

**KLINGENBERG-LOTH**  
23,0 cm, 9"  
AK-1162-23

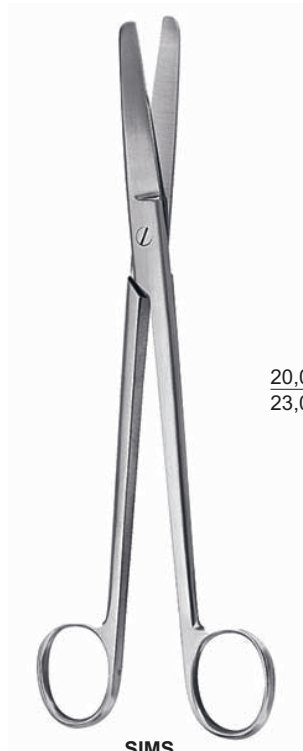

**SIMS**



20,0 cm, 8"	<b>AK-1156-20</b>	<b>AK-1157-20</b>	<b>AK-1158-20</b>
23,0 cm, 9"	<b>AK-1159-23</b>	<b>AK-1160-23</b>	<b>AK-1161-23</b>





**Gynäkologische Scheren**  
**Gynecology scissors**  
**Tijeras para ginecología**  
**Forbici per ginecologia**



**SIMS**

20,0 cm, 8"  
23,0 cm, 9"



**AK-1163-20 AK-1164-20 AK-1165 -20**  
**AK-1166-23 AK-1167-23 AK-1168 -23**

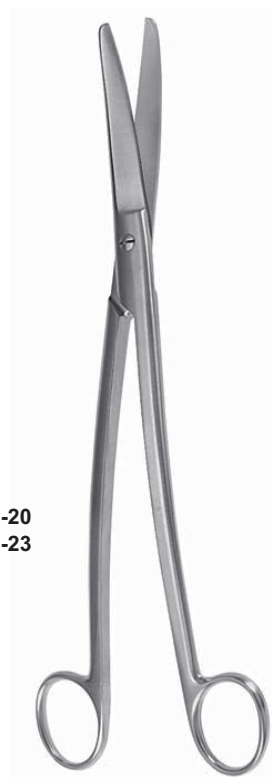

**SIEBOLD**  
24,0 cm, 9½"  
**AK-1169-24**



**BOZEMANN**  
22,0 cm, 8¾"  
**AK-1170-22**



**DOYEN**

16,0 cm, 6¼" **AK-1171-16 AK-1172-16 AK- 1173-16**  
17,5 cm, 6⅝" **AK-1174-17 AK-1175-17 AK-1176-16**



**KELLY**

16,0 cm, 6¼" **AK-1177-16**  
18,0 cm, 7" **AK-1177-18**

**FiAKelscheren**  
**FiAKula scissors**  
**Tijeras para fiAKulas**  
**Forbici per fiAKole**



Gynäkologische Scheren, Darmscheren  
Gynecology scissors, Enterotomy Scissors  
Tijeras para ginecología, Tijeras enterótomas  
Forbici per ginecologia, Forbici per enterotomia



FiAKelscheren  
FiAKula scissors  
Tijeras para fiAKulas  
Forbici per fiAKole

**KELLY**

16,0 cm, 6<sup>1</sup>/<sub>4</sub>" **AK-1179-16**  
18,0 cm, 7" **AK-1179-18**



**WEAKHEIM**

19,5 cm, 7<sup>3</sup>/<sub>4</sub>" **AK-1180-19**  
22,5 cm, 8<sup>3</sup>/<sub>4</sub>" **AK-1180-23**



**AK-1178-18**

**DUBOIS**

27,0 cm, 10<sup>5</sup>/<sub>8</sub>"  
**AK-1181-18**



**DARMSCHERE**  
21,0 cm, 8<sup>1</sup>/<sub>4</sub>"  
**AK-1182-21**



**DARMSCHERE**  
21,0 cm, 8<sup>1</sup>/<sub>4</sub>"  
**AK-1183-21**



**DARMSCHERE  
GEKNÖPFT**  
21,0 cm, 8<sup>1</sup>/<sub>4</sub>"  
**AK-1184-21**

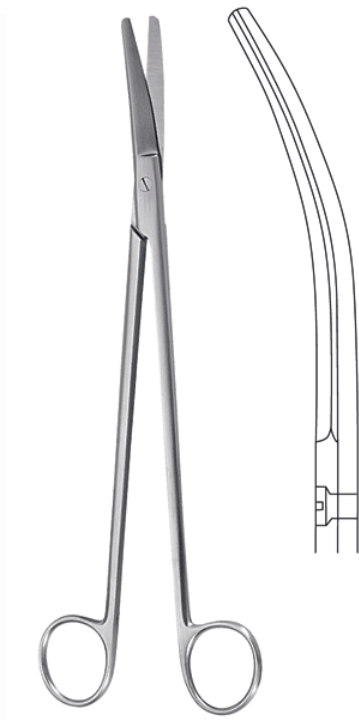

**LLOYD-DAVIES**  
27,0 cm, 10<sup>5</sup>/<sub>8</sub>"  
**AK-1185-27**



Lungenlappen- und Rektumscheren, Lungenscheren, Dammscheren  
LobeAKomy and ReAKal Scissors, LobeAKomy Scissors, Episiotomy Scissors  
Tijeras para lobeAKomía y reAKo, Tijera para lobeAKomía, Tijeras para episiotomía  
Forbici per lobo polmonare e per il retto, Forbici per lobo, Forbici per episiotomia



**ARELZNER**  
31,0 cm, 12<sup>1</sup>/<sub>4</sub>"

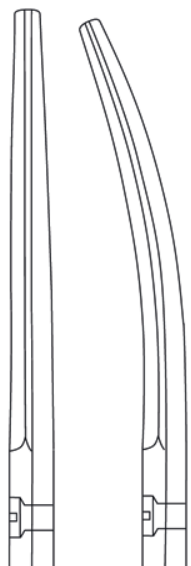

**AK-1186-31** **AK-1187-31**

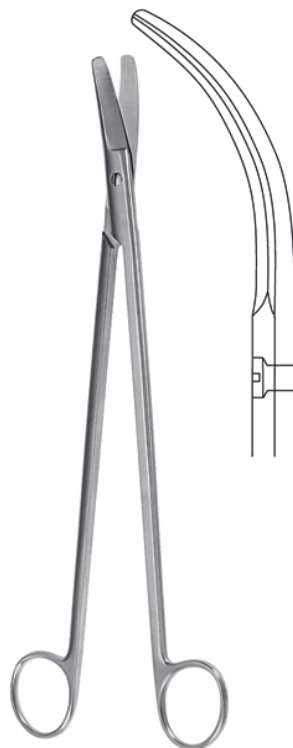

**REAKAL**  
32,5 cm, 12<sup>3</sup>/<sub>4</sub>"  
**AK-1188-32**

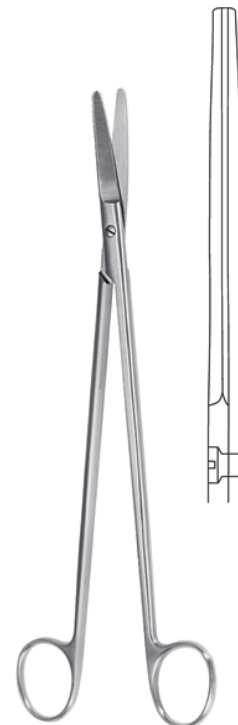

**WILLAUER**  
25,0 cm, 9<sup>3</sup>/<sub>4</sub>" **AK-1189-25**  
28,0 cm, 11" **AK-1189-28**

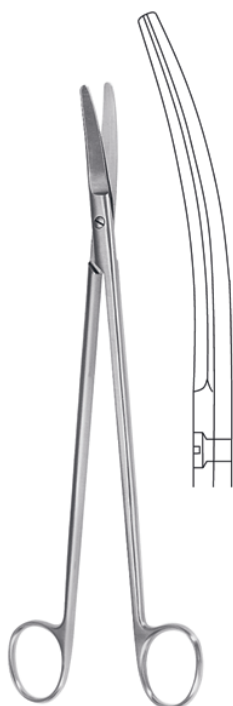

**WILLAUER**  
25,0 cm, 9<sup>3</sup>/<sub>4</sub>" **AK-1190-25**  
28,0 cm, 11" **AK-1190-28**



**POTTS-SMITH**  
19,0 cm, 7<sup>1</sup>/<sub>2</sub>"  
**AK-1191-19**

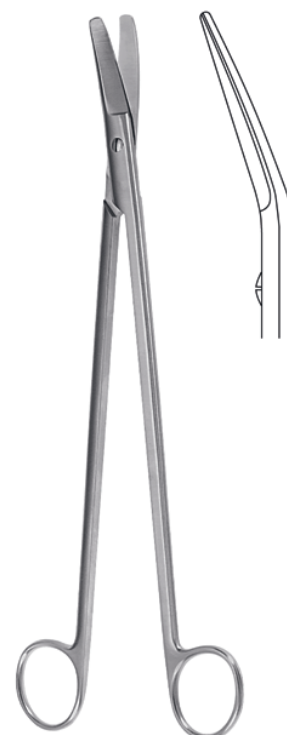

**FINOCHIETTO**  
32,5 cm, 10<sup>5</sup>/<sub>8</sub>"  
**AK-1192-27**



Lungenscheren, Dammscheren, Nabelschnurscheren  
LobeAKomy Scissors, Episiotomy Scissors, Umbilical Cord Scissors  
Tijera para lobeAKomía, Tijeras para episiotomía, Tijeras umbilicales  
Forbici per lobo, Forbici per episiotomia, Forbici ombelicali



**WALDMANN**  
18,0 cm, 7"  
AK-1193-18



**BRAUN-AKADLER**  
14,5 cm, 5<sup>3</sup>/<sub>4</sub>"      **AK-1194-14**  
20,0 cm, 8"         **AK-1194-20**



**EPISIOTOMIE SCHERE**  
20,0 cm, 8"  
AK-1195-20



**MOD. USA**  
10,5 cm, 4<sup>1</sup>/<sub>8</sub>"  
AK-1196-10



**BUSCH**  
13,5 cm, 5<sup>3</sup>/<sub>8</sub>"      **AK-1197-13**  
16,0 cm, 6<sup>1</sup>/<sub>4</sub>"     **AK-1197-16**



**SCHUMACHER**  
16,0 cm, 16<sup>1</sup>/<sub>4</sub>"  
AK-1198-16



**Drahtscheren, Verband- und KleiderAKoffscheren**  
**Wire Scissors, Bandage and Cloth Scissors**  
**Cizallas coAKa-alambres, Tijeras para vendajes y tela**  
**Forbici taglia cavo, Forbici per bendaggi e veAKiti**



gezahnt  
serrated  
dentada  
dentata

**UNIVERSAL**  
12,0 cm, 4 3/8"



**LIAKER**

9,0 cm, 3 1/2"	<b>AK-1199-09</b>
11,0 cm, 4 3/8"	<b>AK-1199-11</b>
14,0 cm, 5 1/2"	<b>AK-1199-14</b>
18,0 cm, 7"	<b>AK-1199-18</b>
20,0 cm, 8"	<b>AK-1199-20</b>



**LIAKER**

18,5 cm, 7 1/4"	<b>AK-1201-18</b>
21,0 cm, 8 1/4"	<b>AK-1201-21</b>



gezahnt  
serrated  
dentada  
dentata

**LIAKER-EXCENTRIC**

16,0 cm, 6 1/4"	<b>AK-1202-16</b>
19,0 cm, 7 1/2"	<b>AK-1202-19</b>



**BERGMANN**

23,0 cm, 9"	<b>AK-1203-23</b>
-------------	-------------------



**Verband- und KleiderAKoffscheren, Gipsscheren  
Bandage and Cloth Scissors, Plaster-of-Paris Shears  
Tijeras para vendajes y tela, Cizallas para escayolas  
Forbici per bendaggi e veAKiti, Cesoie per gessi**



**ESMARCH**  
20,0 cm, 8" **AK-1204-20**  
22,0 cm, 8<sup>5</sup>/<sub>8</sub>" **AK-1204-22**



**KNOWLES**  
14,0 cm, 5<sup>1</sup>/<sub>2</sub>" **AK-1205-14**

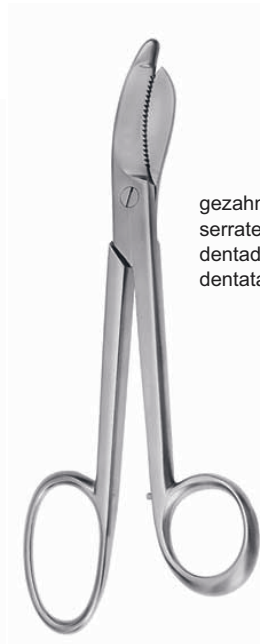

**BRUNS**  
24,0 cm, 9<sup>1</sup>/<sub>2</sub>" **AK-1206-24**  
**AK-1207-24**

gezahnt  
serrated  
dentada  
dentata



**LORENZ**  
23,0 cm, 9" **AK-1208-23**

bis 134°C autoklavierbar  
autoclavable up to 134°C  
eAKérilizable en autoclave haAKa 134°C  
AKerilizzabile in autoclave fino 134°C



**SMITH  
(MOD. USA)**

16,0 cm, 6<sup>1</sup>/<sub>4</sub>" **AK-1209-16**  
18,0 cm, 7" **AK-1209-18**  
20,0 cm, 8" **AK-1209-20**  
23,0 cm, 9" **AK-1209-23**



**GIPSSCHERE**  
20,0 cm, 8" **AK-1210-20**

gezahnt  
serrated  
dentada  
dentata



**UNIVERSAL**  
14,0 cm, 5<sup>1</sup>/<sub>2</sub>" **AK-1211-14**  
16,0 cm, 6<sup>1</sup>/<sub>4</sub>" **AK-1211-16**  
18,0 cm, 7" **AK-1211-18**

gezahnt  
serrated  
dentada  
dentata



**Chirurgische Scheren mit HaAKmetallschneiden**  
**Surgical Scissors with tungAKen carbide edges**  
**Tijeras para cirugía con filos de carburo tungAKeno**  
**Forbici per chirurgia con lame in carburo di tungAKeno**



**AKANDARD**  
14,5 cm, 5<sup>3</sup>/<sub>4</sub>" **AK-1212-14-TC**  
16,5 cm, 6<sup>1</sup>/<sub>2</sub>" **AK-1212-16-TC**  
18,5 cm, 7<sup>1</sup>/<sub>4</sub>" **AK-1212-18-TC**



**AKANDARD**  
14,5 cm, 5<sup>3</sup>/<sub>4</sub>" **AK-1213-14-TC**  
16,5 cm, 6<sup>1</sup>/<sub>2</sub>" **AK-1213-16-TC**  
18,5 cm, 7<sup>1</sup>/<sub>4</sub>" **AK-1213-18-TC**



**AKANDARD**  
14,5 cm, 5<sup>3</sup>/<sub>4</sub>" **AK-1214-14-TC**  
16,5 cm, 6<sup>1</sup>/<sub>2</sub>" **AK-1214-16-TC**  
18,5 cm, 7<sup>1</sup>/<sub>4</sub>" **AK-1214-18-TC**



**AKANDARD**  
14,5 cm, 5<sup>3</sup>/<sub>4</sub>" **AK-1215-14-TC**  
16,5 cm, 6<sup>1</sup>/<sub>2</sub>" **AK-1215-16-TC**  
18,5 cm, 7<sup>1</sup>/<sub>4</sub>" **AK-1215-18-TC**



**AKANDARD**  
14,5 cm, 5<sup>3</sup>/<sub>4</sub>" **AK-1216-14-TC**  
16,5 cm, 6<sup>1</sup>/<sub>2</sub>" **AK-1216-16-TC**  
18,5 cm, 7<sup>1</sup>/<sub>4</sub>" **AK-1216-18-TC**



**AKANDARD**  
14,5 cm, 5<sup>3</sup>/<sub>4</sub>" **AK-1217-14-TC**  
16,5 cm, 6<sup>1</sup>/<sub>2</sub>" **AK-1217-16-TC**  
18,5 cm, 7<sup>1</sup>/<sub>4</sub>" **AK-1217-18-TC**



Chirurgische Scheren mit HaAKmetallschneiden  
Surgical Scissors with tungAKen carbide edges  
Tijeras para cirugía con filos de carburo tungAKeno  
Forbici per chirurgia con lame in carburo di tungAKeno



**MAYO**

14,5 cm, 5 <sup>3</sup> / <sub>4</sub> "	<b>AK-1218-14-TC</b>
17,0 cm, 6 <sup>3</sup> / <sub>4</sub> "	<b>AK-1218-17-TC</b>
23,0 cm, 9"	<b>AK-1218-23-TC</b>



**MAYO**

14,5 cm, 5 <sup>3</sup> / <sub>4</sub> "	<b>AK-1219-14-TC</b>
17,0 cm, 6 <sup>3</sup> / <sub>4</sub> "	<b>AK-1219-17-TC</b>
23,0 cm, 9"	<b>AK-1219-23-TC</b>



**MAYO-AKILLE**

15,0 cm, 6"	<b>AK-1220-15-TC</b>
17,0 cm, 6 <sup>3</sup> / <sub>4</sub> "	<b>AK-1220-17-TC</b>



**MAYO-AKILLE**

15,0 cm, 6"	<b>AK-1221-15-TC</b>
17,0 cm, 6 <sup>3</sup> / <sub>4</sub> "	<b>AK-1221-17-TC</b>



**LEXER**

16,0 cm, 6 <sup>1</sup> / <sub>4</sub> "	<b>AK-1222-16-TC</b>
21,0 cm, 8 <sup>1</sup> / <sub>4</sub> "	<b>AK-1222-21-TC</b>



**LEXER**

16,0 cm, 6 <sup>1</sup> / <sub>4</sub> "	<b>AK-1223-16-TC</b>
21,0 cm, 8 <sup>1</sup> / <sub>4</sub> "	<b>AK-1223-21-TC</b>





**Präparierscheren mit HaAKmetallschneiden**  
**Dissecting Scissors with tungsten carbide edges**  
**Tijeras para disección con filos de carburo tungsteno**  
**Forbici per dissezione con lame in carburo di tungsteno**

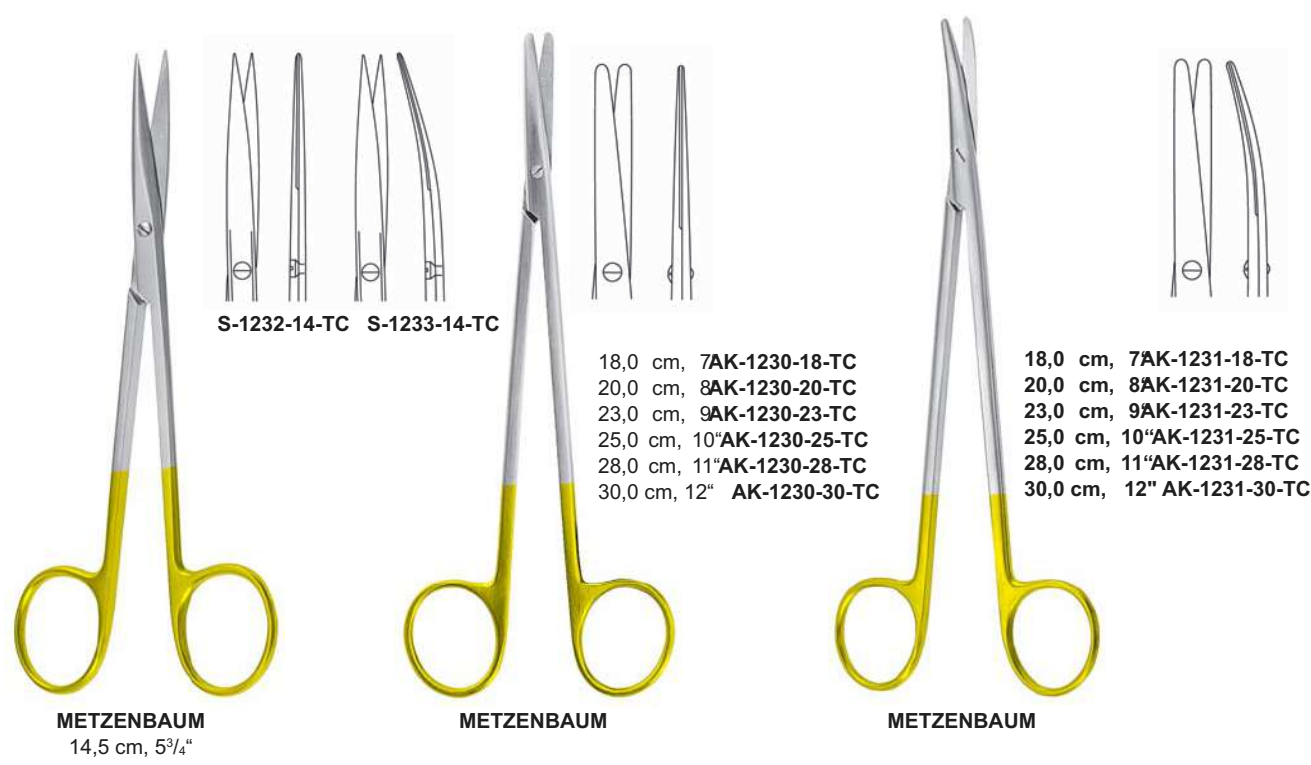
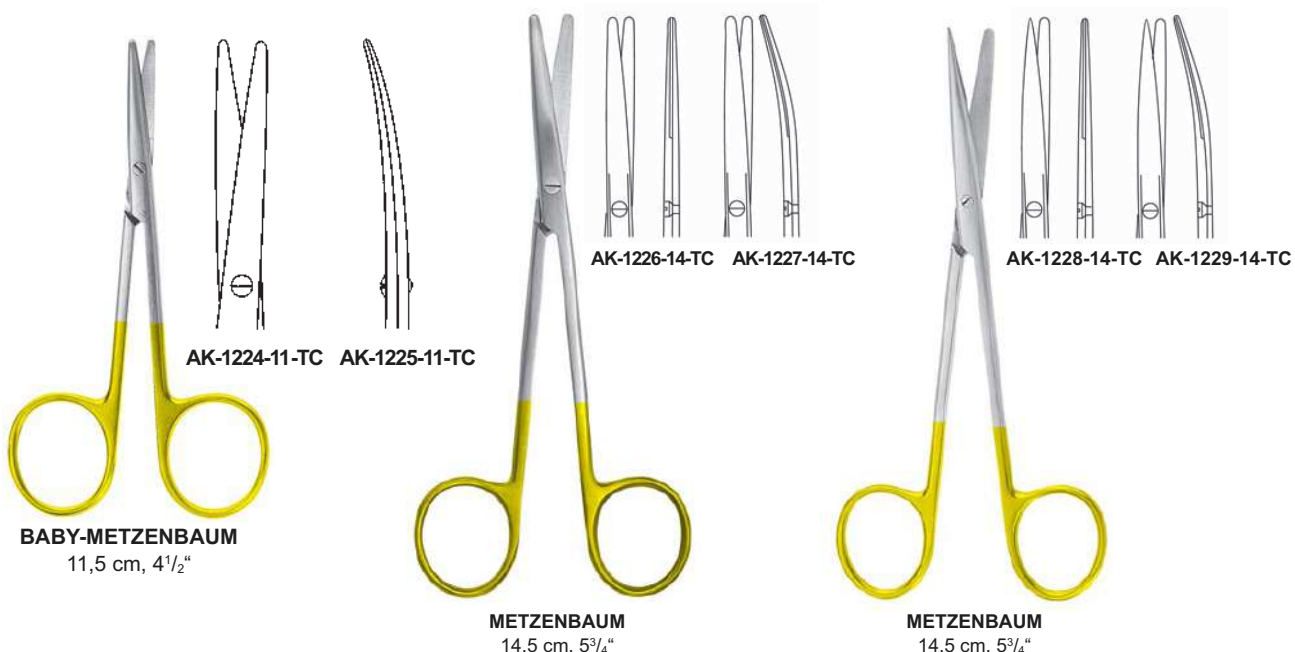

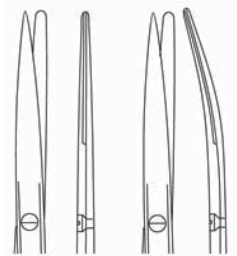

18,0 cm, 7AK-1234-18-TC  
20,0 cm, 8AK-1234-20-TC  
23,0 cm, 9AK-1234-23-TC  
25,0 cm, 10AK-1234-25-TC  
28,0 cm, 11AK-1234-28-TC  
30,0 cm, 12AK-1234-30-TC

**METZENBAUM**

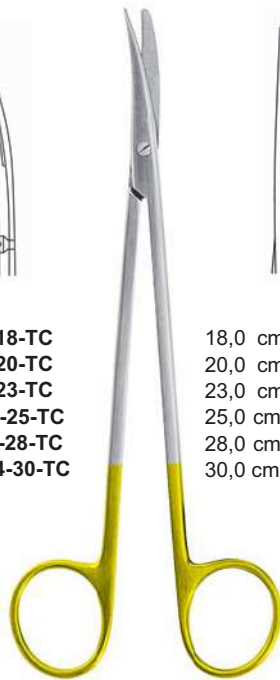

18,0 cm, 7AK-1235-18-TC  
20,0 cm, 8AK-1235-20-TC  
23,0 cm, 9AK-1235-23-TC  
25,0 cm, 10AK-1235-25-TC  
28,0 cm, 11AK-1235-28-TC  
30,0 cm, 12AK-1235-30-TC

**METZENBAUM**

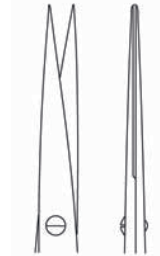
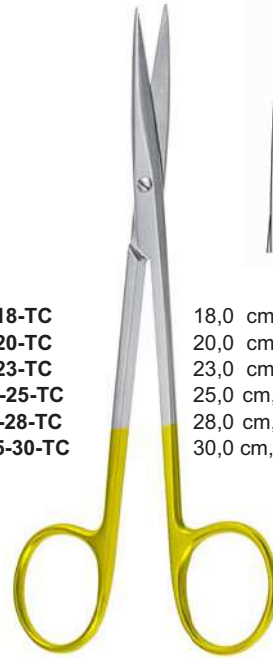

18,0 cm, 7AK-1236-18-TC  
20,0 cm, 8AK-1236-20-TC  
23,0 cm, 9AK-1236-23-TC  
25,0 cm, 10AK-1236-25-TC  
28,0 cm, 11AK-1236-28-TC  
30,0 cm, 12AK-1236-30-TC

**METZENBAUM**



18,0 cm, 7AK-1237-18-TC  
20,0 cm, 8AK-1237-20-TC  
23,0 cm, 9AK-1237-23-TC  
25,0 cm, 10AK-1237-25-TC  
28,0 cm, 11AK-1237-28-TC  
30,0 cm, 12AK-1237-30-TC

**METZENBAUM**

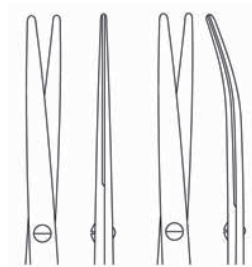

AK-1238-14-TC AK-1239-14-TC

**METZENBAUM-FINO**  
14,5 cm, 5<sup>3</sup>/<sub>4</sub>"

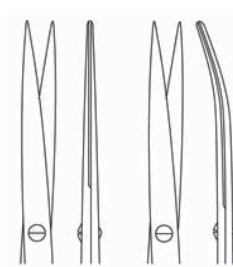

AK-1240-14-TC AK-1241-14-TC

**METZENBAUM-FINO**  
14,5 cm, 5<sup>3</sup>/<sub>4</sub>"



**Präparierscheren mit HaAKmetallschneiden**  
**DisseAKing Scissors with tungAKen carbide edges**  
**Tijeras para disección con filos de carburo tungAKeno**  
**Forbici per dissezione con lame in carburo di tungAKeno**

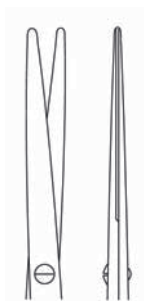

18,0 cm, 7" **AK-1242-18-TC**  
20,0 cm, 8" **AK-1242-20-TC**  
23,0 cm, 9" **AK-1242-23-TC**  
25,0 cm, 10" **AK-1242-25-TC**  
28,0 cm, 11" **AK-1242-28-TC**  
30,0 cm, 12" **AK-1242-30-TC**

**METZENBAUM-FINO**

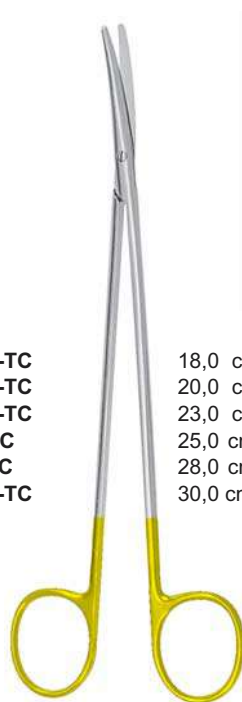

18,0 cm, 7" **AK-1243-18-TC**  
20,0 cm, 8" **AK-1243-20-TC**  
23,0 cm, 9" **AK-1243-23-TC**  
25,0 cm, 10" **AK-1243-25-TC**  
28,0 cm, 11" **AK-1243-28-TC**  
30,0 cm, 12" **AK-1243-30-TC**

**METZENBAUM-FINO**

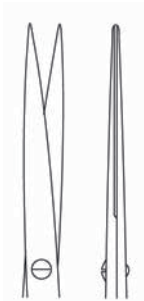

18,0 cm, 7" **AK-1244-18-TC**  
20,0 cm, 8" **AK-1244-20-TC**  
23,0 cm, 9" **AK-1244-23-TC**  
25,0 cm, 10" **AK-1244-25-TC**  
28,0 cm, 11" **AK-1244-28-TC**  
30,0 cm, 12" **AK-1244-30-TC**

**METZENBAUM-FINO**



18,0 cm, 7" **AK-1245-18-TC**  
20,0 cm, 8" **AK-1245-20-TC**  
23,0 cm, 9" **AK-1245-23-TC**  
25,0 cm, 10" **AK-1245-25-TC**  
28,0 cm, 11" **AK-1245-28-TC**  
30,0 cm, 12" **AK-1245-30-TC**

**METZENBAUM-FINO**

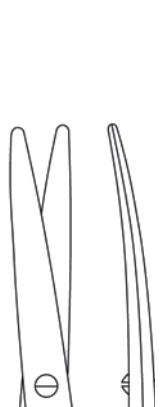

**METZENBAUM-LAHEY**  
14,0 cm, 5 1/2"  
**AK-1246-14-TC**



**TOENNIS-ADSON**  
17,0 cm, 6 3/4"  
**AK-1247-17-TC**

Präparierscheren mit HaAKmetallschneiden  
DisseAKing Scissors with tungAKen carbide edges  
Tijeras para disección con filos de carburo tungAKeno  
Forbici per dissezione con lame in carburo di tungAKeno



18,0 cm, 7" AK-1248-18-TC  
20,0 cm, 8" AK-1248-20-TC  
23,0 cm, 9" AK-1248-23-TC

**METZENBAUM-FINO S**



18,0 cm, 7" AK-1249-18-TC  
20,0 cm, 8" AK-1249-20-TC  
23,0 cm, 9" AK-1249-23-TC

**METZENBAUM-FINO S**



**REYNOLDS**  
15,0 cm, 6"  
AK-1250-15-TC



**REYNOLDS**  
15,0 cm, 6"  
AK-1251-15-TC



**HYAKEREKTOMY**  
25,5 cm, 10"  
AK-1252-25-TC



**HYAKEREKTOM Y**  
25,0 cm, 9<sup>3</sup>/<sub>4</sub>"  
AK-1253-25-TC



Gynäkologische Scheren mit HaAKmetallschneiden  
Gynecology Scissors with tungAKen carbide edges  
Tijeras para ginecología con filos de carburo tungAKeno  
Forbici per ginecologia con lame in carburo di tungAKeno



**SIMS**

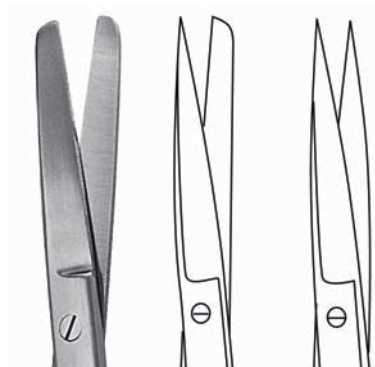

20,0 cm, 8" **AK-1254-20-TC** **AK-1255-20-TC** **AK-1256-20-TC**  
23,0 cm, 9" **AK-1254-23-TC** **AK-1255-23-TC** **AK-1256-23-TC**



**SIMS**



20,0 cm, 8" **AK-1257-20-TC** **AK-1258-20-TC** **AK-1259-20-TC**  
23,0 cm, 9" **AK-1257-23-TC** **AK-1258-23-TC** **AK-1259-23-TC**



**Gefäßscheren mit HaAKmetallschneiden**  
**Vascular Scissors with tungAKen carbide edges**  
**Tijeras vasculares con filos de carburo tungAKeno**  
**Forbici vascolari con lame in carburo di tungAKeno**



**DIETRICH**  
17,5 cm, 6<sup>5</sup>/<sub>8</sub>"  
AK-1260-17-TC



**POTTS DE MAAKEL**  
24,0 cm, 9<sup>1</sup>/<sub>2</sub>"  
AK-1261-24-TC



**DE BAKEY**

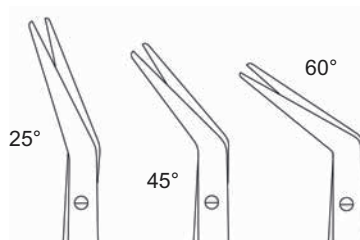

20,0 cm, 8" **AK-1262-25-TC** **AK-1264-45-TC** **AK-1266-60-TC**  
23,0 cm, 9" **AK-1263-25-TC** **AK-1265-45-TC** **AK-1267-60-TC**



**Gefäßscheren mit HaAKmetallschneiden**  
**Vascular Scissors with tungAKen carbide edges**  
**Tijeras vasculares con filos de carburo tungAKeno**  
**Forbici vascolari con lame in carburo di tungAKeno**



**DIETHRICH-HEGEMANN**  
18,0 cm, 7"

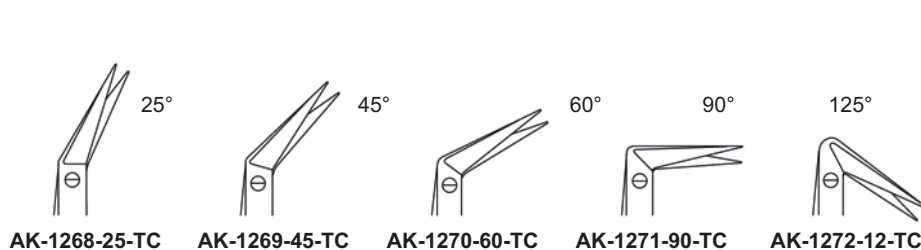

AK-1268-25-TC

AK-1269-45-TC

AK-1270-60-TC

AK-1271-90-TC

AK-1272-12-TC

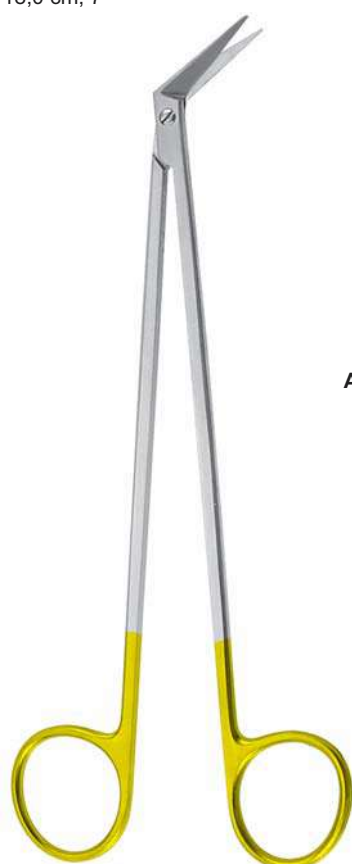

**POTTS-SMITH**  
18,0 cm, 7 1/2"

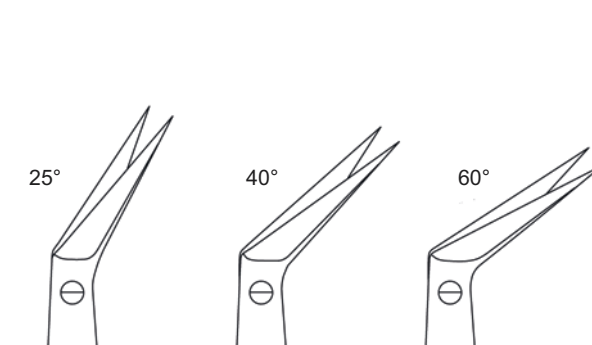

AK-1273-25-TC

AK-1274-45-TC

AK-1275-60-TC



Scheren mit HaAKmetallschneiden  
Scissors with tungAKen carbide edges  
Tijeras con filos de carburo tungAKeno  
Forbici con lame in carburo di tungAKeno

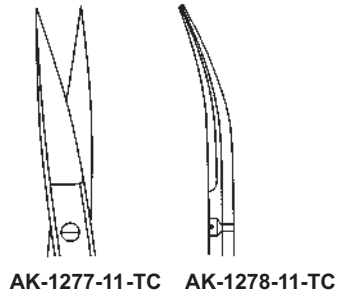

**IRIS**  
11,5 cm, 4 1/2"

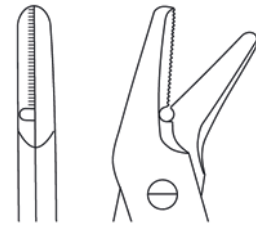

gezahnt  
serrated  
dentada  
dentata

**UNIVERSAL**  
12,0 cm, 4 3/4"  
AK-1279-12-TC



**LIAKER**  
18,0 cm, 7"  
AK-1280-18-TC

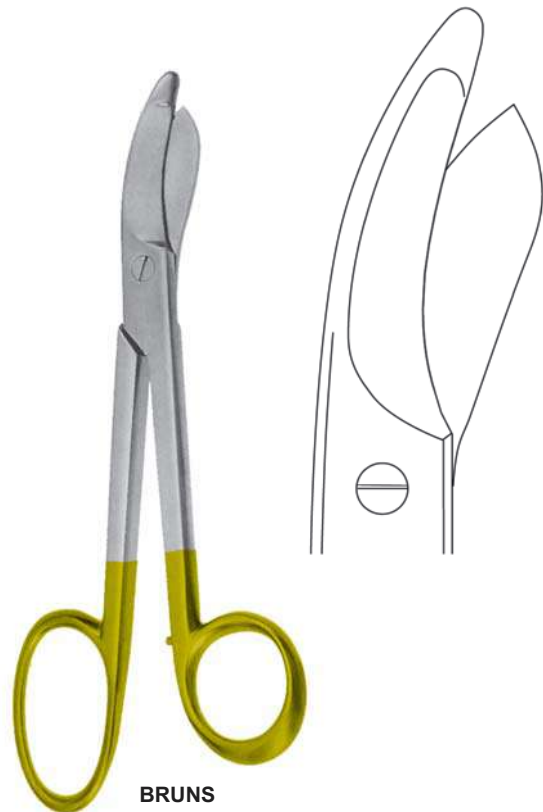

**BRUNS**  
24,0 cm, 9 1/2"  
AK-1281-24-TC





**Super-Cut Scheren  
Super-Cut Scissors  
Tijeras Super-Cut  
Forbici Super-Cut**



**MAYO**  
17,0 cm, 6<sup>3</sup>/<sub>4</sub>"

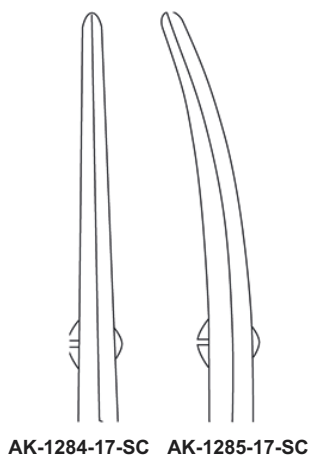

AK-1284-17-SC AK-1285-17-SC



**METZENBAUM**

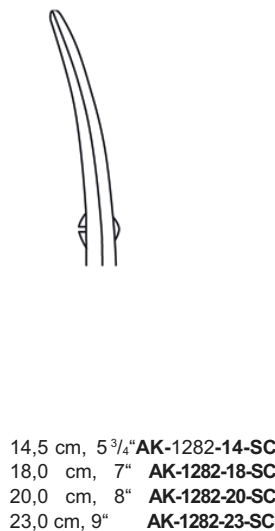

14,5 cm, 5<sup>3</sup>/<sub>4</sub>" AK-1282-14-SC  
18,0 cm, 7" AK-1282-18-SC  
20,0 cm, 8" AK-1282-20-SC  
23,0 cm, 9" AK-1282-23-SC

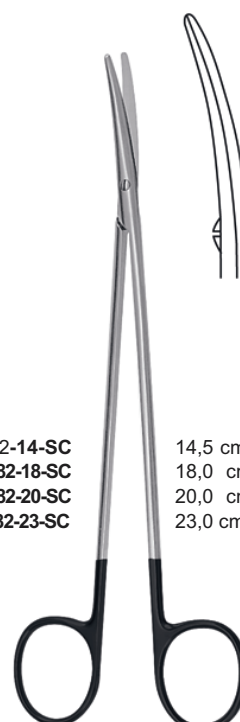

**METZENBAUM-FINO**

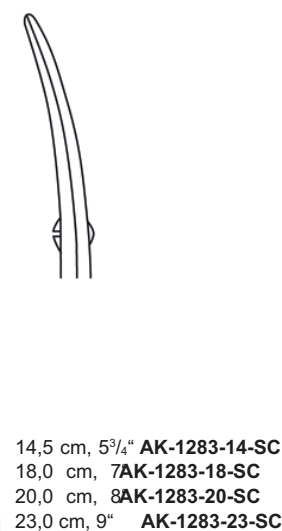

14,5 cm, 5<sup>3</sup>/<sub>4</sub>" AK-1283-14-SC  
18,0 cm, 7" AK-1283-18-SC  
20,0 cm, 8" AK-1283-20-SC  
23,0 cm, 9" AK-1283-23-SC



**KAYE FACE LIFT**

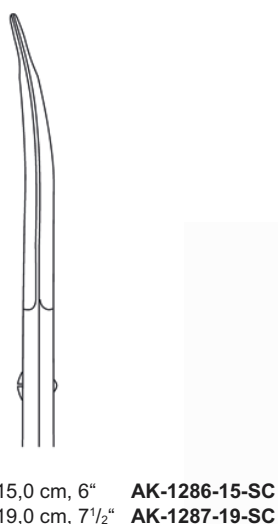

15,0 cm, 6" AK-1286-15-SC  
19,0 cm, 7<sup>1</sup>/<sub>2</sub>" AK-1287-19-SC



**JABALEY**  
13,0 cm, 5"  
AK-1288-13-SC



**ENDAKEREAKOMY**  
18,0 cm, 7"  
AK-1289-18-SC



**TOENNIS-ADSON**  
17,0 cm, 6<sup>3</sup>/<sub>4</sub>"  
AK-1290-17-SC



Super-Cut Scheren  
Super-Cut Scissors  
Tijeras Super-Cut  
Forbici Super-Cut



**AKRABISMUS**  
11,5 cm, 4 1/2"



**JAMISON**  
15,0 cm, 6"  
18,0 cm, 7"  
**AK-1293-15-SC**  
**AK-1293-18-SC**



**REYNOLDS**  
12,5 cm, 5"  
**AK-1294-12-SC**



**BABY-METZENBAUM**  
11,0 cm, 4 3/8"  
14,5 cm, 5 3/4"  
**AK-1295-11-SC**  
**AK-1295-14-SC**



**IRIS**  
11,0 cm, 4 3/8"  
**AK-1296-11-SC**



**IRIS**  
11,0 cm, 4 3/8"  
**AK-1297-11-SC**



**AKEVENS TENOTOMY**  
11,0 cm, 4 3/8"  
**AK-1298-11-SC**



**AKEVENS TENOTOMY**  
11,0 cm, 4 3/8"  
**AK-1299-11-SC**



**Super-Cut Scheren  
Super-Cut Scissors  
Tijeras Super-Cut  
Forbici Super-Cut**



**PAR TYPE**  
12,0 cm, 4<sup>3</sup>/<sub>4</sub>"  
**AK-1303-12-SC**



**PAR TYPE**  
12,0 cm, 4<sup>3</sup>/<sub>4</sub>"  
**AK-1304-12-SC**



**POTTS**  
19,0 cm, 7<sup>1</sup>/<sub>2</sub>"



**AK-1300-25-SC**



**AK-1301-45-SC**

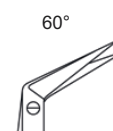

**AK-1302-60-SC**

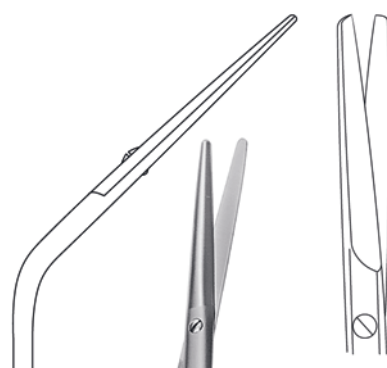

**FOMON**  
14,5 cm, 5<sup>3</sup>/<sub>4</sub>"  
**AK-1305-15-SC**

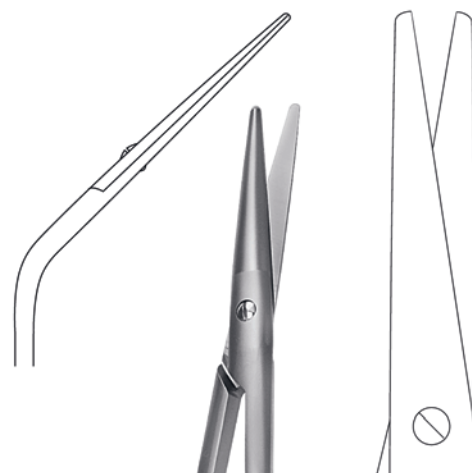

**COTTLE**  
16,5 cm, 6<sup>1</sup>/<sub>2</sub>"  
**AK-1306-16-SC**



**Mikro-Scheren  
Micro Scissors  
Micro-Tijeras  
Micro-Forbici**



**WEAKCOTT**  
11,0 cm, 4<sup>3</sup>/<sub>8</sub>"

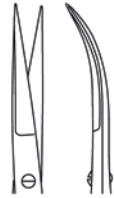

**AK-1307-11-M**

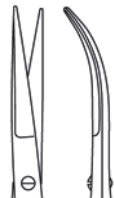

**AK-1308-11-M**



**GOMEL**

14,0 cm, 5<sup>1</sup>/<sub>2</sub>" **AK-1312-14-M**  
16,0 cm, 6<sup>1</sup>/<sub>4</sub>" **AK-1312-16-M**



gezahnt  
serrated  
dentada  
dentata



**HEPP SCHEIDEL**

14,0 cm, 5<sup>1</sup>/<sub>2</sub>" **AK-1313-14-M**  
16,0 cm, 6<sup>1</sup>/<sub>4</sub>" **AK-1313-16-M**



Mikro-Präparierscheren  
Micro.disseAKing scissors  
Micro-tijeras de disección  
Micro-forbici per dissezione

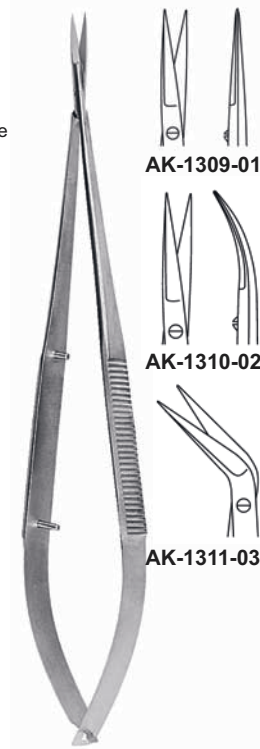

**AK-1309-01-M**

**AK-1310-02-M**

**AK-1311-03-M**

18,5 cm, 7<sup>1</sup>/<sub>4</sub>"



**SIMS**



18,5 cm, 7<sup>1</sup>/<sub>4</sub>" **AK-1314-01** **AK-1315-02** **AK-1316-03** **AK-1318-04**  
22,5 cm, 8<sup>3</sup>/<sub>4</sub>" **AK-1319-01** **AK-1320-02** **AK-1321-03** **AK-1322-04**

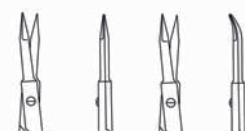

18,5 cm, 7<sup>1</sup>/<sub>4</sub>" **AK-1323-01-M** **AK-1325-02-M**  
22,5 cm, 8<sup>3</sup>/<sub>4</sub>" **AK-1324-01-M** **AK-1326-02-M**



**Mikro-Scheren, Mikro-Disektionsscheren**  
**Micro Scissors, Micro Dissection Scissors**  
**Micro-Tijeras, Micro-Tijeras de disección**  
**Micro-Forbici, Micro-Forbici per dissezione**



18,0 cm, 7"



AK-1327-25-M



AK-1328-45-M

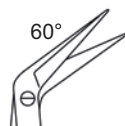

AK-1329-60-M

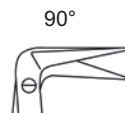

AK-1330-90-M



AK-1331-12-M



AK-1332-25-M



AK-1333-45-M

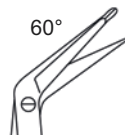

AK-1334-60-M

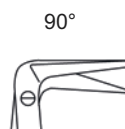

AK-1335-90-M



AK-1336-12-M



15,0 cm, 6"  
AK-1337-15-M



15,0 cm, 6"  
AK-1338-15-M



gezahnt  
serrated  
dentada  
dentata



15,0 cm, 6"  
AK-1339-15-M



18,0 cm, 7"  
AK-1340-18-M



**Mikro-Adventitiascheren  
Micro Adventitia Scissors  
Micro-Tijeras Adventitia  
Micro-Forbici Adventitia**



15,0 cm, 6"  
AK-1341-15-M



15,0 cm, 6"  
AK-1342-15-M



gezahnt  
serrated  
dentada  
dentata



15,0 cm, 6"  
AK-1343-15-M



18,0 cm, 7"  
AK-1344-18-M





**VASE** INSTRUMENTS  
PREMIUM QUALITY INSTRUMENTS

**Pinzetten**  
**Forceps**  
**Pinzas**  
**Pinze**





**Anatomische Pinzetten**  
**Dissecting Forceps**  
**Pinzas de disección**  
**Pinze anatomiche per dissezione**



schmal  
narrow  
eAKrechos  
AKretti



schmal  
narrow  
eAKrechos  
AKretti



fein  
fine  
finas  
fni

**AKANDARD**

10,5 cm, 4 <sup>1</sup> / <sub>8</sub> "	<b>AK-1345-10</b>
11,5 cm, 4 <sup>1</sup> / <sub>2</sub> "	<b>AK-1345-11</b>
13,0 cm, 5"	<b>AK-1345-13</b>
14,5 cm, 5 <sup>3</sup> / <sub>4</sub> "	<b>AK-1345-14</b>
15,0 cm, 6"	<b>AK-1345-15</b>
16,0 cm, 6 <sup>1</sup> / <sub>4</sub> "	<b>AK-1345-16</b>
18,0 cm, 7"	<b>AK-1345-18</b>
20,0 cm, 8"	<b>AK-1345-20</b>
25,0 cm, 10"	<b>AK-1345-25</b>
30,0 cm, 12"	<b>AK-1345-30</b>

**AKANDARD**

10,5 cm, 4 <sup>1</sup> / <sub>8</sub> "	<b>AK-1346-10</b>
11,5 cm, 4 <sup>1</sup> / <sub>2</sub> "	<b>AK-1346-11</b>
13,0 cm, 5"	<b>AK-1346-13</b>
14,5 cm, 5 <sup>3</sup> / <sub>4</sub> "	<b>AK-1346-14</b>
15,0 cm, 6"	<b>AK-1346-15</b>
16,0 cm, 6 <sup>1</sup> / <sub>4</sub> "	<b>AK-1346-16</b>
18,0 cm, 7"	<b>AK-1346-18</b>
20,0 cm, 8"	<b>AK-1346-20</b>
25,0 cm, 10"	<b>AK-1346-25</b>
30,0 cm, 12"	<b>AK-1346-30</b>

**AKANDARD**

10,5 cm, 4 <sup>1</sup> / <sub>8</sub> "	<b>AK-1347-10</b>
11,5 cm, 4 <sup>1</sup> / <sub>2</sub> "	<b>AK-1347-11</b>
13,0 cm, 5"	<b>AK-1347-13</b>
14,5 cm, 5 <sup>3</sup> / <sub>4</sub> "	<b>AK-1347-14</b>
15,0 cm, 6"	<b>AK-1347-15</b>
16,0 cm, 6 <sup>1</sup> / <sub>4</sub> "	<b>AK-1347-16</b>
18,0 cm, 7"	<b>AK-1347-18</b>
20,0 cm, 8"	<b>AK-1347-20</b>
25,0 cm, 10"	<b>AK-1347-25</b>
30,0 cm, 12"	<b>AK-1347-30</b>

**AKANDARD**

10,5 cm, 4 <sup>1</sup> / <sub>8</sub> "	<b>AK-1348-10</b>
11,5 cm, 4 <sup>1</sup> / <sub>2</sub> "	<b>AK-1348-11</b>
13,0 cm, 5"	<b>AK-1348-13</b>
14,5 cm, 5 <sup>3</sup> / <sub>4</sub> "	<b>AK-1348-14</b>
15,0 cm, 6"	<b>AK-1348-15</b>
16,0 cm, 6 <sup>1</sup> / <sub>4</sub> "	<b>AK-1348-16</b>
18,0 cm, 7"	<b>AK-1348-18</b>
20,0 cm, 8"	<b>AK-1348-20</b>
25,0 cm, 10"	<b>AK-1348-25</b>
30,0 cm, 12"	<b>AK-1348-30</b>



Anatomische Pinzetten  
Dissecting Forceps  
Pinzas de disección  
Pinze anatomiche per dissezione



fein  
fine  
finas  
fni



fein  
fine  
finas  
fni

mit AKift  
with pin  
con peAKo  
con espiga



schma  
narrow  
eAKre  
AKrett

10,5 cm, 4<sup>1</sup>/<sub>8</sub>" **AK-1349-10**  
11,5 cm, 4<sup>1</sup>/<sub>2</sub>" **AK-1349-11**  
13,0 cm, 5" **AK-1349-13**  
14,5 cm, 5<sup>3</sup>/<sub>4</sub>" **AK-1349-14**  
16,0 cm, 6<sup>1</sup>/<sub>4</sub>" **AK-1349-16**  
18,0 cm, 7" **AK-1349-18**  
20,0 cm, 8" **AK-1349-20**  
25,0 cm, 10" **AK-1349-25**  
30,0 cm, 12" **AK-1349-30**

10,5 cm, 4<sup>1</sup>/<sub>8</sub>" **AK-1350-10**  
11,5 cm, 4<sup>1</sup>/<sub>2</sub>" **AK-1350-11**  
13,0 cm, 5" **AK-1350-13**  
14,5 cm, 5<sup>3</sup>/<sub>4</sub>" **AK-1350-14**  
16,0 cm, 6<sup>1</sup>/<sub>4</sub>" **AK-1350-16**  
18,0 cm, 7" **AK-1350-18**  
20,0 cm, 8" **AK-1350-20**  
25,0 cm, 10" **AK-1350-25**  
30,0 cm, 12" **AK-1350-30**

**MOD. USA**

12,0 cm, 4<sup>3</sup>/<sub>4</sub>" **AK-1351-10**  
13,0 cm, 5" **AK-1351-11**  
14,5 cm, 5<sup>3</sup>/<sub>4</sub>" **AK-1351-14**  
15,0 cm, 6" **AK-1351-15**  
18,0 cm, 7" **AK-1351-18**  
20,0 cm, 8" **AK-1351-20**  
25,5 cm, 10" **AK-1351-25**  
30,0 cm, 12" **AK-1351-30**

**MOD. USA**

12,0 cm, 4<sup>3</sup>/<sub>4</sub>" **AK-1352-11**  
13,0 cm, 5" **AK-1352-13**  
14,5 cm, 5<sup>3</sup>/<sub>4</sub>" **AK-1352-14**  
15,0 cm, 6" **AK-1352-15**  
18,0 cm, 7" **AK-1352-18**  
20,0 cm, 8" **AK-1352-20**  
25,5 cm, 10" **AK-1352-25**



Anatomische Pinzetten  
DisseAKing Forceps  
Pinzas de disección  
Pinze anatomiche per dissezione



**ADSON**  
12,0 cm, 4<sup>3</sup>/<sub>4</sub>" **AK-1353-12**  
15,0 cm, 6" **AK-1353-15**



**MICRO-ADSON**  
12,0 cm, 4<sup>3</sup>/<sub>4</sub>" **AK-1354-12**  
15,0 cm, 6" **AK-1354-15**



**AKILLE**  
15,0 cm, 6"  
**AK-1355-15**



**MC INDOE**  
15,0 cm, 6"  
**AK-1356-15**



**TAYLOR**  
17,5 cm, 6<sup>5</sup>/<sub>8</sub>"  
**AK-1357-17**



**TAYLOR**  
17,5 cm, 6<sup>5</sup>/<sub>8</sub>"  
**AK-1358-17**



**TAYLOR**  
18,5 cm, 7<sup>1</sup>/<sub>4</sub>"  
**AK-1359-18**



**GERALD**  
18,0 cm, 7"  
**AK-1360-18**



**GERALD**  
18,0 cm, 7"  
**AK-1361-18**



**POTTS-SMITH**  
18,0 cm, 7" **AK-1362-18**  
21,0 cm, 8<sup>1</sup>/<sub>4</sub>" **AK-1362-21**  
25,0 cm, 10" **AK-1362-25**



**POTTS-SMITH**  
18,0 cm, 7" **AK-1363-18**  
21,0 cm, 8<sup>1</sup>/<sub>4</sub>" **AK-1363-21**  
25,0 cm, 10" **AK-1363-25**



**Anatomische Pinzetten**  
**Disseking Forceps**  
**Pinzas de disección**  
**Pinze anatomiche per dissezione**

englische Modelle  
english patteAAK  
modelos ingleses  
modellii inglese

13,0 cm, 5" **AK-1364-13**  
14,5 cm, 5<sup>3</sup>/<sub>4</sub>" **AK-1364-14**  
15,0 cm, 6" **AK-1364-15**



**SEMKEN**  
12,5 cm, 5" **AK-1365-12**  
15,0 cm, 6" **AK-1365-15**



**CUSHING**  
17,5 cm, 6<sup>5</sup>/<sub>8</sub>"  
**AK-1366-17**



**CUSHING**  
17,5 cm, 6<sup>5</sup>/<sub>8</sub>"  
**AK-1367-17**



**BROPHY**  
20,0 cm, 8"  
**AK-1368-20**



Anatomische Pinzetten  
DisseAKing Forceps  
Pinzas de disección  
Pinze anatomiche per dissezione



**BROPHY**  
20,0 cm, 8"  
AK-1369-20



**BONNEY**  
18,0 cm, 7"  
AK-1370-18



**SINGLE-TUTTLE**  
23,0 cm, 9"  
AK-1371-23



**DENNIS BROWN**  
20,0 cm, 8"  
AK-1372-20

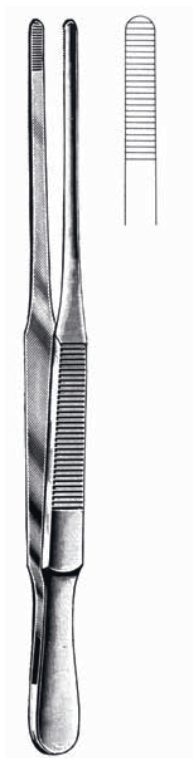

**DUEHRSEN**  
20,0 cm, 8"  
AK-1373-20



**WAUGH**  
15,0 cm, 6" **AK-1374-15**  
20,0 cm, 8" **AK-1374-20**



**RAMSEY**  
18,0 cm, 7"  
AK-1375-18



Chirurgische Pinzetten  
Tissue Forceps  
Pinzas quirúrgicas  
Pinze per chirurgia

 4 x 5



- 13,0 cm, 5" **AK-1379-13**
- 14,5 cm, 5<sup>3</sup>/<sub>4</sub>" **AK-1379-14**
- 16,0 cm, 6<sup>1</sup>/<sub>4</sub>" **AK-1379-16**
- 18,0 cm, 7" **AK-1379-18**
- 20,0 cm, 8" **AK-1379-20**

 1 x 2



**AKANDARD**

- 10,5 cm, 4<sup>1</sup>/<sub>8</sub>" **AK-1376-10**
- 11,5 cm, 4<sup>1</sup>/<sub>2</sub>" **AK-1376-11**
- 13,0 cm, 5" **AK-1376-13**
- 14,5 cm, 5<sup>3</sup>/<sub>4</sub>" **AK-1376-14**
- 15,0 cm, 6" **AK-1376-15**
- 16,0 cm, 6<sup>1</sup>/<sub>4</sub>" **AK-1376-16**
- 18,0 cm, 7" **AK-1376-18**
- 20,0 cm, 8" **AK-1376-20**
- 25,0 cm, 10" **AK-1376-25**
- 30,0 cm, 12" **AK-1376-30**

 2 x 3



- 11,5 cm, 4<sup>1</sup>/<sub>2</sub>" **AK-1377-11**
- 13,0 cm, 5" **AK-1377-13**
- 14,5 cm, 5<sup>3</sup>/<sub>4</sub>" **AK-1377-14**
- 16,0 cm, 6<sup>1</sup>/<sub>4</sub>" **AK-1377-16**
- 18,0 cm, 7" **AK-1377-18**
- 20,0 cm, 8" **AK-1377-20**
- 25,0 cm, 10" **AK-1377-25**
- 30,0 cm, 12" **AK-1377-30**

 3 x 4



- 13,0 cm, 5" **AK-1378-13**
- 14,5 cm, 5<sup>3</sup>/<sub>4</sub>" **AK-1378-14**
- 16,0 cm, 6<sup>1</sup>/<sub>4</sub>" **AK-1378-16**
- 18,0 cm, 7" **AK-1378-18**
- 20,0 cm, 8" **AK-1378-20**



Chirurgische Pinzetten  
Tissue Forceps  
Pinzas quirúrgicas  
Pinze per chirurgia



englische Modelle  
english patteAAK  
modelos ingleses  
modelli inglese

13,0 cm, 5" **AK-1236-13**  
14,5 cm, 5<sup>3</sup>/<sub>4</sub>" **AK-1236-14**  
15,0 cm, 6" **AK-1236-15**



fein  
fne  
finas  
fni

13,0 cm, 5" **AK-1380-13**  
14,5 cm, 5<sup>3</sup>/<sub>4</sub>" **AK-1380-14**  
15,5 cm, 6" **AK-1380-15**  
16,0 cm, 6<sup>1</sup>/<sub>4</sub>" **AK-1380-16**  
18,0 cm, 7" **AK-1380-18**  
20,0 cm, 8" **AK-1380-20**  
25,0 cm, 10" **AK-1380-25**  
30,0 cm, 12" **AK-1380-30**



mit AKift  
with pin  
con peAKo  
con espiga

13,0 cm, 5" **AK-1218-13**  
14,5 cm, 5<sup>3</sup>/<sub>4</sub>" **AK-1218-14**  
15,5 cm, 6" **AK-1218-15**  
16,0 cm, 6<sup>1</sup>/<sub>4</sub>" **AK-1218-16**  
18,0 cm, 7" **AK-1218-18**  
20,0 cm, 8" **AK-1218-20**  
25,0 cm, 10" **AK-1218-25**  
30,0 cm, 12" **AK-121-30**



mit AKift  
with pin  
con peAKo  
con espiga

13,0 cm, 5" **AK-1219-13**  
14,5 cm, 5<sup>3</sup>/<sub>4</sub>" **AK-1219-14**  
16,0 cm, 6<sup>1</sup>/<sub>4</sub>" **TF-1219-16**  
18,0 cm, 7" **AK-1219-18**  
20,0 cm, 8" **AK-1219-20**



MOD. USA	
12,0 cm, 4 <sup>3</sup> / <sub>4</sub> "	<b>AK-1206-12</b>
13,0 cm, 5"	<b>AK-1206-13</b>
14,5 cm, 5 <sup>3</sup> / <sub>4</sub> "	<b>AK-1206-14</b>
15,5 cm, 6"	<b>AK-1206-15</b>
18,0 cm, 7"	<b>AK-1206-18</b>
20,0 cm, 8"	<b>AK-1206-20</b>
25,0 cm, 10"	<b>AK-1206-25</b>
30,0 cm, 12"	<b>AK-1206-30</b>



MOD. USA	
12,0 cm, 4 <sup>3</sup> / <sub>4</sub> "	<b>AK-1212-12</b>
13,0 cm, 5"	<b>AK-1212-13</b>
14,5 cm, 5 <sup>3</sup> / <sub>4</sub> "	<b>AK-1212-14</b>
15,5 cm, 6"	<b>AK-1212-15</b>
18,0 cm, 7"	<b>AK-1212-18</b>
20,0 cm, 8"	<b>AK-1212-20</b>
25,0 cm, 10"	<b>AK-1212-25</b>
30,0 cm, 12"	<b>AK-1212-30</b>



ADSON	
12,0 cm, 4 <sup>3</sup> / <sub>4</sub> "	<b>AK-1270-12</b>
15,0 cm, 6"	<b>AK-1270-15</b>



MICRO-ADSON	
12,0 cm, 4 <sup>3</sup> / <sub>4</sub> "	<b>AK-1276-12</b>
15,0 cm, 6"	<b>AK-1276-15</b>



Chirurgische Pinzetten  
Tissue Forceps  
Pinzas quirúrgicas  
Pinze per chirurgia

2 x 3



**ADSON**  
12,0 cm, 4<sup>3</sup>/<sub>4</sub>" **AK-1074-12**  
15,0 cm, 6" **AK-1074-15**

1 x 2



**ADSON-BROWN**  
12,0 cm, 4<sup>3</sup>/<sub>4</sub>" **AK-1288-12**  
15,0 cm, 6" **TF-1288-15**



**ADSON**  
12,0 cm, 4<sup>3</sup>/<sub>4</sub>" **AK-1282-12**

1 x 2



**AKILLE**  
15,0 cm, 6" **AK-1208-15**

2 x 3



**AKILLE**  
15,0 cm, 6" **AK-1209-15**

1 x 2



**GILLIES**  
15,0 cm, 6" **AK-1300-15**

2 x 3



**ADLERKREUTZ**  
15,0 cm, 6" **AK-1382-15**  
20,0 cm, 8" **AK-1382-20**

4 x 5



**ADLERKREUTZ**  
15,0 cm, 6" **AK-1384-15**  
20,0 cm, 8" **AK-1384-20**





Chirurgische Pinzetten  
Tissue Forceps  
Pinzas quirúrgicas  
Pinze per chirurgia



**SEMKEN**  
12,5 cm, 5" **AK-1240-12**  
15,5 cm, 6" **AK-1240-15**



**SEMKEN**  
12,5 cm, 5" **AK-1242-12**



**MC INDOE**  
15,0 cm, 6" **AK-1358-15**



**TAYLOR**  
17,5 cm, 6<sup>5</sup>/<sub>8</sub>" **AK-1314-17**



**TAYLOR**  
17,5 cm, 6<sup>5</sup>/<sub>8</sub>" **AK-1315-17**



**TAYLOR**  
17,5 cm, 6<sup>5</sup>/<sub>8</sub>" **AK-1317-17**



**GERALD**  
18,0 cm, 7" **AK-1302-18**



**GERALD**  
18,0 cm, 7" **AK-1303-18**



**Chirurgische Pinzetten**  
**Tissue Forceps**  
**Pinzas quirúrgicas**  
**Pinze per chirurgia**



**CUSHING**  
17,5 cm, 6<sup>5</sup>/<sub>8</sub>"  
AK-1292-17



**CUSHING**  
17,5 cm, 6<sup>5</sup>/<sub>8</sub>"  
AK-1293-17



**POTTS-SMITH**  
18,0 cm, 7"  
21,0 cm, 8<sup>1</sup>/<sub>4</sub>"  
25,0 cm, 10"  
AK-1226-18  
AK-1226-21  
AK-1226-25



**POTTS-SMITH**  
18,0 cm, 7"  
21,0 cm, 8<sup>1</sup>/<sub>4</sub>"  
25,0 cm, 10"  
AK-1227-18  
AK-1227-21  
AK-1227-25



**WAUGH**  
15,0 cm, 6"  
20,0 cm, 8"  
AK-1330-15  
AK-1330-20



**BROPHY**  
20,0 cm, 8"  
AK-1294-20



**BROPHY**  
20,0 cm, 8"  
AK-1295-20



**RUSS. MODELL**  
15,0 cm, 6"  
20,0 cm, 8"  
25,0 cm, 10"  
AK-1456-15  
AK-1456-20  
AK-1456-25



Chirurgische Pinzetten  
Tissue Forceps  
Pinzas quirúrgicas  
Pinze per chirurgia



**DURANTE**  
14,5 cm, 5<sup>3</sup>/<sub>4</sub>" **AK-1460-14**  
16,0 cm, 6<sup>1</sup>/<sub>4</sub>" **AK-1460-16**  
20,0 cm, 8" **AK-1460-20**



**DUEHRSEN**  
20,0 cm, 8"

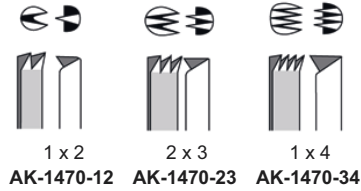

**NELSON**  
15,0 cm, 6" **AK-1518-15**  
20,0 cm, 8" **AK-1518-20**  
23,0 cm, 9" **AK-1518-23**



**DUVAL**  
14,0 cm, 5<sup>1</sup>/<sub>2</sub>"

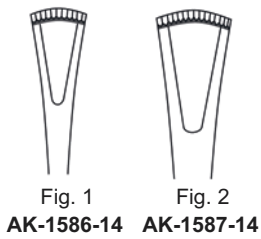

**COLLIN-DUVAL**  
20,0 cm, 8"

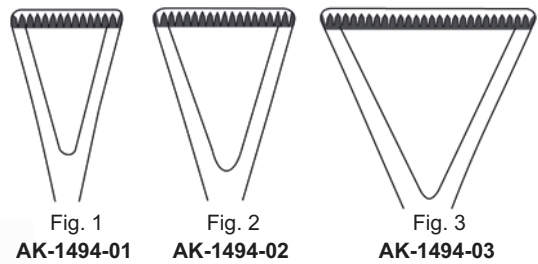



Chirurgische Pinzetten  
Tissue Forceps  
Pinzas quirúrgicas  
Pinze per chirurgia



**LANE**  
14,5 cm, 5<sup>3</sup>/<sub>4</sub>" **AK-1420-14**  
20,0 cm, 8" **AK-1420-20**



**LANE**  
14,5 cm, 5<sup>3</sup>/<sub>4</sub>" **AK-1422-14**  
20,0 cm, 8" **AK-1422-20**



**BROWN**  
15,0 cm, 6" **AK-1410-15**  
20,0 cm, 8" **AK-1410-20**  
25,0 cm, 10" **AK-1410-25**



**TREVS**  
13,0 cm, 5" **AK-1510-13**  
15,0 cm, 6" **AK-1510-15**

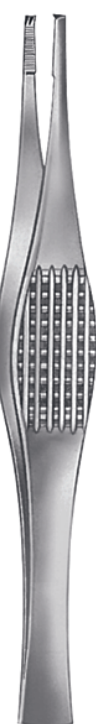

**RAMSEY**  
18,0 cm, 7"  
**AK-1520-18**



**RAMSEY**  
18,0 cm, 7"  
**AK-1522-18**



**RAMSEY**  
18,0 cm, 7"  
**AK-1590-18**



**RAMSEY**  
18,0 cm, 7"  
**AK-1592-18**

**Splitterpinzetten  
Splinter Forceps  
Pinzas para espinas  
Pinze per schegge**

**gerieft**



**gebogen  
gerieft**



**mit AKift**



**mit AKift  
gebogen  
gerieft**



8,0 cm, 3 <sup>1</sup> / <sub>4</sub> "	<b>AK-1662-08</b>
9,0 cm, 3 <sup>1</sup> / <sub>2</sub> "	<b>AK-1662-09</b>
10,5 cm, 4 <sup>1</sup> / <sub>8</sub> "	<b>AK-1662-10</b>
11,5 cm, 4 <sup>1</sup> / <sub>2</sub> "	<b>AK-1662-11</b>
13,0 cm, 5"	<b>AK-1662-13</b>
14,5 cm, 5 <sup>1</sup> / <sub>2</sub> "	<b>AK-1662-14</b>

8,0 cm, 3 <sup>1</sup> / <sub>4</sub> "	<b>AK-1663-08</b>
9,0 cm, 3 <sup>1</sup> / <sub>2</sub> "	<b>AK-1663-09</b>
10,5 cm, 4 <sup>1</sup> / <sub>8</sub> "	<b>AK-1663-10</b>
11,5 cm, 4 <sup>1</sup> / <sub>2</sub> "	<b>AK-1663-11</b>
13,0 cm, 5"	<b>AK-1663-13</b>
14,5 cm, 5 <sup>1</sup> / <sub>2</sub> "	<b>AK-1663-14</b>

8,0 cm, 3 <sup>1</sup> / <sub>4</sub> "	<b>AK-1666-08</b>
9,0 cm, 3 <sup>1</sup> / <sub>2</sub> "	<b>AK-1666-09</b>
10,5 cm, 4 <sup>1</sup> / <sub>8</sub> "	<b>AK-1666-10</b>
11,5 cm, 4 <sup>1</sup> / <sub>2</sub> "	<b>AK-1666-11</b>
13,0 cm, 5"	<b>AK-1666-13</b>
14,5 cm, 5 <sup>1</sup> / <sub>2</sub> "	<b>AK-1666-14</b>

8,0 cm, 3 <sup>1</sup> / <sub>4</sub> "	<b>016-1667-08</b>
9,0 cm, 3 <sup>1</sup> / <sub>2</sub> "	<b>016-1667-09</b>
10,5 cm, 4 <sup>1</sup> / <sub>8</sub> "	<b>016-1667-10</b>
11,5 cm, 4 <sup>1</sup> / <sub>2</sub> "	<b>016-1667-11</b>
13,0 cm, 5"	<b>016-1667-13</b>
14,5 cm, 5 <sup>1</sup> / <sub>2</sub> "	<b>016-1667-14</b>



**Splitterpinzetten, Mikro-Pinzetten**  
**Splinter Forceps, Micro Forceps**  
**Pinzas para espinas, Pinzas para microscopia**  
**Pinze per schegge, Pinze per microscopia**



**HUNTER**  
10,5 cm, 4<sup>1</sup>/<sub>4</sub>"  
**AK-1652-10**



**HUNTER**  
10,5 cm, 4<sup>1</sup>/<sub>4</sub>"  
**AK-1653-10**



**WALTER-CARMALT**  
10,5 cm, 4<sup>1</sup>/<sub>4</sub>"  
**AK-1656-10**



**WALTER-CARMALT**  
10,5 cm, 4<sup>1</sup>/<sub>4</sub>"  
**AK-1657-10**



**FEILCHENFELD**  
7,5 cm, 3<sup>1</sup>/<sub>8</sub>" **AK-1650-07**  
9,0 cm, 3<sup>1</sup>/<sub>2</sub>" **AK-1650-09**  
11,5 cm, 4<sup>1</sup>/<sub>2</sub>" **AK-1650-11**



10,0 cm, 4"  
**AK-1806-10**



10,0 cm, 4"  
**AK-1807-10**



10,0 cm, 4"  
**AK-1809-10**  
selbAKhaltend  
glatt

**Mikro-Pinzetten**  
**Micro Forceps**  
**Pinzas para microscopia**  
**Pinze per microscopia**



**GRAEFE**  
10,0 cm, 4"  
**AK-1810-10**



**GRAEFE**  
10,0 cm, 4"  
**AK-1811-10**



**GRAEFE**  
10,0 cm, 4"  
**AK-1813-10**



**GRAEFE**  
10,0 cm, 4"  
**AK-1814-10**



**GRAEFE**  
10,0 cm, 4"  
**AK-1815-10**



**GRAEFE**  
10,0 cm, 4"  
**AK-1817-10**



**Uhrmacher Pinzetten, Gefäßdilatoren**  
**Jeweller's Forceps, Vessel Dilators**  
**Pinzas de relojería, Dilatadores vasculares**  
**Pinze per orologiaio, Dilatatori vascolari**



Fig. 3  
11,5 cm, 4 1/2"  
AK-1601-03



Fig. 4  
11,5 cm, 4 1/2"  
AK-1601-04



Fig. 5  
11,5 cm, 4 1/2"  
AK-1601-05



Fig. 7  
11,5 cm, 4 1/2"  
AK-1601-07

0,3 mm x 45°



9 mm

11,0 cm, 4 3/8"  
AK-1620-01

0,3 mm x 90°



9 mm

11,0 cm, 4 3/8"  
AK-1620-02

0,3 mm



9 mm

11,0 cm, 4 3/8"  
AK-1620-03

0,3 mm x 45°



9 mm

11,0 cm, 4 3/8"  
AK-1620-04

diamantbeschichtet  
diamond coated  
diamantado  
diamantato



**Gefäßdilatoren, Atraumatische Pinzetten**  
**Vessel Dilators, Atraumatic Forceps**  
**Dilatadores vasculares, Pinzas atraumáticas**  
**Dilatatori vascolari, Pinze anatomiche atraumatica**

0,3 mm



9 mm

12,0 cm, 4<sup>3</sup>/<sub>4</sub>"  
AK-1634-12

0,3 mm



9 mm

13,5 cm, 5<sup>3</sup>/<sub>8</sub>"  
AK-1634-13

0,4 mm



9 mm

13,5 cm, 5<sup>3</sup>/<sub>8</sub>"  
AK-1635-13

0,3 mm x 45°



9 mm

13,5 cm, 5<sup>3</sup>/<sub>8</sub>"  
AK-1637-13



1,5 mm    2,0 mm    2,4 mm    2,8 mm



16,0 cm, 6<sup>1</sup>/<sub>4</sub>" **AK-1700-16** **AK-1702-16** **AK-1704-16** **AK-1706-16**  
20,0 cm, 8" **AK-1700-20** **AK-1702-20** **AK-1704-20** **AK-1706-20**  
24,0 cm, 9<sup>1</sup>/<sub>2</sub>" **AK-1700-24** **AK-1702-24** **AK-1704-24** **AK-1706-24**  
30,0 cm, 12" **AK-1700-30** **AK-1702-30** **AK-1704-30** **AK-1706-30**

2,8 mm    3,5 mm    3,5 mm



16,0 cm, 6<sup>1</sup>/<sub>4</sub>" **AK-1716-16** **AK-1708-16** **AK-1718-16**  
20,0 cm, 8" **AK-1716-20** **AK-1708-20** **AK-1718-20**  
24,0 cm, 9<sup>1</sup>/<sub>2</sub>" **AK-1716-24** **AK-1708-24** **AK-1718-24**  
30,0 cm, 12" **AK-1716-30** **AK-1708-30** **AK-1718-30**



1,5 mm    2,0 mm



16,0 cm, 6<sup>1</sup>/<sub>4</sub>" **AK-1701-16** **AK-1703-16**  
20,0 cm, 8" **AK-1701-20** **AK-1703-20**  
24,0 cm, 9<sup>1</sup>/<sub>2</sub>" **AK-1701-24** **AK-1703-24**  
30,0 cm, 12" **AK-1701-30** **AK-1703-30**

DE BAKEY

DE BAKEY



Pinzetten mit HaAKmetalleinlagen  
Forceps with tungAKen carbide inseAAK  
Pinzas con bocas de carburo tungAKeno  
Pinze con morsi in carburo di tungAKeno



AKANDARD	
14,5 cm, 5 <sup>3</sup> / <sub>4</sub> "	<b>AK-1200-14</b>
16,0 cm, 6 <sup>1</sup> / <sub>4</sub> "	<b>AK-1200-16</b>
18,0 cm, 7"	<b>AK-1200-18</b>
20,0 cm, 8"	<b>AK-1200-20</b>
25,0 cm, 10"	<b>AK-1200-25</b>
30,0 cm, 12"	<b>AK-1200-30</b>



AKANDARD	
14,0 cm, 5 <sup>1</sup> / <sub>2</sub> "	<b>AK-1208-14</b>
16,0 cm, 6 <sup>1</sup> / <sub>4</sub> "	<b>AK-1208-16</b>
18,0 cm, 7"	<b>AK-1208-18</b>
20,0 cm, 8"	<b>AK-1208-20</b>
25,0 cm, 10"	<b>AK-1208-25</b>
30,0 cm, 12"	<b>AK-1208-30</b>



AKANDARD	
12,5 cm, 5"	<b>AK-1040-12</b>
15,0 cm, 6"	<b>AK-1040-15</b>



AKANDARD	
15,0 cm, 6"	<b>AK-1140-15</b>
23,0 cm, 9"	<b>AK-1140-23</b>
25,0 cm, 10"	<b>AK-1140-25</b>

Pinzetten mit HaAKmetalleinlagen  
Forceps with tungAKen carbide inseAKK  
Pinzas con bocas de carburo tungAKeno  
Pinze con morsi in carburo di tungAKeno



**GILLIES**  
15,0 cm, 6"  
AK-1300-15



**MC INDOE**  
15,0 cm, 6"  
AK-1158-15



017-1102-17



017-1302-17



**POTTS-SMITH**  
15,0 cm, 6" **AK-1026-15**  
18,0 cm, 7" **AK-1026-18**  
20,0 cm, 8" **AK-1026-20**



**BONNEY**  
17,5 cm, 6<sup>5</sup>/<sub>8</sub>"  
AK-1590-17



**CUSHING**  
17,5 cm, 6<sup>5</sup>/<sub>8</sub>"

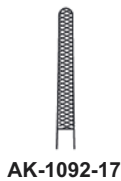

**CUSHING-TAYLOR**  
18,0 cm, 7"  
AK-1117-18



**ADSON**  
17,5 cm, 6<sup>5</sup>/<sub>8</sub>"

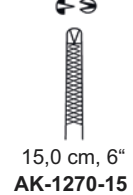
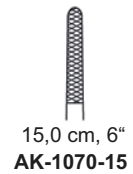
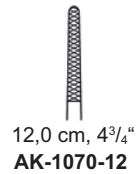



**VASE** INSTRUMENTS  
PREMIUM QUALITY INSTRUMENTS

**Tuch-, Schlauchklemmen, Tupferzangen**

**Towel Clamps, Sponge and Dressing Forceps, Tubing Clamps**

**Pinzas de campo, Pinzas para vendajes y torundas y para tubos**

**Pinze per fissare le compresse, per medicatura e tamponi, e per tubi**





**Tuchklemmen**  
**Towel Clamps**  
**Pinzas de campo**  
**Pinze per fissare le compresse**



**SCHAEDEL**  
9,0 cm, 3 1/2"  
**AK-1101-09**



**ENGL. MODELL**  
9,0 cm, 3 1/2"  
**AK-1109-09**



**JONES**  
5,0 cm, 2" **AK-1105-05**  
7,0 cm, 2 3/4" **AK-1105-07**  
9,0 cm, 3 1/2" **AK-1105-09**



**JONES**  
9,0 cm, 3 1/2"  
**AK-1107-09**

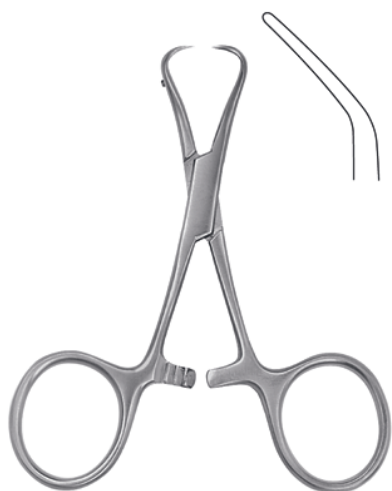

**BACKHAUS**  
9,0 cm, 3 1/2" **AK-1000-09**  
11,0 cm, 4 3/8" **AK-1000-11**  
13,0 cm, 5" **AK-1000-13**  
15,0 cm, 6" **AK-1000-15**



11,0 cm, 4 3/8"  
**AK-1005-11**

mit Schlauch- oder Kabelhalter  
with clip for tubing or cable  
con poAKa-tubo o poAKa-cable  
con poAKa-tubo o poAKa-cavo



**ROEDER**  
13,0 cm, 5"  
**AK-1010-13**

Tuchklemmen  
Towel Clamps  
Pinzas de campo  
Pinze per fissare le compresse



**ROEDER**  
15,0 cm, 5"  
AK-1010-15



**BERAKARD**  
16,5 cm, 6 1/2"  
AK-1044-16



Kugel / Pfanne  
Ball / Socket  
Bola / Cojinete  
Palla / Cuscinetto

13,0 cm, 5"  
AK-1024-13

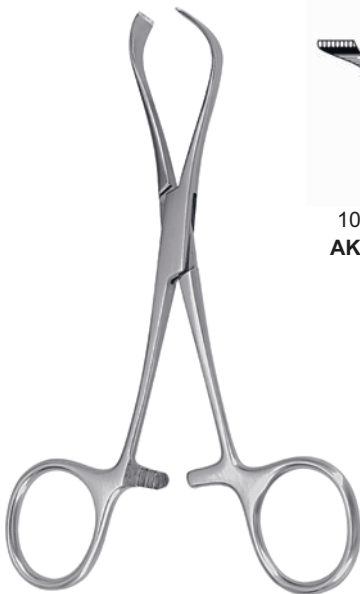

**LOAKA**



10,0 cm, 4" AK-1014-10  
13,0 cm, 5" AK-1014-13



**LANE**  
15,0 cm, 6" AK-1040-15  
18,0 cm, 7" AK-1040-18  
20,0 cm, 8" AK-1040-20



Tuchklemmen, KoAK- und Tupferzangen  
Towel Clamps, Sponge and Dressing Forceps  
Pinzas de campo, Pinzas para vendajes y torundas  
Pinze per fissare le compresse, Pinze per medicatura e tamponi



**TOHOKU**



10,0 cm, 4" **AK-1020-10**  
13,0 cm, 5" **AK-1020-13**



**PEERS**  
14,5 cm, 5 3/4"  
**AK-**



**LIAKER**  
13,0 cm, 5" **AK-1360-13**  
16,0 cm, 6 1/4" **AK-1360-16**  
18,0 cm, 7" **AK-1360-18**



**BRYANT**  
13,0 cm, 5"  
**AK-1351-13**



**BOZEMANN**  
26,0 cm, 10 1/4"  
**AK-1320-26**



**KoAK- und Tupferzangen**  
**Sponge and Dressing Forceps**  
**Pinzas para vendajes y torundas**  
**Pinze per medicatura e tamponi**

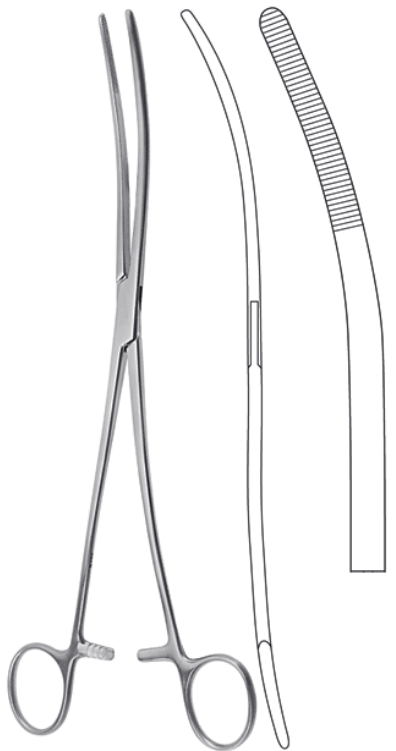

**BOZEMANN**  
26,0 cm, 10<sup>1</sup>/<sub>4</sub>"  
**AK-1321-26**



**COLLIN**  
25,0 cm, 9<sup>3</sup>/<sub>4</sub>"  
**AK-1300-25**



**CHERON**  
25,0 cm, 9<sup>3</sup>/<sub>4</sub>"  
**AK-1303-25**



**PERLMANN**  
25,0 cm, 9<sup>3</sup>/<sub>4</sub>"

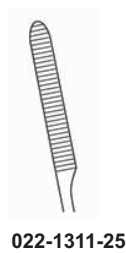

**022-1311-25**



**ULRICH**

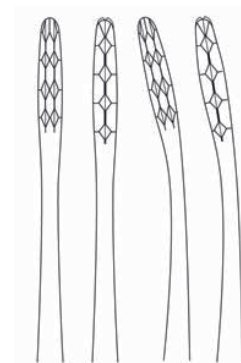

22,0 cm, 8 <sup>5</sup> / <sub>8</sub> "	<b>AK-1200-22</b>	<b>AK-1201-22</b>
25,0 cm, 9 <sup>3</sup> / <sub>4</sub> "	<b>AK-1200-22</b>	<b>AK-1201-25</b>
27,0 cm, 10 <sup>5</sup> / <sub>8</sub> "	<b>AK-1200-22</b>	<b>AK-1201-27</b>





**KoAK- und Tupferzangen**  
**Sponge and Dressing Forceps**  
**Pinzas para vendajes y torundas**  
**Pinze per medicatura e tamponi**



**GROSS-MAIER**

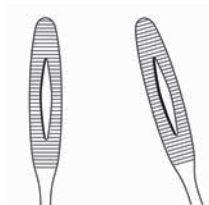

20,0 cm, 8"	<b>AK-1210-20</b>	<b>AK-1211-20</b>
22,0 cm, 8 <sup>5</sup> / <sub>8</sub> "	<b>AK-1210-22</b>	<b>AK-1211-22</b>
25,0 cm, 9 <sup>3</sup> / <sub>4</sub> "	<b>AK-1210-25</b>	<b>AK-1211-25</b>
27,0 cm, 10 <sup>5</sup> / <sub>8</sub> "	<b>AK-1210-27</b>	<b>AK-1211-27</b>



**FOERAKER**

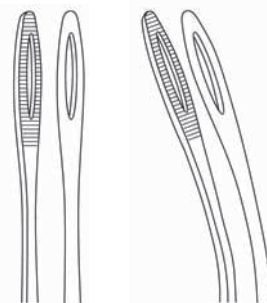

25,0 cm, 9 <sup>3</sup> / <sub>4</sub> "	<b>AK-1180-25</b>
25,0 cm, 9 <sup>3</sup> / <sub>4</sub> "	<b>AK-1181-25</b>



**FOERAKER-BALLEGER**

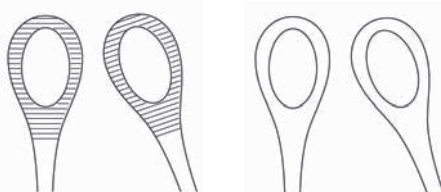

18,0 cm, 7"	<b>AK -1160-18</b>	<b>AK -1161-18</b>	<b>AK-1170-18</b>	<b>AK-1171-18</b>
20,0 cm, 8"	<b>AK-1160-20</b>	<b>AK -1161-20</b>	<b>AK-1170-20</b>	<b>AK -1171-20</b>
25,0 cm, 9 <sup>3</sup> / <sub>4</sub> "	<b>AK-1160-25</b>	<b>AK-1161-25</b>	<b>AK-1170-25</b>	<b>AK-1171-25</b>



**RAMPLEY**

18,0 cm, 7"	<b>AK-1190-18</b>
25,0 cm, 9 <sup>3</sup> / <sub>4</sub> "	<b>AK-1190-25</b>



Schlauchklemmen  
Tubing Clamps  
Pinzas para tubos  
Pinze per tubi



**PRESBYTERIAN**

16,5 cm, 6 <sup>1</sup> / <sub>2</sub> "	<b>AK-1012-16</b>
18,0 cm, 7"	<b>AK-1012-18</b>
20,0 cm, 8"	<b>AK-1012-20</b>

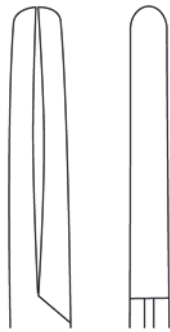

**BERLIN**  
14,5 cm, 5<sup>3</sup>/<sub>4</sub>"  
**AK-1006-14**



15,0 cm, 6"	18,0 cm, 7"	20,0 cm, 8"
<b>AK-1002-15</b>	<b>AK-1002-18</b>	<b>AK-1002-20</b>

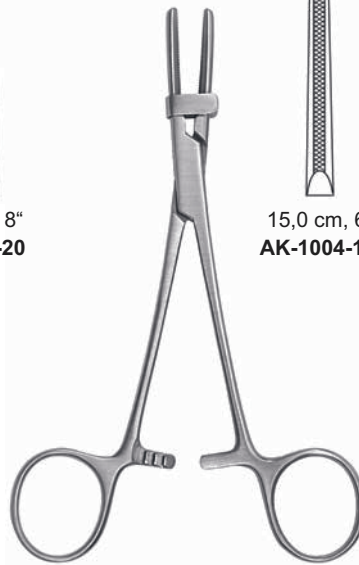
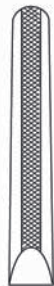

15,0 cm, 6"	18,0 cm, 7"	20,0 cm, 8"
<b>AK-1004-15</b>	<b>AK-1004-18</b>	<b>AK-1004-20</b>



MIT BÜGEL



**VASE** INSTRUMENTS  
PREMIUM QUALITY INSTRUMENTS

**Klemmen**

**Forceps**

**Pinas**

**Pinze**





**Bulldogklemmen  
Bulldog Clamps  
Clamps Bulldog  
Pinze Bulldog**



3,5 cm, 1 1/2" **AK-1014-03 AK-1015-03**  
5,0 cm, 2" **AK-1014-05 AK-1015-05**



**DIEFFENBACH**

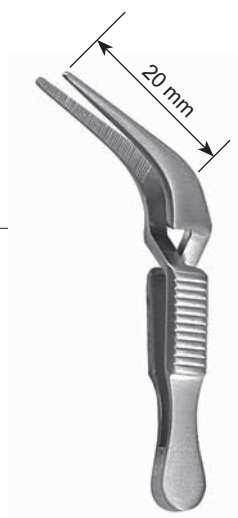

**HESS  
AK-1520-01**



**HESS  
AK-1520-02**



3,8 cm, 1 1/2" **AK-1018-04 AK-1019-04**  
5,0 cm, 2" **AK-1018-05 AK-1019-05**  
6,3 cm, 2 1/2" **AK-1018-06 AK-1019-06**  
7,6 cm, 3" **AK-1018-07 AK-1019-07**  
9,0 cm, 3 1/2" **AK-1018-09 AK-1019-09**

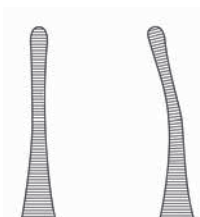

**JOHNS-HOPKINS**



**JOHNS-HOPKINS  
23,0 cm, 9"  
AK-1295-23**

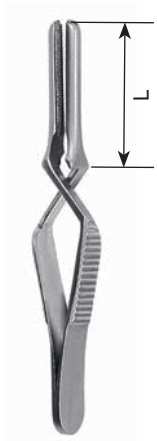

mit atraumatischer Riefung  
with non-traumatic serration  
con bocas atraumáticas  
con presa atraumatica

		L
7,5 cm, 3"	<b>AK-1292-07</b>	2,5 cm, 1"
8,5 cm, 3 <sup>1</sup> / <sub>4</sub> "	<b>AK-1292-08</b>	3,5 cm, 1 <sup>3</sup> / <sub>8</sub> "
10,5 cm, 4 <sup>1</sup> / <sub>8</sub> "	<b>AK-1292-10</b>	5,0 cm, 2"
12,0 cm, 4 <sup>3</sup> / <sub>4</sub> "	<b>AK-1292-12</b>	6,8 cm, 2 <sup>3</sup> / <sub>4</sub> "

**DE BAKEY**

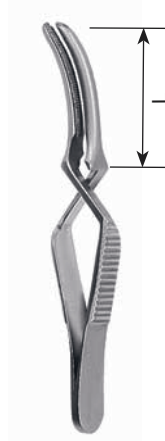

mit atraumatischer Riefung  
with non-traumatic serration  
con bocas atraumáticas  
con presa atraumatica

		L
7,0 cm, 2 <sup>3</sup> / <sub>4</sub> "	<b>AK-1293-07</b>	2,5 cm, 1"
8,0 cm, 3 <sup>1</sup> / <sub>8</sub> "	<b>AK-1293-08</b>	3,5 cm, 1 <sup>3</sup> / <sub>8</sub> "
10,0 cm, 3 <sup>3</sup> / <sub>4</sub> "	<b>AK-1293-10</b>	5,0 cm, 2"
11,5 cm, 4 <sup>1</sup> / <sub>2</sub> "	<b>AK-1293-12</b>	6,8 cm, 2 <sup>3</sup> / <sub>4</sub> "

**DE BAKEY**



**TITANIUM**  
3,5 cm, 1<sup>3</sup>/<sub>8</sub>"  
vena **AK-1032-35**  
aAKeria **AK-1042-35**



**TITANIUM**  
3,5 cm, 1<sup>3</sup>/<sub>8</sub>"  
vena **AK-1033-35**  
aAKeria **AK-1043-35**



**TITANIUM**  
4,0 cm, 1<sup>5</sup>/<sub>8</sub>"  
vena **AK-1032-40**  
aAKeria **AK-1042-40**



**TITANIUM**  
4,0 cm, 1<sup>5</sup>/<sub>8</sub>"  
vena **AK-1033-40**  
aAKeria **AK-1043-40**



**Bulldogklemmen, Darm- und Gewebefaßzangen**  
**Bulldog Clamps, InteAKinal and Tissue Grasping Forceps**  
**Clamps Bulldog, Pinzas inteAKinales y para tejidos**  
**Pinze Bulldog, Pinze da presa per inteAKino e tessuti**

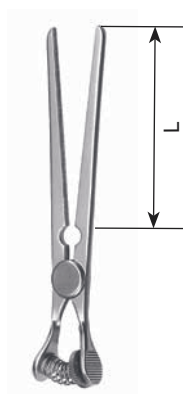

		L	
6,8 cm, 2 <sup>3</sup> / <sub>4</sub> "	<b>AK-1298-07</b>	3,3 cm, 1 <sup>3</sup> / <sub>8</sub> "	
9,6 cm, 3 <sup>3</sup> / <sub>4</sub> "	<b>AK-1298-09</b>	5,0 cm, 2"	
11,7 cm, 4 <sup>3</sup> / <sub>4</sub> "	<b>AK-1298-11</b>	6,9 cm, 2 <sup>3</sup> / <sub>4</sub> "	

**GLOVER**

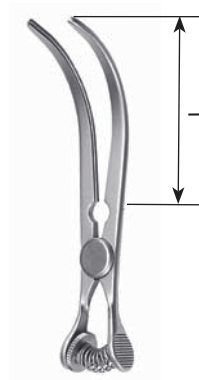

		L	
6,5 cm, 2 <sup>1</sup> / <sub>2</sub> "	<b>AK-1299-06</b>	3,3 cm, 1 <sup>3</sup> / <sub>8</sub> "	
9,1 cm, 3 <sup>1</sup> / <sub>2</sub> "	<b>AK-1299-09</b>	5,0 cm, 2"	
11,0 cm, 4 <sup>3</sup> / <sub>8</sub> "	<b>AK-1299-11</b>	6,9 cm, 2 <sup>3</sup> / <sub>4</sub> "	

**GLOVER**



**CHAPUT**  
13,0 cm, 5"  
**AK-1370-13**



**TUFFIER**  
13,0 cm, 5"  
**AK-1372-13**



**COLLIN**  
16,0 cm, 6<sup>1</sup>/<sub>4</sub>"  
**AK-1376-16**



Darm- und Gewebefäßzangen  
InteAKinal and Tissue Grasping Forceps  
Pinzas inteAKinales y para tejidos  
Pinze da presa per inteAKino e tessuti



**PENNINGTON**

15,5 cm, 6" **AK-1358-15**  
20,0 cm, 8" **AK-1358-20**



**ATRAUMA**

25,0 cm, 9<sup>3</sup>/<sub>4</sub>"  
**AK-1658-25**



27,0 cm, 10<sup>1</sup>/<sub>2</sub>"  
**AK-1658-27**



**MAAKEL**  
14,0 cm, 5<sup>1</sup>/<sub>2</sub>"  
**AK-1364-14**

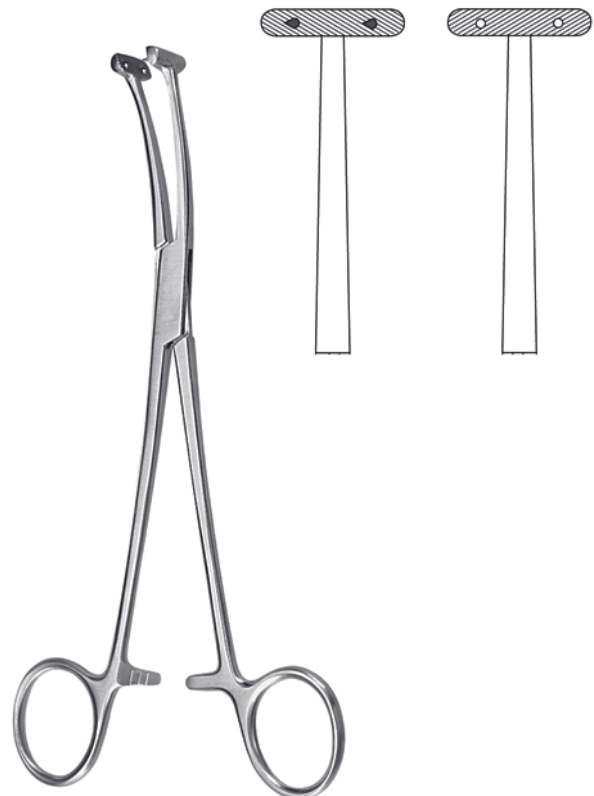

**WILLET-MAAKEL**  
19,0 cm, 7<sup>1</sup>/<sub>2</sub>"  
**AK-1366-19**



**AAKerienklemmen  
HaemoAKatic Forceps  
Pinzas hemoAKáticas  
Pinzi**



**PRATT**  
15,0 cm, 6"  
AK-1656-15



**FERGUSSON**

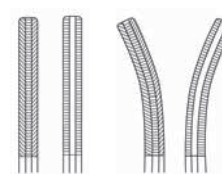

16,0 cm, 6<sup>1</sup>/<sub>4</sub>" **AK-650-16** **AK-651-16**  
20,0 cm, 8" **AK-650-20** **AK-651-20**



**CARREL**  
10,0 cm, 4"  
AK-1010-10



**TERRIER**  
10,0 cm, 4"  
AK-1016-10



**KROENLEIN**  
13,0 cm, 5"  
AK-1369-13





**AAKerienklemmen**  
**HaemoAKatic Forceps**  
**Pinzas hemoAKáticas**  
**Pinze emoAKatiche**



**PEAN**

14,0 cm, 5½" **AK-1368-14**  
16,0 cm, 6¼" **AK-1368-16**



**BABY-MIXTER**

14,0 cm, 5½"

**AK-1475-01**

**AK-1475-02**



**SPENCER-WELLS**

13,0 cm, 5"	<b>AK-1290-13 AK-1291-13</b>
15,0 cm, 6"	<b>AK-1290-15 AK-1291-15</b>
18,0 cm, 7"	<b>AK-1290-18 AK-1291-18</b>
20,0 cm, 8"	<b>AK-1290-20 AK-1291-20</b>



**HAAKMANN**

10,0 cm, 4"

**AK-1000-10**

**AK-1001-10**



**AAKerienklemmen**  
**HaemoAKatic Forceps**  
**Pinzas hemoAKáticas**  
**Pinze emoAKatiche**

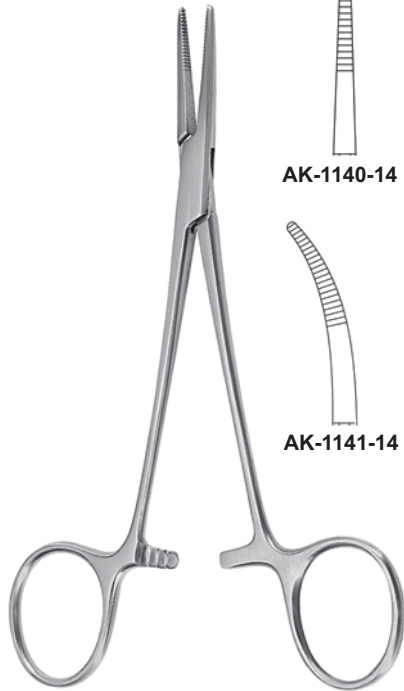

**PROVICENCE-HOSPITAL**  
14,0 cm, 5 1/2"



**AK-1140-14**



**AK-1141-14**



**HALAKED-MOSQUITO**



12,5 cm, 5"

**AK-1050-12 AK-1051-12**

25,0 cm, 9 3/4"

**AK-1050-14 AK-1051-14**

1 x 2



12,5 cm, 5"

**AK-1070-12 AK-1071-12**

25,0 cm, 9 3/4"

**AK-1070-14 AK-1071-14**

1 x 2



**HALAKED-MOSQUITO**



18,0 cm, 7"  
**AK-1050-18**



18,0 cm, 7"  
**AK-1051-18**



21,0 cm, 8 1/4"  
**AK-1050-21**



21,0 cm, 8 1/4"  
**AK-1051-21**

1 x 2



18,0 cm, 7"  
**AK-1070-18**

1 x 2



18,0 cm, 7"  
**AK-1071-18**

1 x 2



21,0 cm, 8 1/4"  
**AK-1070-21**

1 x 2

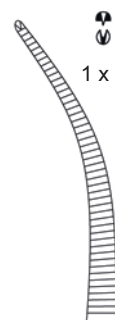

21,0 cm, 8 1/4"  
**AK-1071-21**

AAKerienklemmen  
HaemoAKatic Forceps  
Pinzas hemoAKáticas  
Pinze emoAKatiche



**MICRO-MOSQUITO**

10,0 cm, 4" **AK-1020-10 AK-1021-10 AK-1030-10 AK-1031-10**  
12,0 cm, 4<sup>3</sup>/<sub>4</sub>" **AK-1020-12 AK-1021-12 AK-1030-12 AK-1031-12**

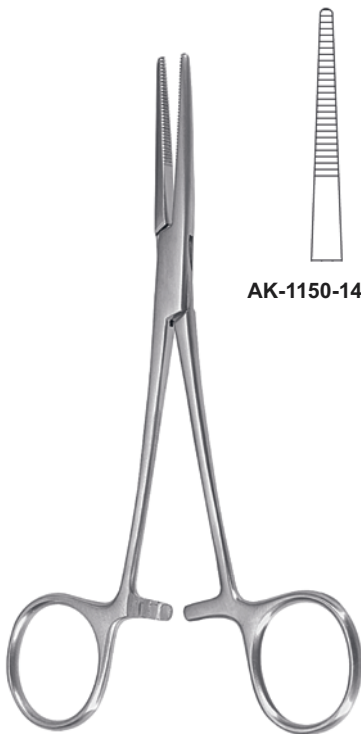
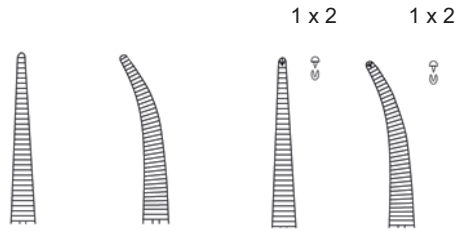

**KELLY**  
14,0 cm, 5<sup>1</sup>/<sub>2</sub>"

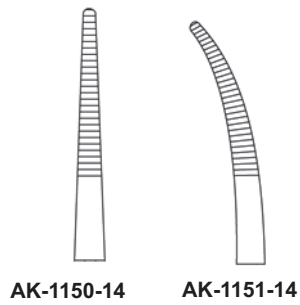

**KELLY-RANKIN**  
16,0 cm, 6<sup>1</sup>/<sub>4</sub>"

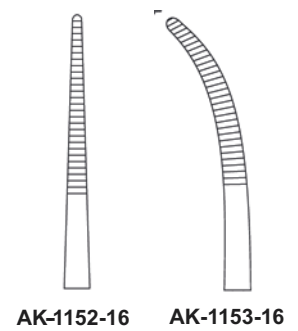



**AAKerienklemmen  
HaemoAKatic Forceps  
Pinzas hemoAKáticas  
Pinze emoAKatiche**



**LERICHE**  
15,0 cm, 6"



**AK-1380-15**



**AK-1381-15**

1 x 2



**AK-1382-15**

1 x 2



**AK-1383-15**



**BABY-OVERHOLT**  
13,5 cm, 5 1/4"  
**AK-1424-14**



**DANDY**  
14,0 cm, 5 1/2"

1 x 2



**AK-1347-14**



**CRILE**  
14,0 cm, 5 1/2"



**AK-1160-14**



**AK-1161-14**

1 x 2



**AK-1170-14**

1 x 2



**AK-1171-14**



AAKerienklemmen  
HaemoAKatic Forceps  
Pinzas hemoAKáticas  
Pinze emoAKatiche



**DIXON-LOVELACE**  
15,0 cm, 6"

AK-1354-15

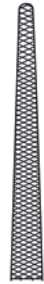

AK-1356-15

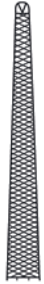

1 x 2

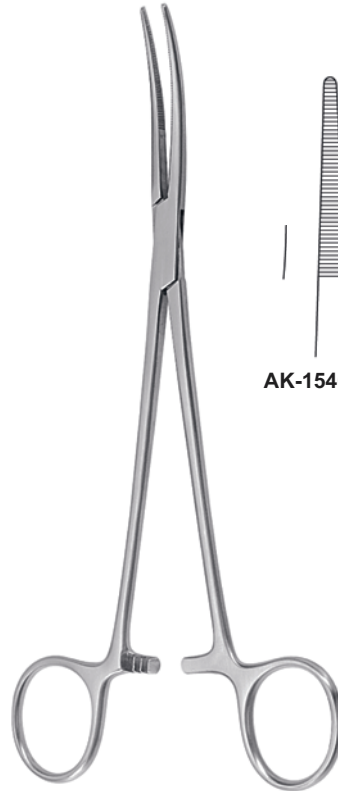

**BIRKETT**  
19,0 cm, 7 1/2"

AK-1540-19



AK-1541-19



**CRILE-RANKIN**  
16,0 cm, 6 1/4"

AK-1180-16



AK-1181-16



1 x 2



AK-1182-16



1 x 2



AK-1183-16





**AAKerienklemmen**  
**HaemoAKatic Forceps**  
**Pinzas hemoAKáticas**  
**Pinze emoAKatische**

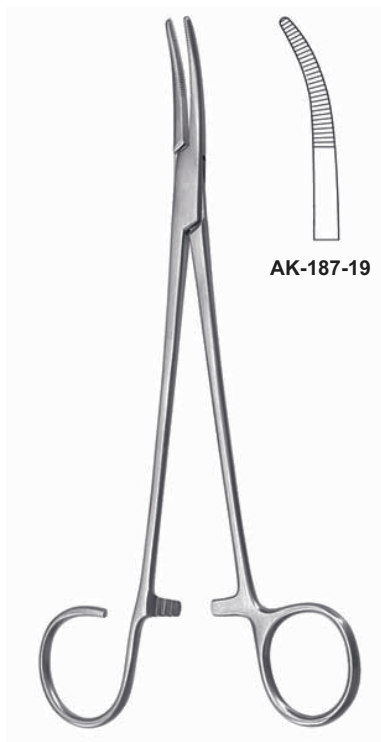

AK-187-19

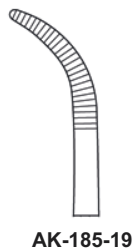

AK-185-19



AK-183-19

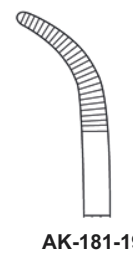

AK-181-19

**SCHNIDT**  
19,0 cm, 7 1/2"

**SCHNIDT-SAWTELL**  
19,0 cm, 7 1/2"



**ADSON**  
18,5 cm, 7 1/4"



AK-180-16

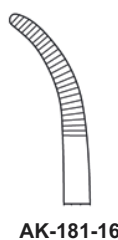

AK-181-16



AK-182-16

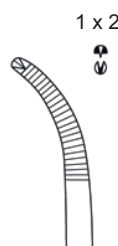

AK-183-16

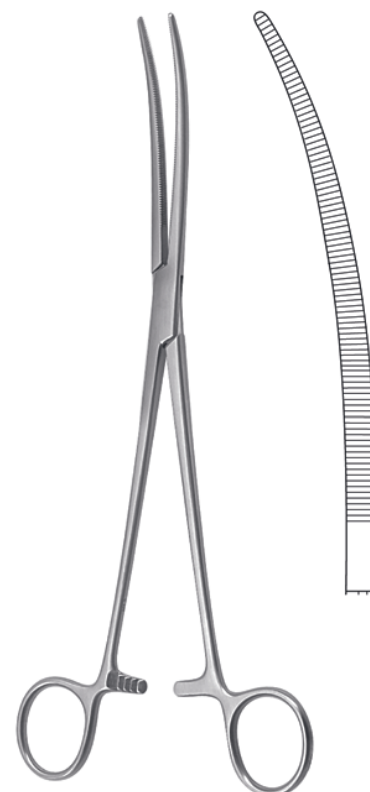

**CRAFOORD**  
24,0 cm, 9 1/2"  
AK-453-24



**AAKerienklemmen**  
**HaemoAKatic Forceps**  
**Pinzas hemoAKáticas**  
**Pinze emoAKatiche**



15,0 cm, 6" **AK-1480-15 AK-1481-15**  
18,5 cm, 7 1/4" **AK-1480-18 AK-1481-18**

**BAINBRIDGE**



16,0 cm, 6 1/4" **AK-1340-16 AK-1341-16**  
20,0 cm, 8" **AK-1340-20 AK-1341-20**

**ROCHEAKER-CARMALT**



13,0 cm, 5" **AK-1262-13 AK-1263-13**  
14,0 cm, 5 1/2" **AK-1262-14 AK-1263-14**  
16,0 cm, 6 1/4" **AK-1262-16 AK-1263-16**

**PEAN DELICATE**



13,0 cm, 5" **AK-1352-13 AK-1353-13**  
14,0 cm, 5 1/2" **AK-1352-14 AK-1353-14**  
16,0 cm, 6 1/4" **AK-1352-16 AK-1353-16**

**KOCHER DELICATE**



**AAKerienklemmen**  
**HaemoAKatic Forceps**  
**Pinzas hemoAKáticas**  
**Pinze emoAKatiche**

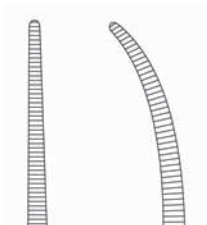

14,0 cm, 5 1/2"	<b>AK-1260-14</b>	<b>AK--1261-14</b>
16,0 cm, 6 1/4"	<b>AK-1260-16</b>	<b>AK--1261-16</b>
18,0 cm, 7"	<b>AK-1260-18</b>	<b>AK--1261-18</b>
20,0 cm, 8"	<b>AK-1260-20</b>	<b>AK--1261-20</b>
22,0 cm, 8 5/8"	<b>AK-1260-22</b>	<b>AK--1261-22</b>
24,0 cm, 9 1/2"	<b>AK-1260-24</b>	<b>AK--1261-24</b>
26,0 cm, 10 1/4"	<b>AK-1260-26</b>	<b>AK--1261-26</b>
30,0 cm, 12"	<b>AK-1260-30</b>	<b>AK-1261-30</b>

**ROCHEAKER-PEAN**

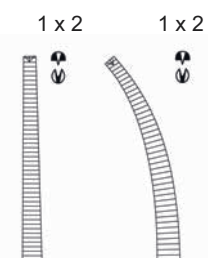
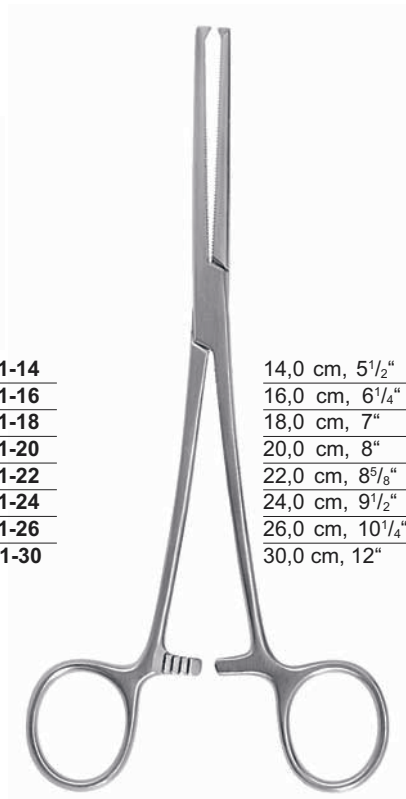

14,0 cm, 5 1/2"	<b>AK-1350-14</b>	<b>AK--1351-14</b>
16,0 cm, 6 1/4"	<b>AK-1350-16</b>	<b>AK--1351-16</b>
18,0 cm, 7"	<b>AK-1350-18</b>	<b>AK--1351-18</b>
20,0 cm, 8"	<b>AK-1350-20</b>	<b>AK--1351-20</b>
22,0 cm, 8 5/8"	<b>AK-1350-22</b>	<b>AK--1351-22</b>
24,0 cm, 9 1/2"	<b>AK-1350-24</b>	<b>AK--1351-24</b>
26,0 cm, 10 1/4"	<b>AK-1350-26</b>	<b>AK--1351-26</b>
30,0 cm, 12"	<b>AK-1350-30</b>	<b>AK-1351-30</b>

**KOCHER-OCHSNER**

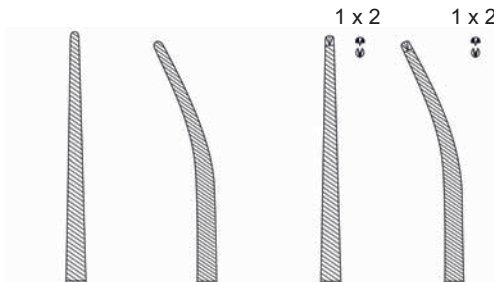

20,0 cm, 8"	<b>AK-1384-20</b>	<b>AK-1385-20</b>	<b>AK-1386-20</b>	<b>AK-1387-20</b>
26,0 cm, 10 1/4"	<b>AK-1384-26</b>	<b>AK-1385-26</b>	<b>AK-1386-26</b>	<b>AK-1387-26</b>

**BENGOLEA**





**AAKerienklemmen**  
**HaemoAKatic Forceps**  
**Pinzas hemoAKáticas**  
**Pinze emoAKatiche**



AK-1390-20 AK-1391-20 AK-1393-20

**HEISS**  
20,0 cm, 8"



AK-1448-22 AK-1449-22

**ROBEAAK**  
22,0 cm, 8<sup>5</sup>/<sub>8</sub>"



AK-1450-24 AK-1451-24

**SAROT**  
24,0 cm, 9<sup>1</sup>/<sub>2</sub>"



AK-1533-01 AK-1533-02

**NEGUS**  
19,0 cm, 7<sup>1</sup>/<sub>2</sub>"



Präparier- und Ligaturklemmen  
DisseAKing and Ligature Forceps  
Pinzas de disección y ligaduras  
Pinze per preparazioni e legature



14,0 cm, 5 1/2" **AK-1411-14**  
18,0 cm, 7" **AK-1411-18**

**BABY-ADSON**



**MICRO-ADSON**  
14,0 cm, 5 1/2"  
**AK-1409-14**



**BABY-MIXTER**  
18,0 cm, 7"  
**AK-1475-18**



**OVERHOLT-MIXTER**  
21,0 cm, 8 1/4"  
**AK-1471-21**



**JOHNS HOPKINS**  
20,0 cm, 8"  
**AK-1497-20**



Präparier- und Ligaturklemmen  
Dissecting and Ligature Forceps  
Pinzas de disección y ligaduras  
Pinze per preparazioni e legature



**OVERHOLT**

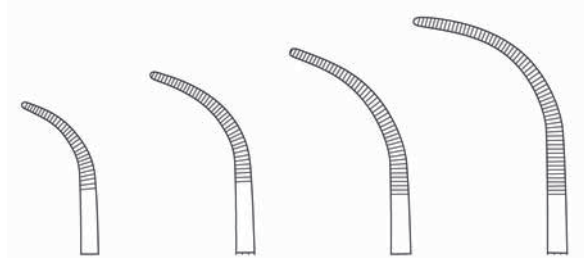

18,5 cm, 7 1/4"  
AK-1423-01

20,0 cm, 8"  
AK-1423-02

21,0 cm, 8 1/4"  
AK-1423-03

21,5 cm, 8 1/2"  
AK-1423-04



**RUMEL**  
23,0 cm, 9"

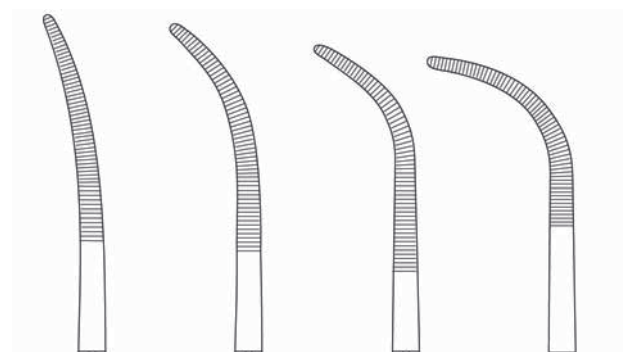

AK-1441-01

AK-1441-02

AK-1441-03

AK-1441-04



Präparier- und Ligaturklemmen  
DisseAKing and Ligature Forceps  
Pinzas de disección y ligaduras  
Pinze per preparazioni e legature



OVERHOLT-GEISSENDOERFER

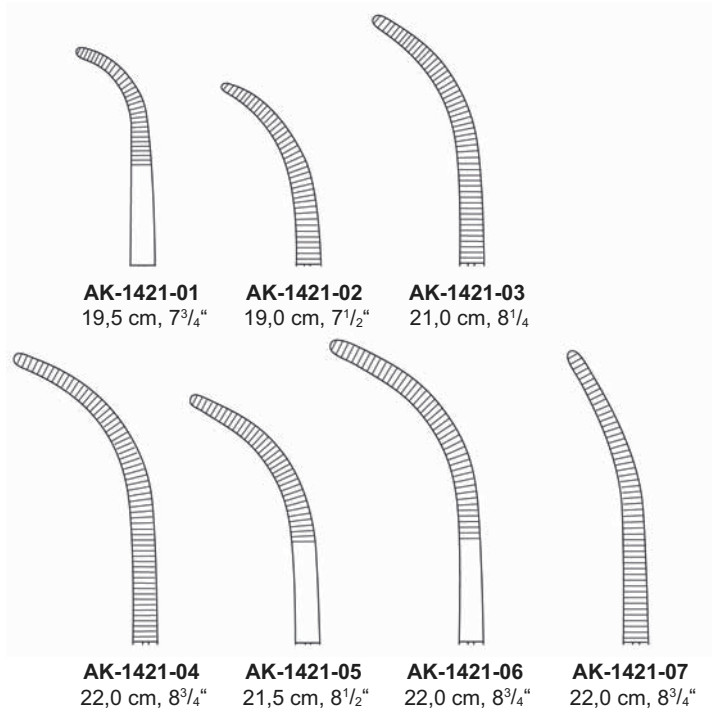

OVERHOLT-GEISSENDOERFER

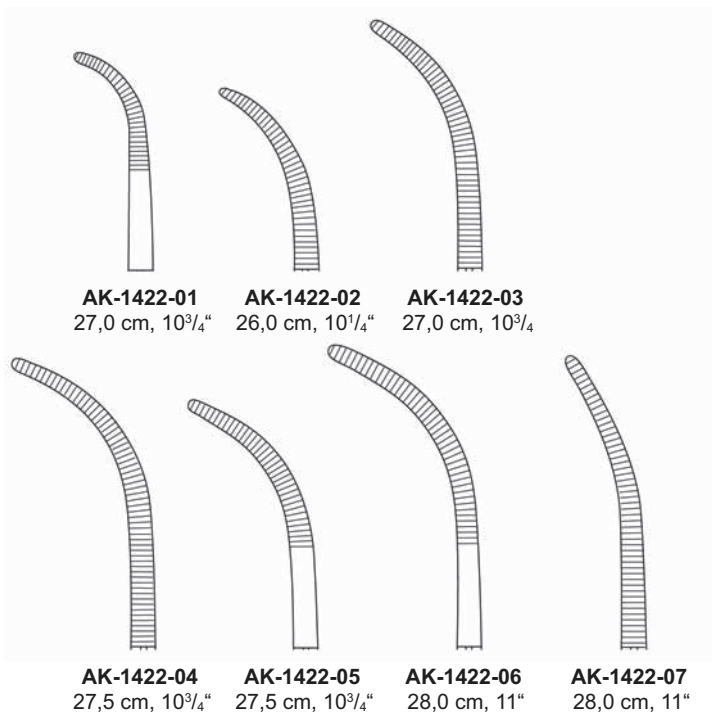



Präparier- und Ligaturklemmen  
DisseAKing and Ligature Forceps  
Pinzas de disección y ligaduras  
Pinze per preparazioni e legature

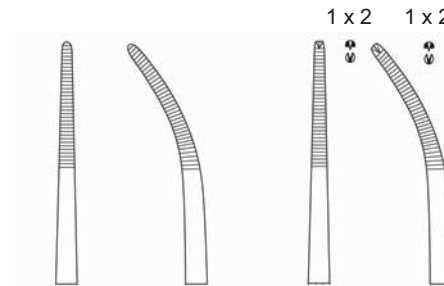
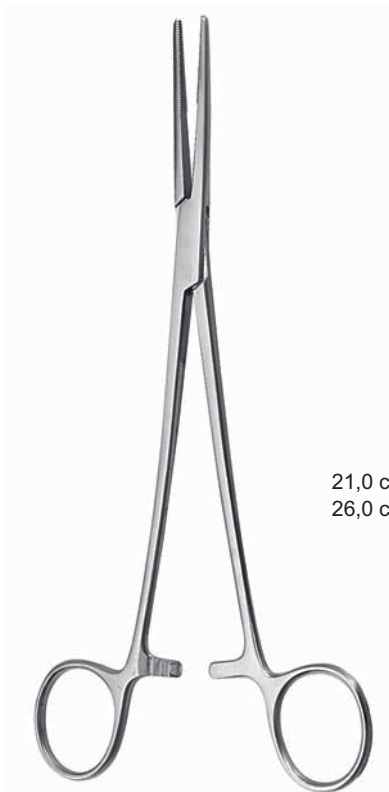

21,0 cm, 8<sup>1</sup>/<sub>4</sub>" **AK-1442-21 AK-1443-21 AK-1444-21 AK-1445-21**  
26,0 cm, 10<sup>1</sup>/<sub>4</sub>" **AK-1442-26 AK-1443-26 AK-1444-26 AK-1445-26**

**TOENNIS**

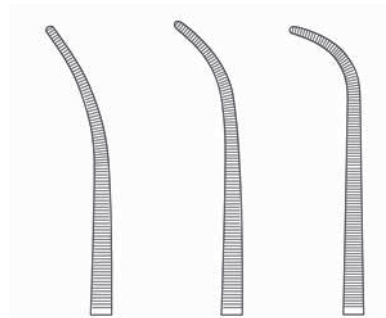

19,0 cm, 7<sup>1</sup>/<sub>2</sub>" **AK-1463-19 AK--1465-19 AK-1467-19**  
22,0 cm, 8<sup>5</sup>/<sub>8</sub>" **AK-1463-22 AK--1465-22 AK-1467-22**  
24,0 cm, 9<sup>1</sup>/<sub>2</sub>" **AK-1463-24 AK-1465-24 AK-1467-24**

**KELLY**



**Präparier- und Ligaturklemmen**  
**DisseAKing and Ligature Forceps**  
**Pinzas de disección y ligaduras**  
**Pinze per preparazioni e legature**

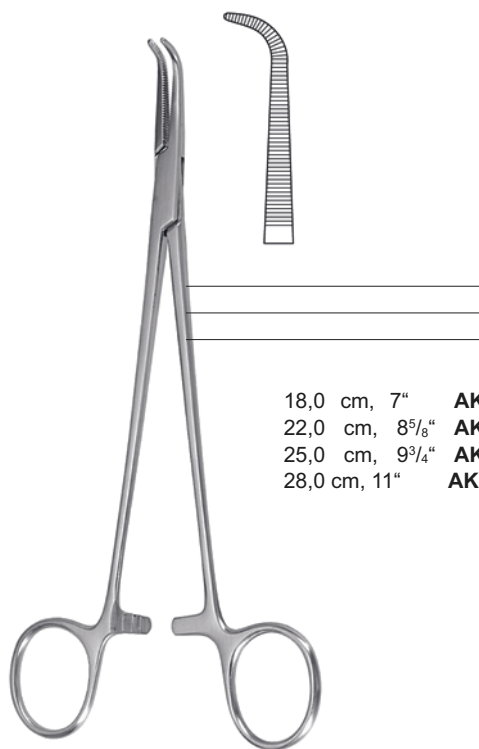

- 18,0 cm, 7" **AK-1429-18**
- 22,0 cm, 8<sup>5</sup>/<sub>8</sub>" **AK-1429-22**
- 25,0 cm, 9<sup>3</sup>/<sub>4</sub>" **AK-1429-25**
- 28,0 cm, 11" **AK-1429-28**

**MINI-GEMINI**

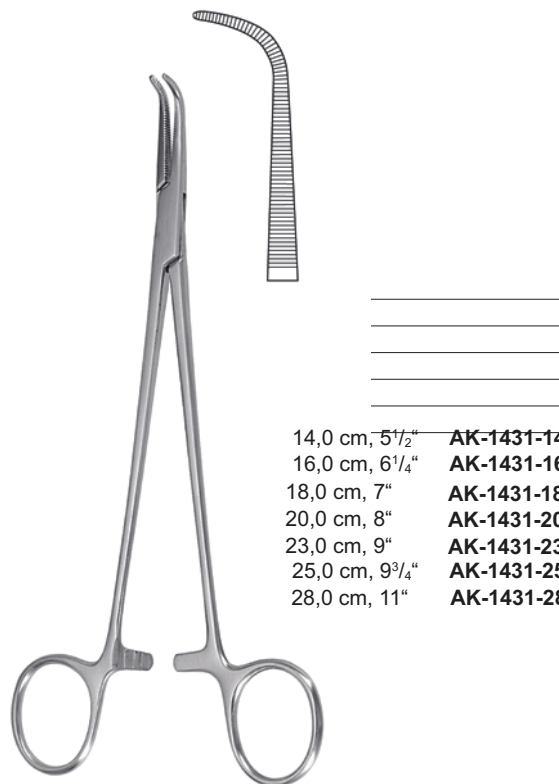

- 14,0 cm, 5<sup>1</sup>/<sub>2</sub>" **AK-1431-14**
- 16,0 cm, 6<sup>1</sup>/<sub>4</sub>" **AK-1431-16**
- 18,0 cm, 7" **AK-1431-18**
- 20,0 cm, 8" **AK-1431-20**
- 23,0 cm, 9" **AK-1431-23**
- 25,0 cm, 9<sup>3</sup>/<sub>4</sub>" **AK-1431-25**
- 28,0 cm, 11" **AK-1431-28**

**GEMINI**

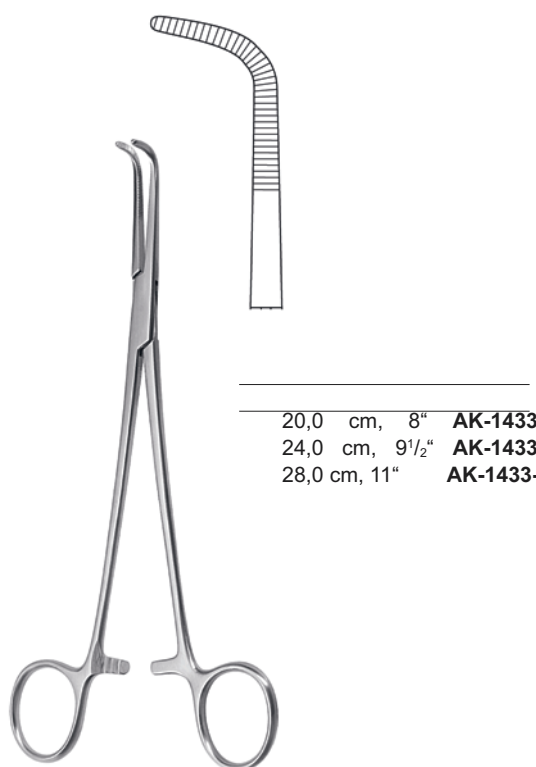

- 20,0 cm, 8" **AK-1433-20**
- 24,0 cm, 9<sup>1</sup>/<sub>2</sub>" **AK-1433-24**
- 28,0 cm, 11" **AK-1433-28**

**KANTROWITZ**

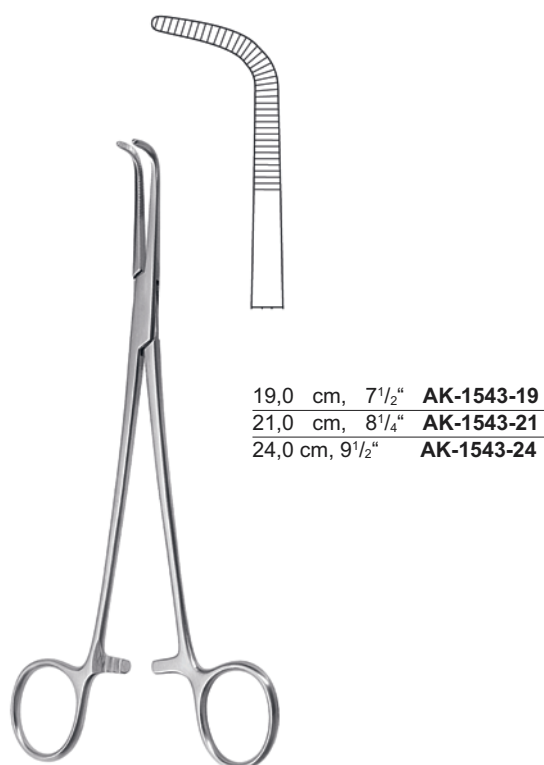

- 19,0 cm, 7<sup>1</sup>/<sub>2</sub>" **AK-1543-19**
- 21,0 cm, 8<sup>1</sup>/<sub>4</sub>" **AK-1543-21**
- 24,0 cm, 9<sup>1</sup>/<sub>2</sub>" **AK-1543-24**

**WIKAKROEM**



Präparier- und Ligaturklemmen  
DisseAKing and Ligature Forceps  
Pinzas de disección y ligaduras  
Pinze per preparazioni e legature



**MIXTER**  
15,5 cm, 6" **AK-1461-15**  
19,0 cm, 7½" **AK-1461-19**



**MIXTER-O'SHAUGNESSY**  
15,5 cm, 6" **AK-1477-15**  
19,0 cm, 7½" **AK-1477-19**



**MIXTER**  
22,0 cm, 8¾" **AK-1473-22**



**MIXTER**  
23,0 cm, 9" **AK-1473-23**

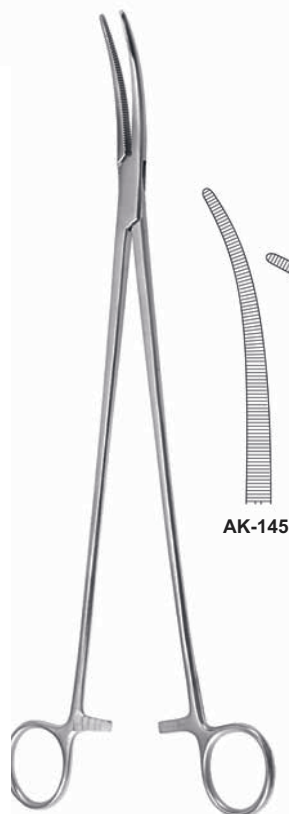

**ZENKER**

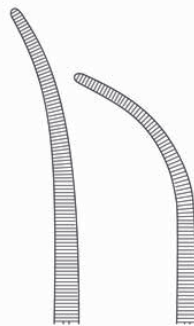

**AK-1455-01 AK-1455-02**

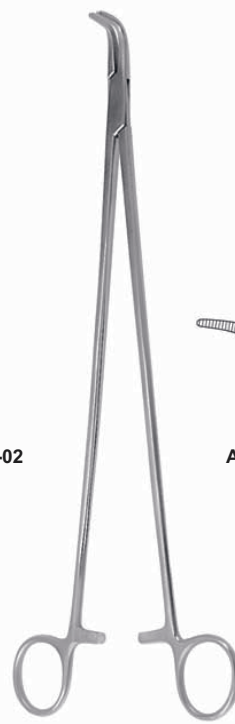

**ZENKER**

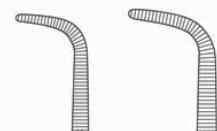

**AK-1459-18 AK-1459-28**



**Präparier- und Ligaturklemmen**  
**DisseAKing and Ligature Forceps**  
**Pinzas de disección y ligaduras**  
**Pinze per preparazioni e legature**



**LAWRENCE**  
27,5 cm, 10<sup>3</sup>/<sub>4</sub>"  
**AK-1457-28**

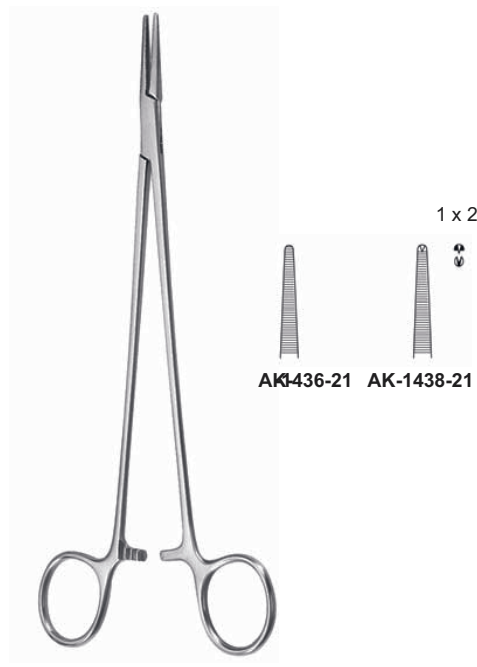

**HOSEMANN**  
21,0 cm, 8<sup>1</sup>/<sub>4</sub>"



**DESJARDINS**  
21,0 cm, 8<sup>1</sup>/<sub>4</sub>"  
**AK-1529-21**

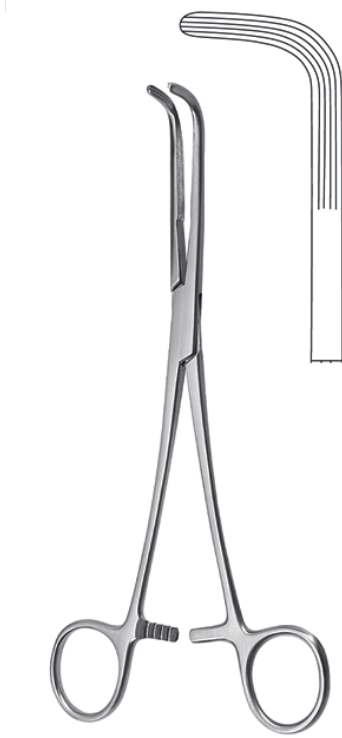

**MIXTER**  
22,0 cm, 8<sup>3</sup>/<sub>4</sub>" **AK-1479-22**  
25,0 cm, 9<sup>3</sup>/<sub>4</sub>" **AK-1479-25**  
28,0 cm, 11" **AK-1479-28**

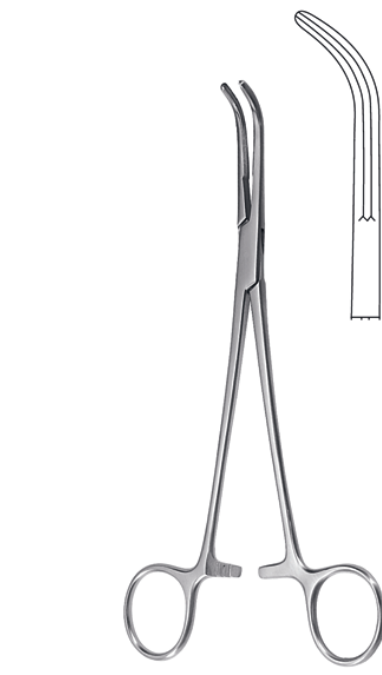

**LAHEY**  
19,0 cm, 7<sup>1</sup>/<sub>2</sub>" **AK-1501-19**  
23,0 cm, 9" **AK-1501-23**



**LOWER**  
18,0 cm, 7"  
**AK-1503-18**



Präparier- und Ligaturklemmen  
DisseAKing and Ligature Forceps  
Pinzas de disección y ligaduras  
Pinze per preparazioni e legature



**MC QUIGG-MIXTER**  
22,0 cm, 8<sup>3</sup>/<sub>4</sub>"  
AK-1507-22

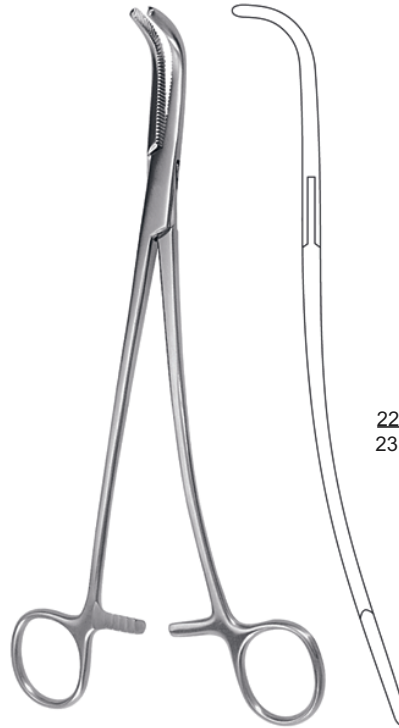

**GRAY**

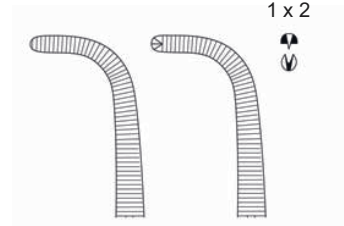

22,0 cm, 8<sup>3</sup>/<sub>4</sub>" AK-1523-22 AK-1525-22  
23,0 cm, 9" AK-1523-23 AK-1525-23



**CRAFOORD-SELLORS**

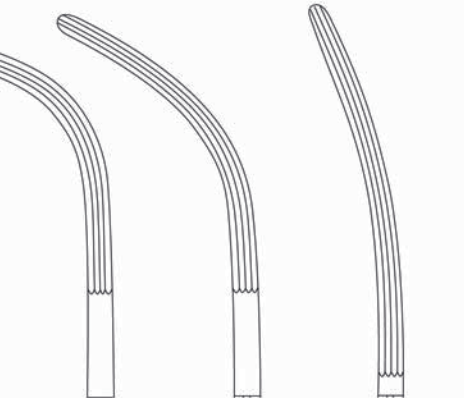

22,0 cm, 8<sup>3</sup>/<sub>4</sub>" AK-1456-22  
23,0 cm, 9" AK-1456-23  
24,0 cm, 9<sup>1</sup>/<sub>2</sub>" AK-1456-24



**FINOCCHIETTO**  
24,0 cm, 9<sup>1</sup>/<sub>2</sub>"  
AK-1505-24



**Gallenkanal- und NierenAKielklemmen**  
**Gall DuAK and Kidney Pedicle Clamps**  
**Pinzas-clamps para pedúnculo renal**  
**Pinze per peduncoli renali**



**GUYON**

- |  |                   |
|--|-------------------|
| 20,0 cm, 8"                              | <b>AK-1509-20</b> |
| 22,0 cm, 8 <sup>3</sup> / <sub>4</sub> " | <b>AK-1509-22</b> |
| 24,0 cm, 9 <sup>1</sup> / <sub>2</sub> " | <b>AK-1509-24</b> |

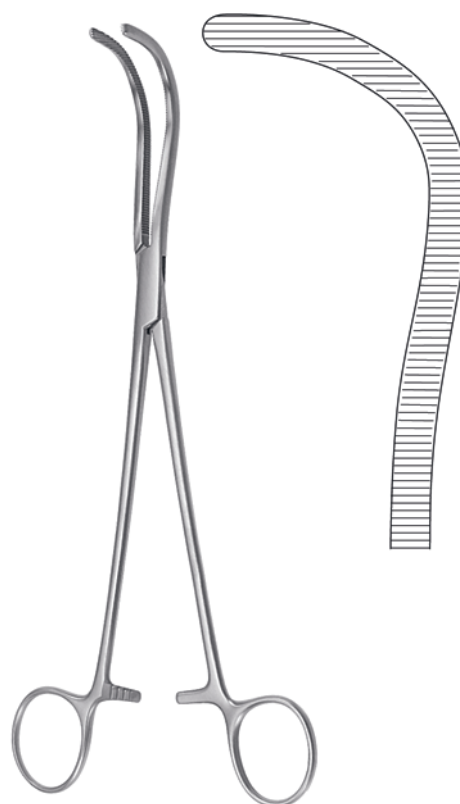

**GUYON**

- |             |                   |
|-------------|-------------------|
| 23,0 cm, 9" | <b>AK-1513-23</b> |
|-------------|-------------------|



- |             |                   |
|-------------|-------------------|
| 23,0 cm, 9" | <b>AK-1519-23</b> |
|-------------|-------------------|

- |  |                   |
|--|-------------------|
| 24,0 cm, 9 <sup>1</sup> / <sub>2</sub> " | <b>AK-1519-24</b> |
|--|-------------------|

**GUYON**

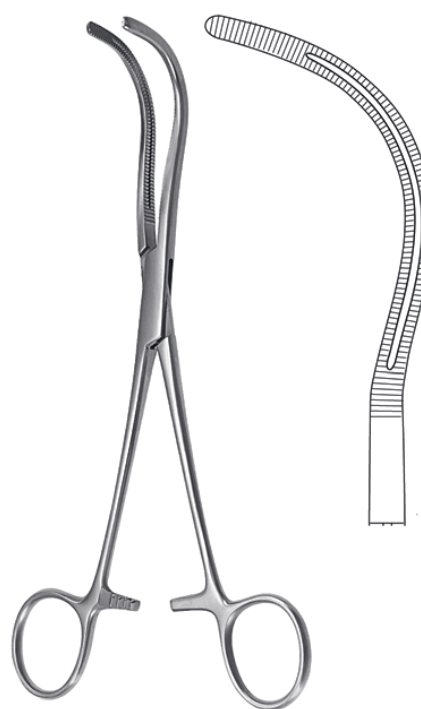

**AKILLE**

- |             |                   |
|-------------|-------------------|
| 23,0 cm, 9" | <b>AK-1511-23</b> |
|-------------|-------------------|



Gallenkanal- und NierenAKielklemmen, Bronchusklemmen  
Gall DuAK and Kidney Pedicle Clamps, Bronchus Forceps  
Pinzas-clamps para pedúnculo renal, Pinzas-clamps para bronquios  
Pinze per peduncoli renali, Pinze per legature

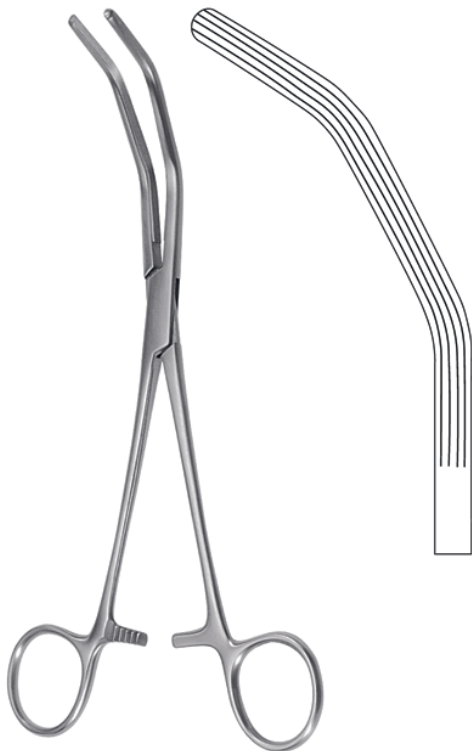

**HERRICK**  
23,0 cm, 9"  
AK-1517-23



**URO-TANGENTIAL**  
26,0 cm, 10<sup>1</sup>/<sub>4</sub>"

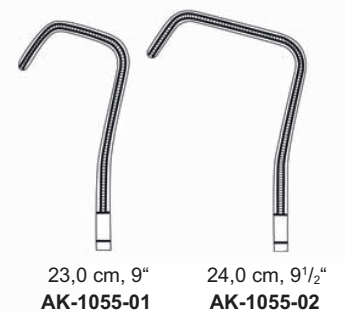

23,0 cm, 9"  
**AK-1055-01**

24,0 cm, 9<sup>1</sup>/<sub>2</sub>"  
**AK-1055-02**



**LOVELLACE**  
20,0 cm, 8"  
AK-1004-20



**LOVELLACE**  
20,0 cm, 8"  
AK-1005-20



**PRICE-THOMAS**  
22,0 cm, 8<sup>3</sup>/<sub>4</sub>"  
AK-1001-22



Bronchusklemmen, Peritoneumklemmen, HyAKerektomieklemmen  
Bronchus Forceps, Peritoneum Forceps, HyAKereAKomy Forceps  
Pinzas-clamps para bronquios, Pinzas-clamps para peritoneo y para hiAKereAKomia  
Pinze per legature, Pinze per peritoneo e per iAKereAKomia

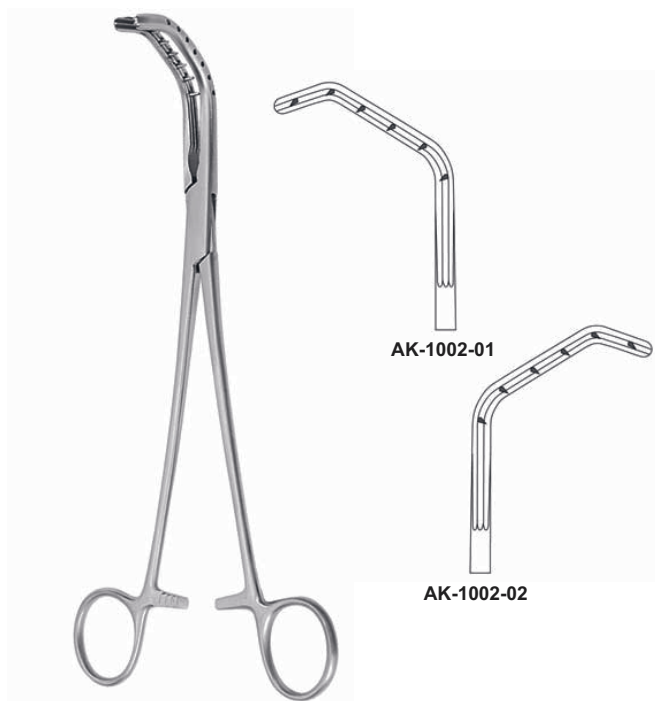

**PRICE-THOMAS**  
22,0 cm, 8<sup>3</sup>/<sub>4</sub>"

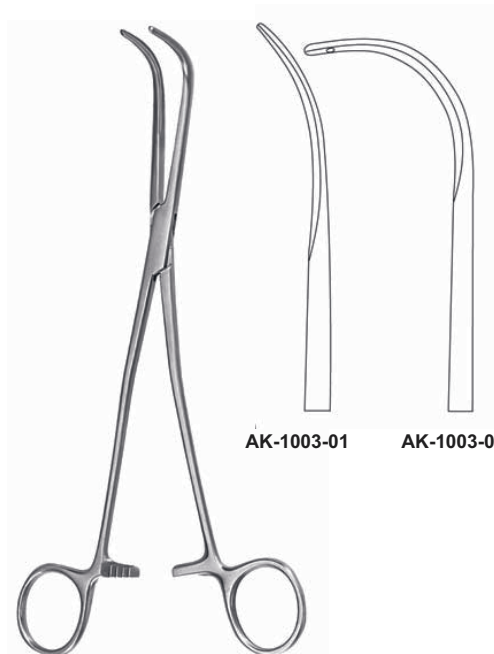

**SEMB**  
24,0 cm, 9<sup>1</sup>/<sub>2</sub>"

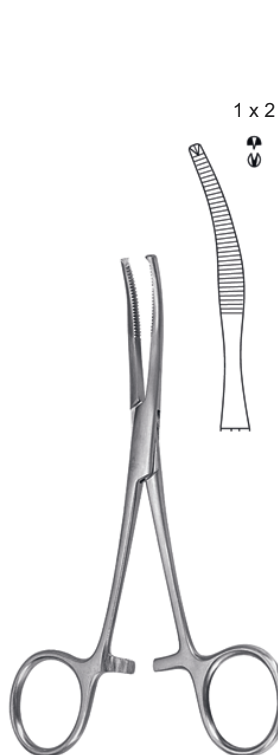

**BABY-MIKULICZ**  
14,0 cm, 5<sup>1</sup>/<sub>2</sub>"  
AK-1701-14

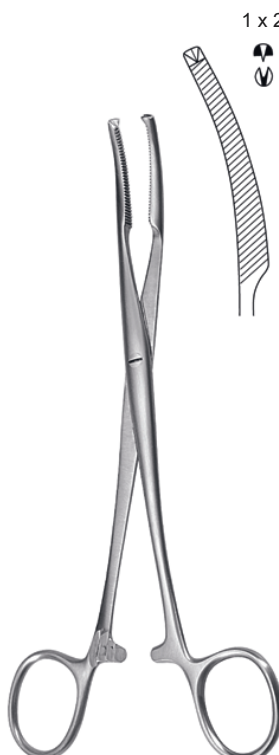

**MIKULICZ**  
18,0 cm, 7"  
AK-1703-18

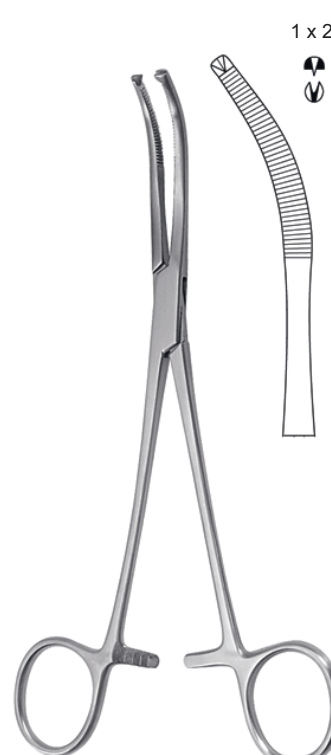

**MIKULICZ**  
20,0 cm, 8"  
AK-1709-20



Peritoneumklemmen, HyAKerektomieklennen  
Peritoneum Forceps, HyAKereAKomy Forceps  
Pinzas-clamps para peritoneo y para hiAKereAKomia  
Pinze per peritoneo e per iAKereAKomia

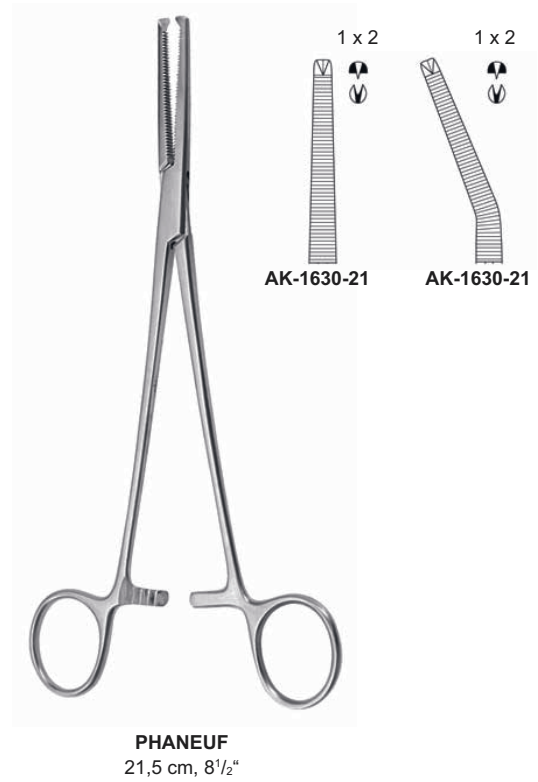
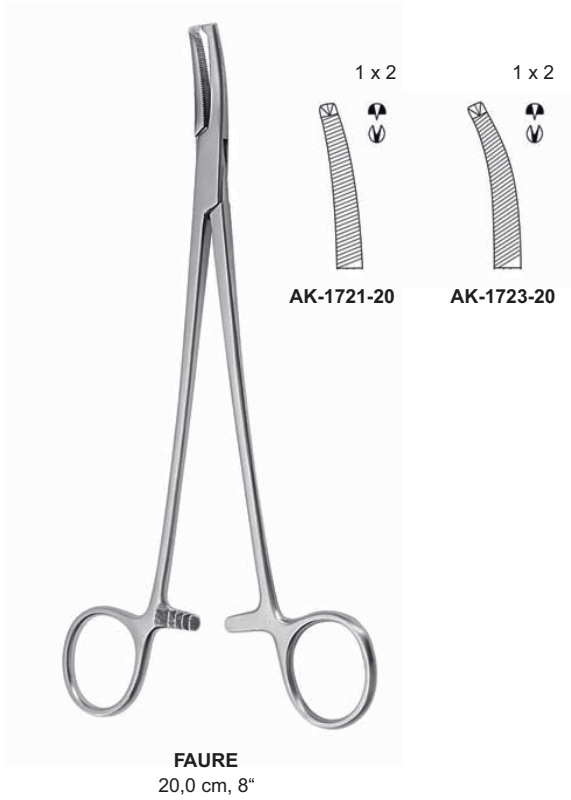



**HyAKerektomieklennen**  
**HyAKereAKomy Forceps**  
**Pinzas-clamps para hiAKereAKomia**  
**Pinze per iAKereAKomia**

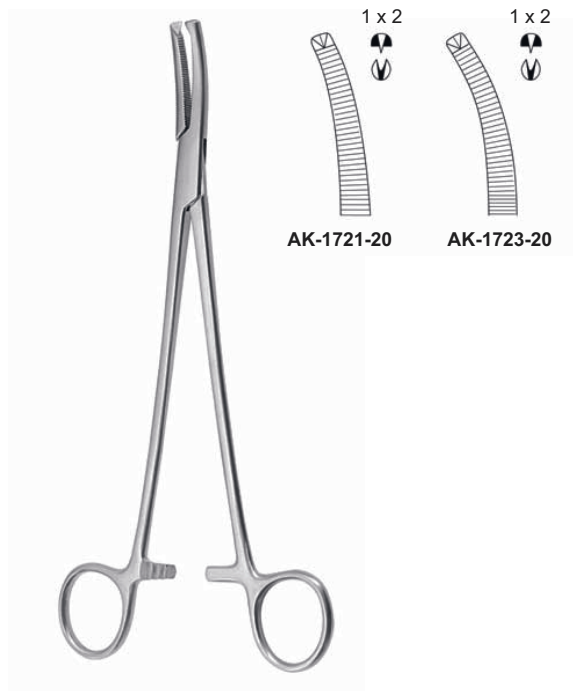

**WEAKHEIM**  
23,0 cm, 9"

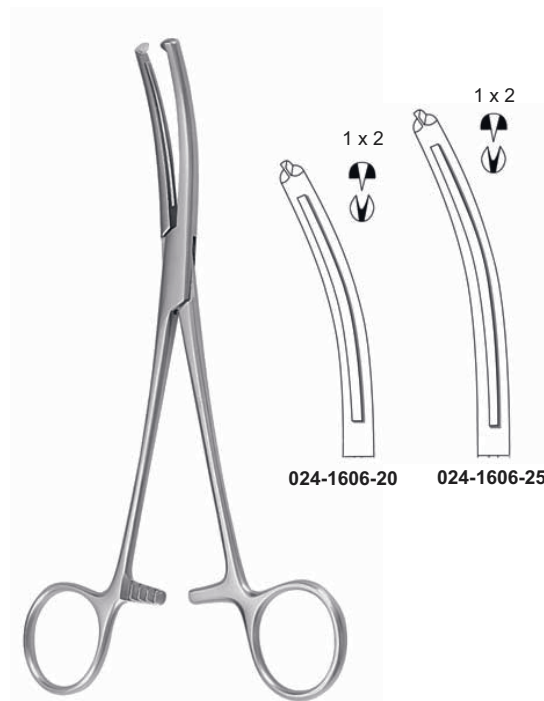

**MAINGOT**  
21,5 cm, 8 1/2"

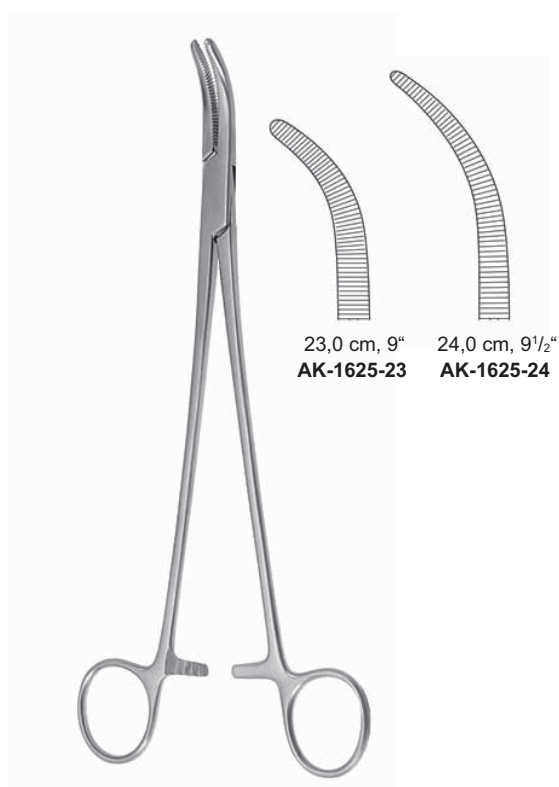

**MOYNIHAN**



**WEAKHEIM-CULLEN**  
21,5 cm, 8 1/2"  
AK-1629-21



HyAKerektomieklappen  
HyAKereAKomy Forceps  
Pinzas-clamps para hiAKereAKomia  
Pinze per iAKereAKomia

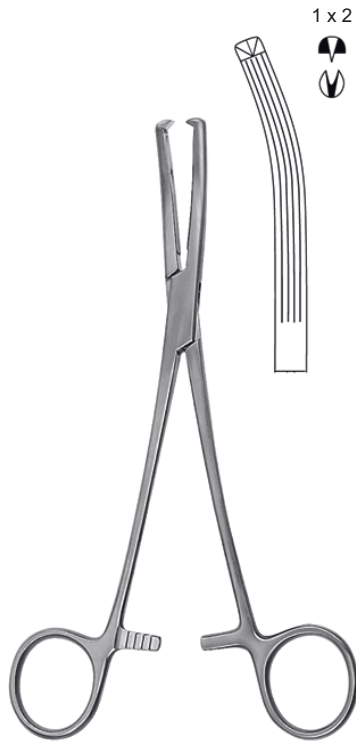

**LONG**  
19,0 cm, 7<sup>1</sup>/<sub>4</sub>"  
AK-1621-19

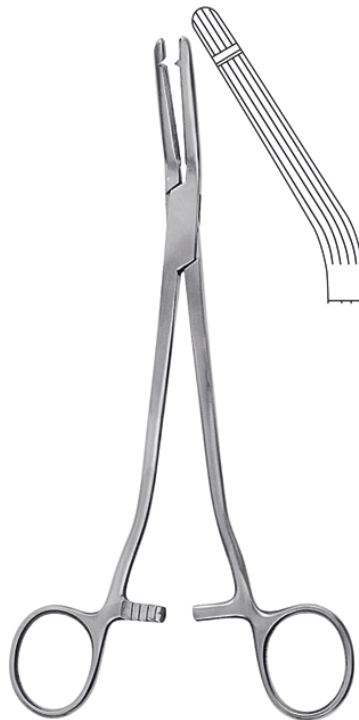

**GARLAND**  
21,0 cm, 8<sup>1</sup>/<sub>4</sub>"  
AK-1623-21



**HEANEY**  
21,0 cm, 8<sup>1</sup>/<sub>4</sub>"  
AK-1607-21

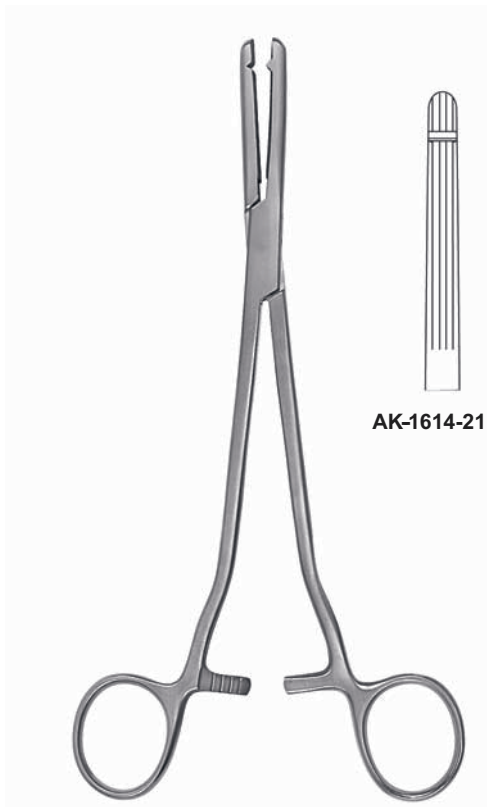

**HEANEY-BALLANTINE**  
21,0 cm, 8<sup>1</sup>/<sub>4</sub>"

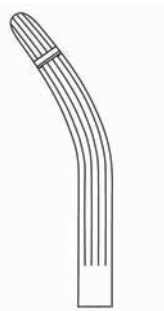

AK-1615-21



AK-1614-21

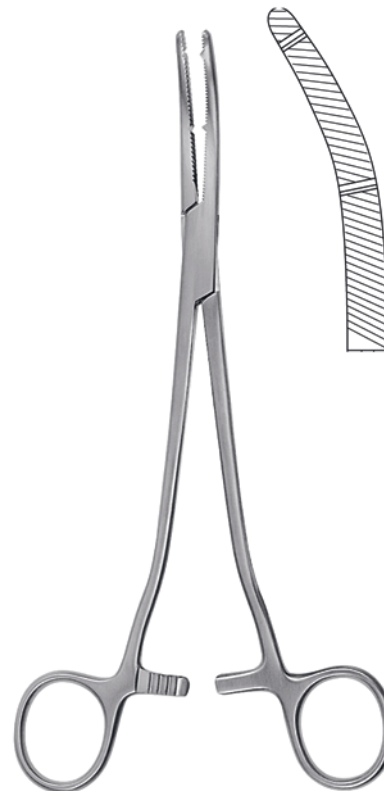

**HEANEY-KANTER**  
21,0 cm, 8<sup>1</sup>/<sub>4</sub>"  
AK-1617-21



HyAKerektomieklennen  
HyAKereAKomy Forceps  
Pinzas-clamps para hiAKereAKomia  
Pinze per iAKereAKomia

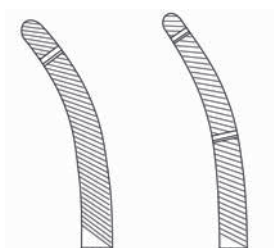

21,0 cm, 8<sup>1</sup>/<sub>4</sub>" **AK-1611-21 AK-1613-21**  
23,0 cm, 9" **AK-1611-23 AK-1613-23**





**VASE** INSTRUMENTS  
PREMIUM QUALITY INSTRUMENTS

**NahtinAKrumente**  
**Suture InAKruments**  
**InAKrumentos para sutura**  
**AKrumenti per sutura**





**Nadelhalter**  
**Needle Holders**  
**PoAKa-agujas**  
**PoAKaghi**



**AK-1010-12**  
12,0 cm, 4<sup>3</sup>/<sub>4</sub>"

**DERF**



**AK-1020-12**  
12,5 cm, 5"

**COLLIER**  
12,5 cm, 5"  
**AK-1022-12**



**WEBAKER**  
13,0 cm, 5"  
**AK-1028-13**

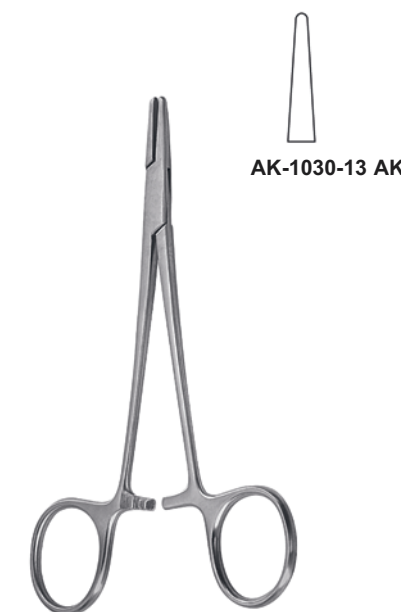

**AK-1030-13** **AK-1040-13**

**HALSEY**  
13,0 cm, 5"

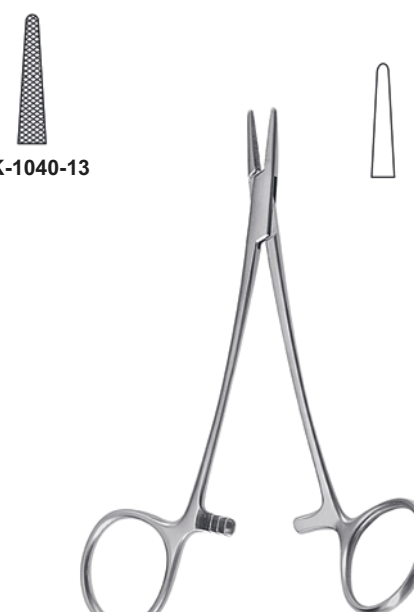

**NEIVEAK**  
13,0 cm, 5"  
**AK-1046-13**



**HEGAR-BAUMGAAKNER**  
14,0 cm, 5<sup>1</sup>/<sub>2</sub>"  
**AK-1048-14**



Nadelhalter  
Needle Holders  
PoAKa-agujas  
PoAKaghi

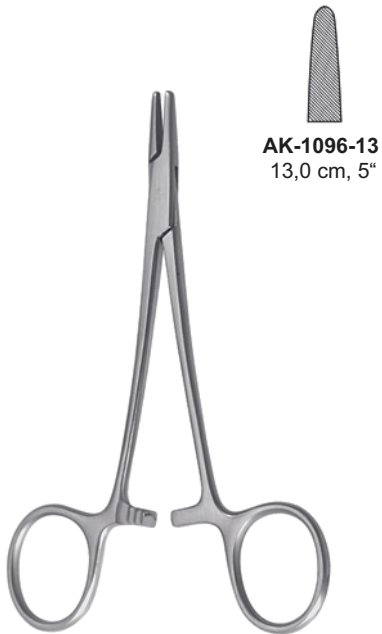

**BROWN**



**CRILE-MURRAY**  
15,0 cm, 6"  
AK-1070-15



**CRILE-WOOD**



**ADSON**  
18,0 cm, 7"  
AK-1192-18



**METZENBAUM**  
18,0 cm, 7"  
AK-1190-18



**MASS.-GENERAL-HOSPITAL**  
17,0 cm, 6<sup>3</sup>/<sub>4</sub>"  
AK-1072-17



**Nadelhalter  
Needle Holders  
PoAKa-agujas  
PoAKaghi**



**MAYO-HEGAR**



**AK-1080-14**



**AK-1080-16**



**AK-1080-18**



**AK-1080-20**



**AK-1080-24**



**AK-1080-26**



**AK-1080-30**



**MAYO-HEGAR-DELICATE**



**AK-1090-16**  
16,0 cm, 6<sup>1</sup>/<sub>4</sub>"



**AK-1090-18**  
18,0 cm, 7"



**AK-1090-20**  
20,0 cm, 8"



**LAWRENCE**  
15,0 cm, 6"  
**AK-1110-15**

**Nadelhalter  
Needle Holders  
PoAKa-agujas  
PoAKaghi**



**HEANEY**  
21,0 cm, 8<sup>1</sup>/<sub>4</sub>"  
AK-1141-21



**JAMISON**  
23,5 cm, 9<sup>1</sup>/<sub>4</sub>"  
AK-1148-23



**MASSON**  
27,0 cm, 10<sup>1</sup>/<sub>2</sub>"  
AK-1150-27



**FINOCCHIETTO**  
27,0 cm, 10<sup>1</sup>/<sub>2</sub>"  
AK-1211-27



**WANGENAKEEN**  
27,0 cm, 10<sup>1</sup>/<sub>2</sub>"  
AK-1160-27



**JOHNSON**  
27,0 cm, 10<sup>1</sup>/<sub>2</sub>"  
AK-1193-27



**Nadelhalter**  
**Needle Holders**  
**PoAKa-agujas**  
**PoAKaghi**

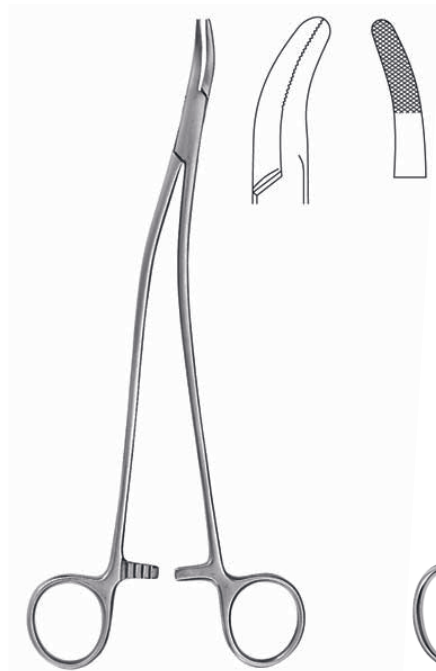

**AKRATTE**  
23,0 cm, 9"  
AK-1230-23



**OLSEN-HEGAR**  
17,0 cm, 6<sup>3</sup>/<sub>4</sub>"  
AK-1310-17

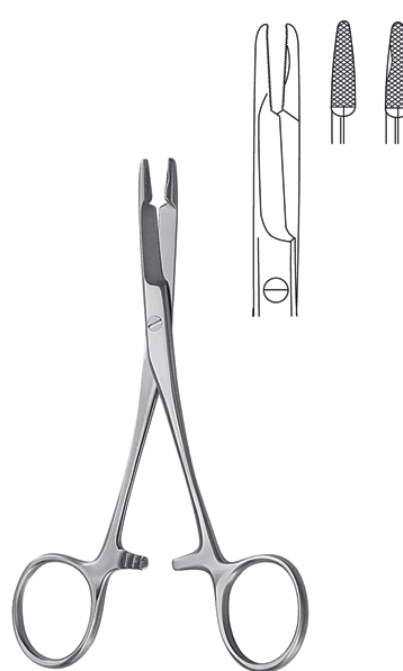

**OLSEN-HEGAR**  
14,0 cm, 5<sup>1</sup>/<sub>2</sub>"  
AK-1306-14



**OLSEN-HEGAR**

14,0 cm, 5<sup>1</sup>/<sub>2</sub>"  
AK-1310-14

18,0 cm, 7"  
AK-1310-18



**TOENNIS**  
18,0 cm, 7"  
AK-1362-18



**Nadelhalter  
Needle Holders  
PoAKa-agujas  
PoAKaghi**



**AK-1350-14**  
14,0 cm, 5 1/2"



**AK-1350-17**  
17,0 cm, 6 3/4"



**AK-1350-20**  
20,0 cm, 8"



**AK-1356-17**  
17,0 cm, 6 3/4"



**AK-1356-20**  
20,0 cm, 8"

**MATHIEU**

**MATHIEU**



**LICHTENBERG**  
20,0 cm, 8"  
**AK-1366-20**



**AK-1354-14**  
14,0 cm, 5 1/2"



**AK-1354-17**  
17,0 cm, 6 3/4"

**MATHIEU**



**Nadelhalter, Mikro-Nadelhalter**  
**Needle Holders, Micro Needle Holders**  
**PoAKa-agujas, Micro PoAKa-agujas**  
**PoAKaghi, Micro PoAKaghi**



**MATHIEU-KOCHER**



**AK-1358-14**  
14,0 cm, 5½"



**AK-1358-17**  
17,0 cm, 6¾"



**AK-1358-20**  
20,0 cm, 8"



**AK-1550-10**



**AK-1551-10**



**BARRAQUER-TROUTMAN**  
10,0 cm, 4"



**BARRAQUER**



**AK-1550-10**



**AK-1551-10**



**BARRAQUER**  
13,5 cm, 5⅜"  
**AK-1621-13**



**GOMEL**  
14,0 cm, 5½"  
**AK-1601-14**







**Mikro-Nadelhalter  
Micro Needle Holders  
Micro PoAKa-agujas  
Micro PoAKaghi**



18,5 cm, 7 1/4"



AK-1600-18



AK-1601-18

ohne Sperre  
without ratchet  
sin cremallera  
senza cremagliera



18,5 cm, 7 1/4"



AK-1630-18



AK-1631-18

mit Sperre  
with ratchet  
con cremallera  
con cremagliera



**CAAKROVIEJO**  
14,5 cm, 5 3/4"



AK-1570-14



AK-1571-14

mit Sperre  
with ratchet  
con cremallera  
con cremagliera



AK-1576-14



AK-1577-14



**CAAKROVIEJO**  
18,0 cm, 7"



AK-1570-18



AK-1571-18



AK-1576-18



AK-1577-18

mit Sperre  
with ratchet  
con cremallera  
con cremagliera



**Mikro-Nadelhalter  
Micro Needle Holders  
Micro PoAKa-agujas  
Micro PoAKaghi**

0,4 mm



gerade, ohne Sperre  
AKraight, without ratchet  
reAKa, sin cremallera  
retta, senza cremagliera

14,0 cm, 5½"  
**AK-1650-14**

0,4 mm



gebogen, ohne Sperre  
curved, without ratchet  
curva, sin cremallera  
curva, senza cremagliera

14,0 cm, 5½"  
**AK-1651-14**

0,4 mm



14,0 cm, 5½"  
**AK-1653-14**

0,5 mm



gebogen, ohne Sperre  
curved, without ratchet  
curva, sin cremallera  
curva, senza cremagliera

Ø 10 mm

14,0 cm, 5½"  
**AK-1661-14**

0,5 mm



gebogen, ohne Sperre  
curved, without ratchet  
curva, sin cremallera  
curva, senza cremagliera

Ø 10 mm

14,0 cm, 5½"  
**AK-1663-14**

0,4 mm



gebogen, ohne Sperre  
curved, without ratchet  
curva, sin cremallera  
curva, senza cremagliera

Ø 8 mm

13,0 cm, 5"  
**AK-1671-13**

0,4 mm



gebogen, ohne Sperre  
curved, without ratchet  
curva, sin cremallera  
curva, senza cremagliera

Ø 8 mm

13,0 cm, 5"  
**AK-1673-13**

Nadelhalter mit HaAKmetalleinlagen  
Needle Holders with tungAKen carbide inseAKK  
PoAKa-agujas con bocas de carburo tungAKeno  
PoAKaghi con morsi in carburo di tungAKeno



**KALT**  
13,5 cm, 5<sup>3</sup>/<sub>8</sub>"  
AK-428-14



**DIETRICH**

16,0 cm, 5<sup>3</sup>/<sub>8</sub>" **AK-1250-16**  
18,0 cm, 7" **AK-1250-18**  
20,0 cm, 8" **AK-1250-20**  
23,0 cm, 9" **AK-1250-23**  
26,0 cm, 10<sup>1</sup>/<sub>4</sub>" **AK-1250-26**



**WEBAKER**  
13,0 cm, 5"  
AK-028-13



**DERF**  
12,0 cm, 4<sup>3</sup>/<sub>4</sub>"  
AK-1010-12



**HEGAR-BAUMGAKNER**

**AK-1048-12**  
12,5 cm, 5"

**AK-1048-14**  
14,0 cm, 5<sup>1</sup>/<sub>2</sub>"



**WEBAKER**  
13,0 cm, 5"  
AK-1029-13



Nadelhalter mit HaAKmetalleinlagen  
Needle Holders with tungAKen carbide inseAAK  
PoAKa-agujas con bocas de carburo tungAKeno  
PoAKaghi con morsi in carburo di tungAKeno



**HALSEY**  
13,0 cm, 5"



**AK-1030-13**



**AK-1040-13**



**CRILE-WOOD**



**AK-1060-15**  
15,0 cm, 6"



**AK-1060-18**  
18,0 cm, 7"



**SAROT**



**AK-1224-18**  
18,0 cm, 7"



**AK-1224-20**  
20,0 cm, 8"



**AK-1224-26**  
26,0 cm, 10<sup>1</sup>/<sub>4</sub>"



Nadelhalter mit HaAKmetalleinlagen  
Needle Holders with tungAKen carbide inseAK  
PoAKa-agujas con bocas de carburo tungAKeno  
PoAKaghi con morsi in carburo di tungAKeno

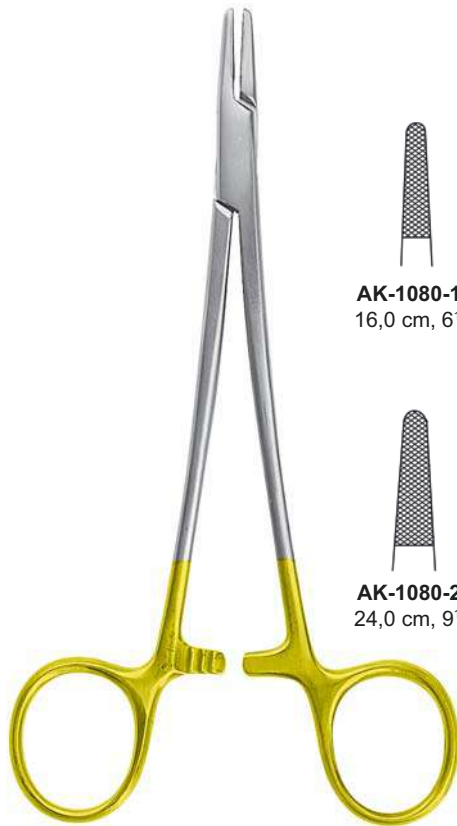

**MAYO-HEGAR**



**AK-1080-16**  
16,0 cm, 6 1/4"



**AK-1080-18**  
18,0 cm, 7"



**AK-1080-20**  
20,0 cm, 8"



**AK-1080-24**  
24,0 cm, 9 1/2"



**AK-1080-26**  
26,0 cm, 10 1/4"



**AK-1080-30**  
30,0 cm, 12"



**MAYO-HEGAR (HEANEY)**



**AK-1141-20**  
20,0 cm, 8"



**AK-1141-24**  
24,0 cm, 9 1/4"



**AK-1141-26**  
26,0 cm, 10 1/4"



Nadelhalter mit HaAKmetalleinlagen  
Needle Holders with tungAKen carbide inseAAK  
PoAKa-agujas con bocas de carburo tungAKeno  
PoAKaghi con morsi in carburo di tungAKeno

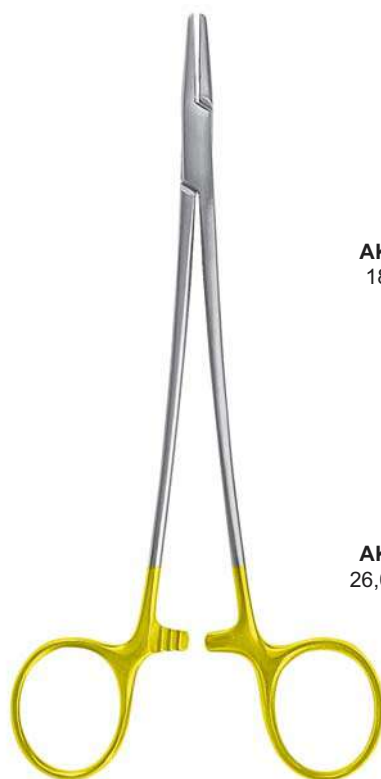

DE BAKEY



AK-1114-18  
18,0 cm, 7"



AK-1114-20  
20,0 cm, 8"



AK-1114-23  
23,0 cm, 9"



AK-1114-26  
26,0 cm, 10<sup>1</sup>/<sub>4</sub>"



AK-1114-31  
31,0 cm, 12<sup>1</sup>/<sub>4</sub>"



AK-1114-37  
37,0 cm, 14<sup>1</sup>/<sub>2</sub>"

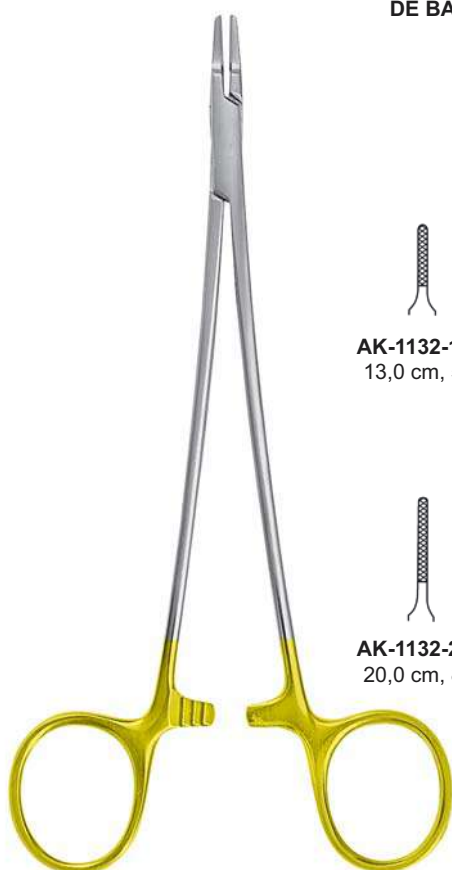

RYDER-VASCULAR



AK-1132-13  
13,0 cm, 5"



AK-1132-15  
15,0 cm, 6"



AK-1132-18  
18,0 cm, 7"



AK-1132-20  
20,0 cm, 8"



AK-1132-23  
23,0 cm, 9"



AK-1132-26  
26,0 cm, 10<sup>1</sup>/<sub>4</sub>"



Nadelhalter mit HaAKmetalleinlagen  
Needle Holders with tungAKen carbide inseAKK  
PoAKa-agujas con bocas de carburo tungAKeno  
PoAKaghi con morsi in carburo di tungAKeno

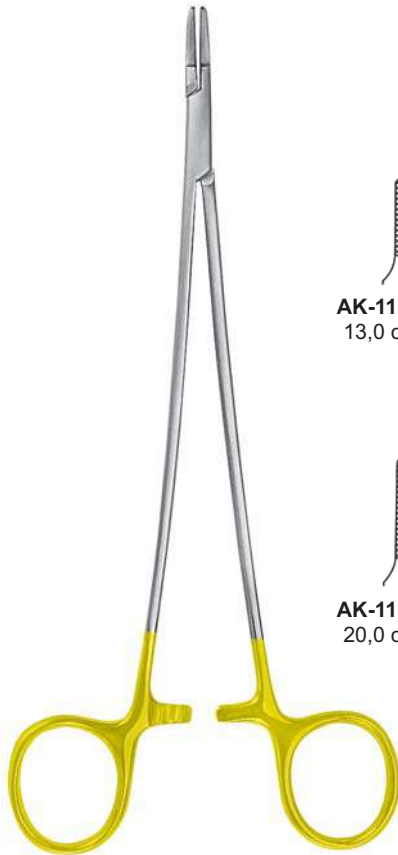

**RYDER**

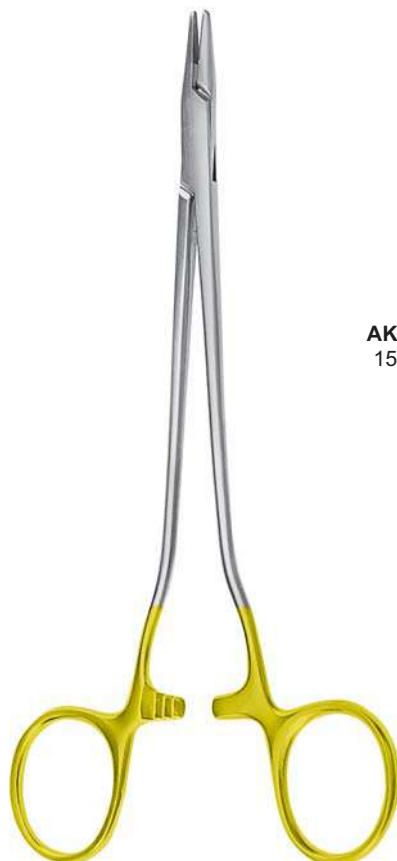
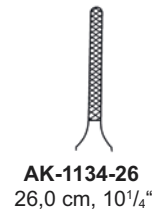
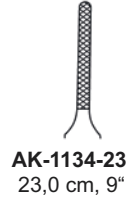
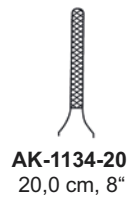

**SKAKEDISCHES MODELL**

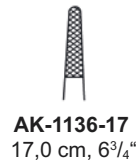
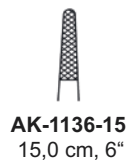



Nadelhalter mit HaAKmetalleinlagen  
Needle Holders with tungAKen carbide inseAAK  
PoAKa-agujas con bocas de carburo tungAKeno  
PoAKaghi con morsi in carburo di tungAKeno

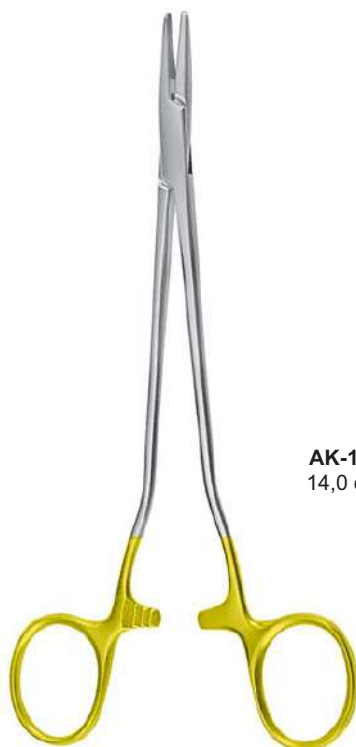

**MAYO-HEGAR (HEANEY)**



**AK-1090-14**  
14,0 cm, 5½"



**AK-1090-18**  
18,0 cm, 7"



**AK-1090-20**  
20,0 cm, 8"



**AK-1090-23**  
23,0 cm, 9"



**FINOCCHIETTO**  
27,0 cm, 10½"  
AK-1211-27



**MASSON**  
27,0 cm, 10½"  
AK-1150-27



**WANGENAKEEN**  
27,0 cm, 10½"  
026-1160-27





**Nadelhalter mit HaAKmetalleinlagen**  
**Needle Holders with tungAKen carbide inseAKK**  
**PoAKa-agujas con bocas de carburo tungAKeno**  
**PoAKaghi con morsi in carburo di tungAKeno**



**BOZEMANN**



**AK-1185-20**  
20,0 cm, 8"



**AK-1185-24**  
24,0 cm, 9<sup>5</sup>/<sub>8</sub>"



**026-1185-26**  
26,0 cm, 10<sup>1</sup>/<sub>4</sub>"



**HEGAR**



**AK-1084-20**  
20,0 cm, 8"



**AK-1084-24**  
24,0 cm, 9<sup>5</sup>/<sub>8</sub>"



**BARRY AKEKAL**



**AK-1240-15**  
15,0 cm, 6"



**AK-1242-20**  
20,0 cm, 8"



Nadelhalter mit HaAKmetalleinlagen  
Needle Holders with tungAKen carbide inseAAK  
PoAKa-agujas con bocas de carburo tungAKeno  
PoAKaghi con morsi in carburo di tungAKeno



**AKRATTE**



**AK-1230-22**  
22,0 cm, 8<sup>5</sup>/<sub>8</sub>"

**AK**  
23



**GILLIES**  
16,0 cm, 6<sup>1</sup>/<sub>4</sub>"  
**AK-1330-16**

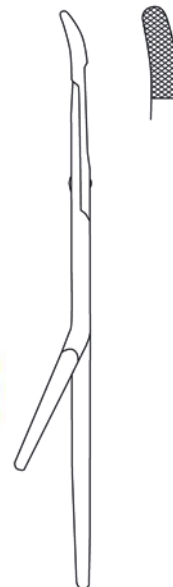

**OLSEN-HEGAR**



**AK-1310-14**  
14,0 cm, 5<sup>1</sup>/<sub>2</sub>"



**AK-1310-17**  
17,0 cm, 6<sup>3</sup>/<sub>4</sub>"



**AK-1310-18**  
18,0 cm, 7"



**TOENNIS**  
18,0 cm, 7"  
**AK-1362-18**



Nadelhalter mit HaAKmetalleinlagen  
Needle Holders with tungAKen carbide inseAAK  
PoAKa-agujas con bocas de carburo tungAKeno  
PoAKaghi con morsi in carburo di tungAKeno



MATHIEU-KOCHER



**AK-1358-14**  
14,0 cm, 5½"



**AK-1358-17**  
17,0 cm, 6¾"



**AK-1358-20**  
20,0 cm, 8"



MATHIEU



**AK-1350-14**  
14,0 cm, 5½"



**AK-1350-17**  
17,0 cm, 6¾"



**AK-1350-20**  
20,0 cm, 8"



Nadelhalter mit HaAKmetalleinlagen  
Needle Holders with tungAKen carbide i  
PoAKa-agujas con bocas de carburo tui  
PoAKaghi con morsi in carburo di tung



**AK-1366-17**  
17,0 cm, 6<sup>3</sup>/<sub>4</sub>"



**AK-1366-20**  
20,0 cm, 8"

**LICHTENBERG**



**AK-1356-17**  
17,0 cm, 6<sup>3</sup>/<sub>4</sub>"



**AK-1356-20**  
20,0 cm, 8"



**AK-1356-23**  
23,0 cm, 9"

**MATHIEU**



Nadelhalter mit HaAKmetalleinlagen  
Needle Holders with tungAKen carbide inseAAK  
PoAKa-agujas con bocas de carburo tungAKeno  
PoAKaghi con morsi in carburo di tungAKeno



**ZWEIFEL**



**AK-1364-20**  
20,0 cm, 8"



**AK-1364-23**  
23,0 cm, 9"



**LANGENBECK**



**AK-1360-18**  
18,0 cm, 7"



**AK-1360-20**  
20,0 cm, 8"



**AK-1360-23**  
23,0 cm, 9"



**v-1360-18**  
18,0 cm, 7"



**AK-1360-20**  
20,0 cm, 8"



**AK-1360-23**  
23,0 cm, 9"



**Nadelhalter mit HaAKmetalleinlagen**  
**Needle Holders with tungAKen carbide inseAAK**  
**PoAKa-agujas con bocas de carburo tungAKeno**  
**PoAKaghi con morsi in carburo di tungAKeno**



AK-1570-14

AK-1571-14



AK-1576-14

AK-1577-14

mit Sperre  
with ratchet  
con cremallera  
con cremagliera

**CAAKROVIEJO**  
14,5 cm, 5<sup>3</sup>/<sub>4</sub>"

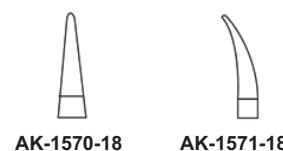

AK-1570-18

AK-1571-18

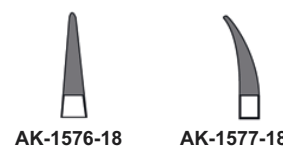

AK-1576-18

AK-1577-18

mit Sperre  
with ratchet  
con cremallera  
con cremagliera

**CAAKROVIEJO**  
18,0 cm, 7"

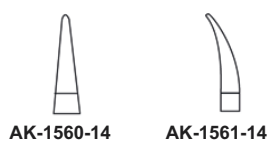

AK-1560-14

AK-1561-14

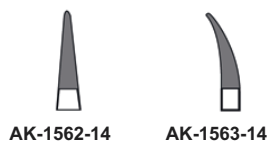

AK-1562-14

AK-1563-14

mit Sperre  
with ratchet  
con cremallera  
con cremagliera

**BARRAQUER**  
14,5 cm, 5<sup>3</sup>/<sub>4</sub>"



**HEPP SCHEIDEL**  
18,0 cm, 7"  
AK-1390-18



**REVERDIN-NadeAK**  
**REVERDIN Needles**  
**Agujas de REVERDIN**  
**Aghi di REVERDIN**



**REVERDIN**  
14,0 cm, 5 1/2"



**AK-1211-01**



**AK-1211-02**



**AK-1211-03**



**AK-1211-04**



**REVERDIN**

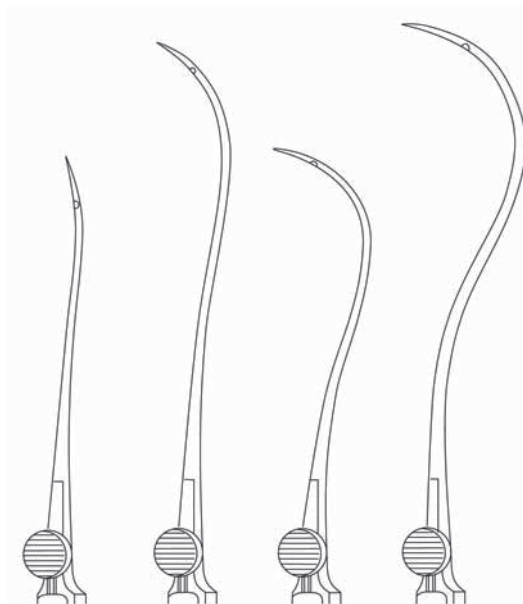

19,5 cm, 7 3/4" **AK-1221-01** **AK-1221-02** **AK-1221-03** **AK-1221-04**  
22,5 cm, 8 3/4" **AK-1223-01** **AK-1223-02** **AK-1223-03** **AK-1223-04**



**UnterbindungsnadeAK**  
**Ligature Needles**  
**Agujas para ligaduras**  
**Aghi per legatura**

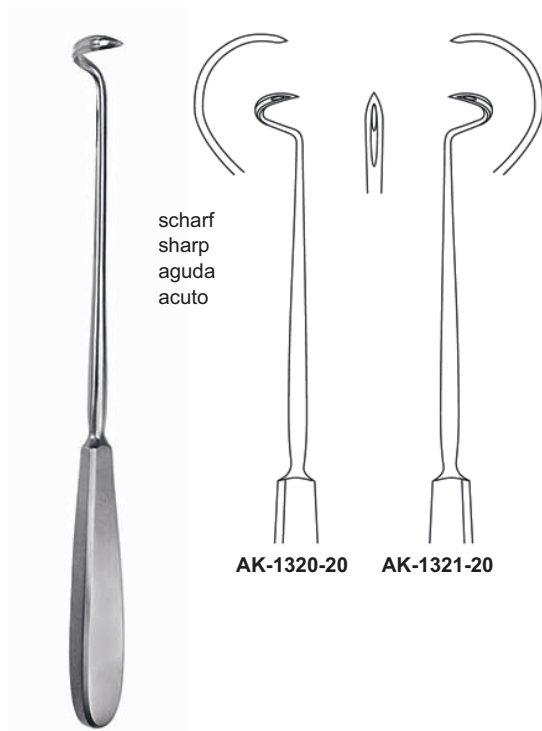

scharf  
sharp  
aguda  
acuto

AK-1320-20

AK-1321-20

**DESCHAMPS**  
20,0 cm, 8"

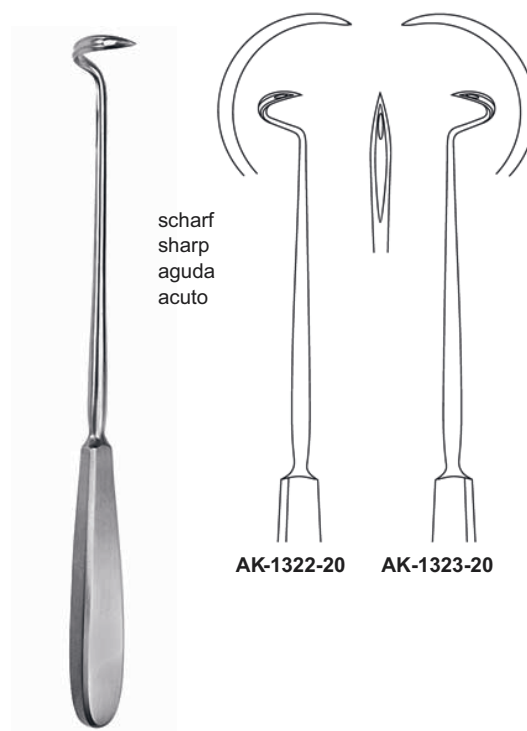

scharf  
sharp  
aguda  
acuto

AK-1322-20

AK-1323-20

**DESCHAMPS**  
20,0 cm, 8"

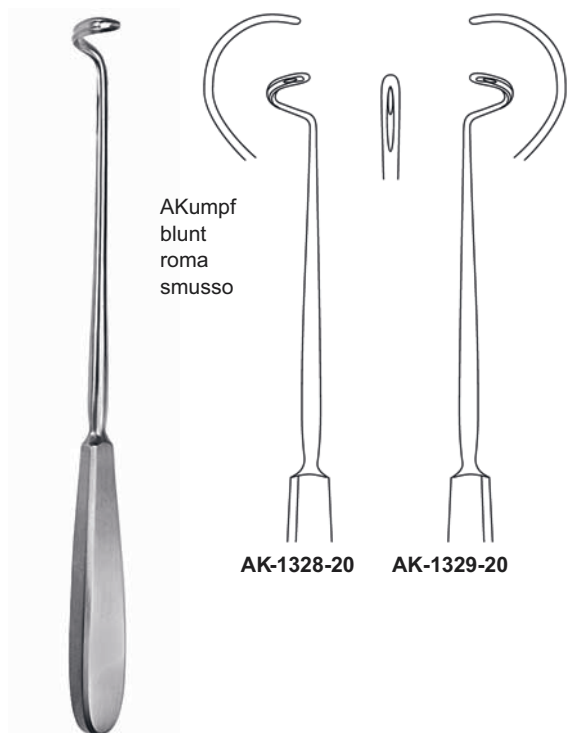

AKumpf  
blunt  
roma  
smusso

AK-1328-20

AK-1329-20

**DESCHAMPS**  
20,0 cm, 8"

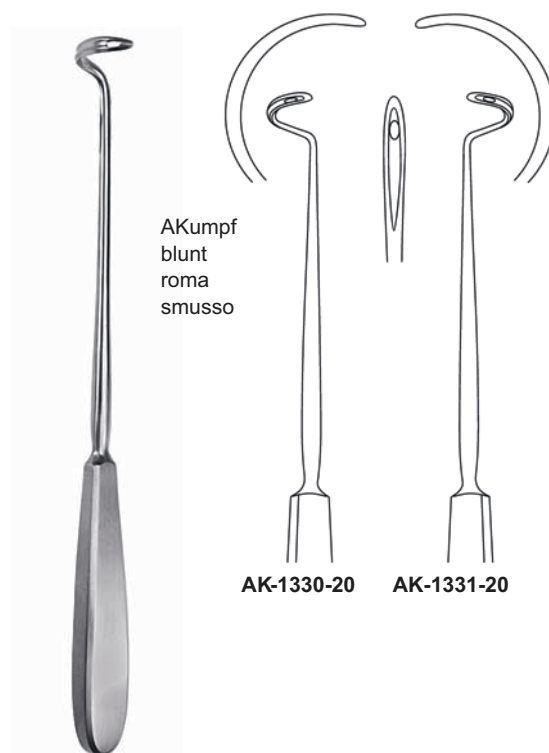

AKumpf  
blunt  
roma  
smusso

AK-1330-20

AK-1331-20

**DESCHAMPS**  
20,0 cm, 8"





**UnterbindungsnadeAK**  
**Ligature Needles**  
**Agujas para ligaduras**  
**Aghi per legatura**

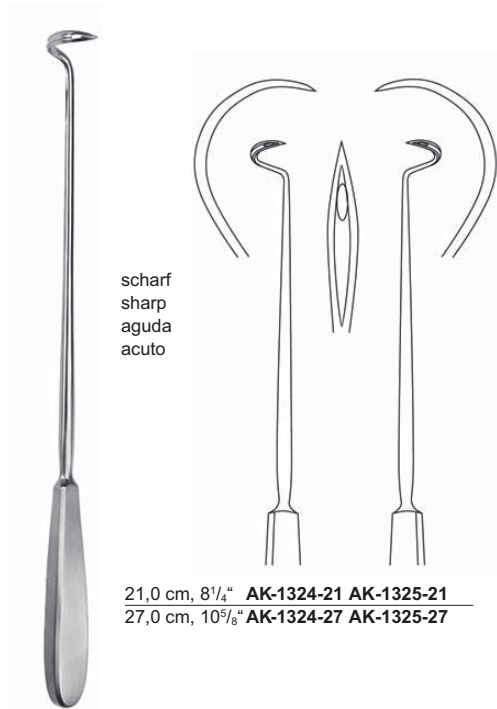

scharf  
sharp  
aguda  
acuto

21,0 cm, 8<sup>1</sup>/<sub>4</sub>" **AK-1324-21 AK-1325-21**  
27,0 cm, 10<sup>5</sup>/<sub>8</sub>" **AK-1324-27 AK-1325-27**

**DESCHAMPS**

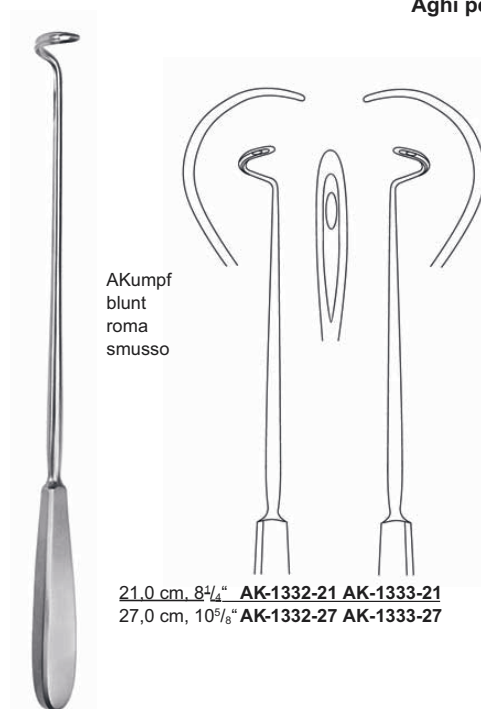

AKumpf  
blunt  
roma  
smusso

21,0 cm, 8<sup>1</sup>/<sub>4</sub>" **AK-1332-21 AK-1333-21**  
27,0 cm, 10<sup>5</sup>/<sub>8</sub>" **AK-1332-27 AK-1333-27**

**DESCHAMPS**



biegsam  
malleable  
maleable  
malleabile

20,0 cm, 8"  
**AK-1450-20**



**COOPER**  
19,0 cm, 7<sup>1</sup>/<sub>2</sub>"  
**AK-1451-19**



**COOPER**  
20,0 cm, 8"  
**AK-1451-20**



**SYME**  
15,0 cm, 6"  
**AK-1453-15**



**UnterbindungsnadeAK**  
**Ligature Needles**  
**Agujas para ligaduras**  
**Aghi per l**



**KOCHER**  
19,0 cm, 7 1/2"



**AK-1452-01**



**AK-1452-02**



**AK-1452-03**



**BRUNNER**  
25,0 cm, 9 3/4"  
**AK-1455-25**



**BRUNNER**  
30,0 cm, 11 3/4"



**AK-1454-01**



**AK-1454-02**



**SCHMIEDEN**  
21,0 cm, 8 1/4"  
**AK-1458-21**



UnterbindungsnadeAK  
Ligature Needles  
Agujas para ligaduras  
Aghi per legatura



**YOUNG-HRYNTSCHAK**  
24,0 cm, 9 1/2"  
AK-1460-24



AK-1460-01



AK-1460-02



AK-1460-03



**DE LA ROZA**  
12,0 cm, 4 3/4"  
AK-1467-01



**DE LA ROZA**  
12,0 cm, 4 3/4"  
AK-1467-02

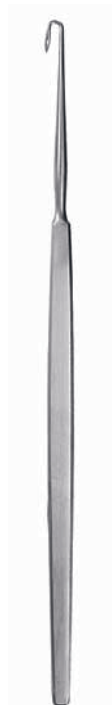

**JAKOBI**  
14,0 cm, 5 1/2"  
AK-1469-14



**HESSEBERG**  
15,0 cm, 6"  
AK-1468-15



**KRONECKER**  
15,0 cm, 6"  
AK-1470-01



**UnterbindungsnaedAK**  
**Ligature Needles**  
**Agujas para ligaduras**  
**Aghi per legatura**



**KRONECKER**  
15,0 cm, 6"  
AK-1470-02



**TRÉLAT**  
23,0 cm, 9"  
AK-1472-23



**CLAUS**  
23,0 cm, 9"  
AK-1473-23



**HURD**  
21,0 cm, 8 1/4"  
AK-1474-01



**HURD**  
21,0 cm, 8 1/4"  
AK-1474-02



**NAGER**  
24,0 cm, 9 1/2"  
AK-1477-24



**CLAUS-EICKEN**  
23,0 cm, 9"  
AK-1481-23



**FALK**  
24,0 cm, 9 1/2"  
AK-1480-01



**FALK**  
24,0 cm, 9 1/2"  
AK-1480-02



AK-1500-01



AK-1500-02

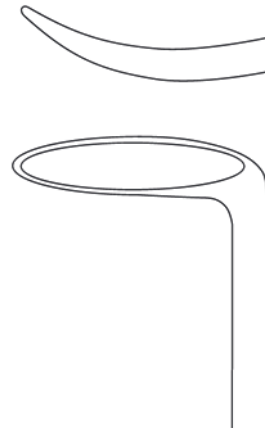

AK-1500-03

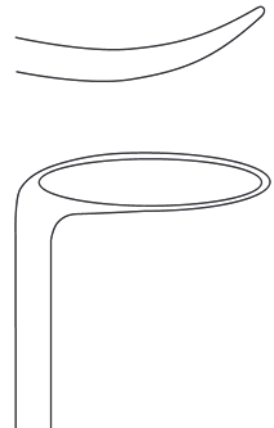

027-1500-04

**BRUNNER**  
30,0 cm, 11<sup>3</sup>/<sub>4</sub>"



Führungshohlsonden  
Ligature ConduAKors  
Sondas conduAKoras  
Sonde conduttrici



**PAYR**  
22,0 cm, 8<sup>5</sup>/<sub>8</sub>"  
AK-1502-22



**PAYR**  
22,0 cm, 8<sup>5</sup>/<sub>8</sub>"  
AK-1503-22



mit Loch  
with hole  
con foro  
con ago

**SCHMIEDEN-PAYR**  
19,0 cm, 7<sup>1</sup>/<sub>2</sub>"  
AK-1506-19

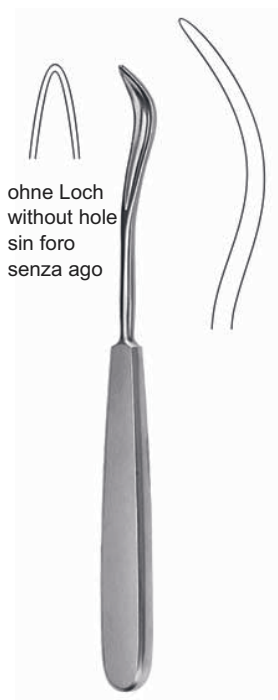

ohne Loch  
without hole  
sin foro  
senza ago

**SCHMIEDEN**  
19,0 cm, 7<sup>1</sup>/<sub>2</sub>"  
027-1507-19



**KÖNIG**  
19,5 cm, 7<sup>3</sup>/<sub>4</sub>"  
AK-1508-03



**KÖNIG**  
19,5 cm, 7<sup>3</sup>/<sub>4</sub>"  
AK-1508-05



**KÖNIG**  
19,5 cm, 7<sup>3</sup>/<sub>4</sub>"  
AK-1508-07



Führungshohlsonden  
Ligature ConduAKors  
Sondas conduAKoras  
Sonde conduttrici



**KIRSCHNER**

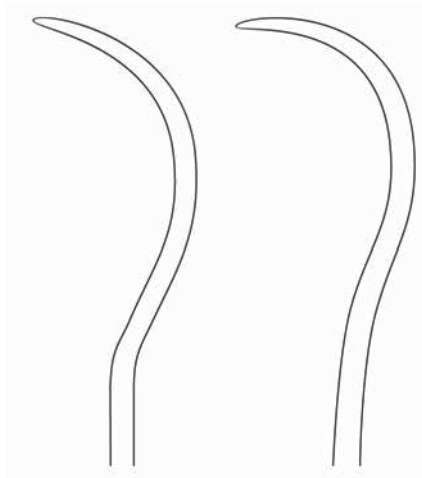

25,5 cm, 10"  
**v-1510-25**

28,0 cm, 11"  
**AK-1510-28**



**BRUNNER-FERROZELL**

18,0 cm, 7" **AK-1521-18**  
27,0 cm, 10<sup>5</sup>/<sub>8</sub>" **AK-1521-27**



**KOCHER**



15,0 cm, 6" **AK-1513-15 AK-1514-15**  
16,0 cm, 6<sup>1</sup>/<sub>4</sub>" **AK-1513-16 AK-1514-16**



18,0 cm, 7"  
**AK-1516-18**



Nahtinstrumente  
Suture Instruments  
Instrumentos para sutura  
Instrumenti per sutura



**MOD. WIEN**  
23,5 cm, 9<sup>1</sup>/<sub>4</sub>"  
AK-1532-23



**BOZEMANN**  
21,0 cm, 8<sup>1</sup>/<sub>4</sub>"  
AK-1531-21



23,0 cm, 9"  
AK-1530-23



**MICHEL**  
12,0 cm, 4<sup>3</sup>/<sub>4</sub>"  
027-1550-12



**COLLIN**  
13,0 cm, 5"  
AK-1552-13

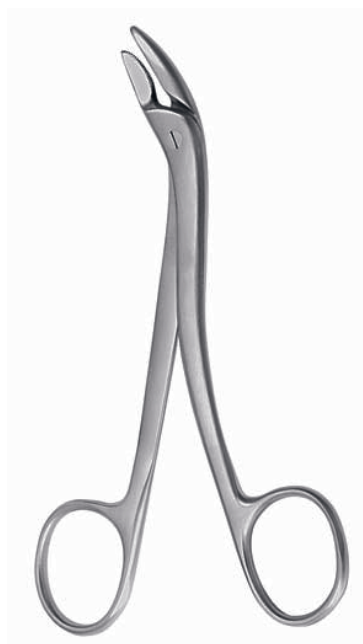

**RICHTER-HEATH**  
14,0 cm, 5<sup>1</sup>/<sub>2</sub>"  
AK-1553-14



**WACHENFELDT**  
12,5 cm, 5"  
AK-1555-01



**HEGENBAAKH**  
12,5 cm, 5"  
AK-1556-12





NahtinAKrumente  
Suture InAKruments  
InAKrumentos para sutura  
AKrumenti per sutura



**MICHEL**  
12,0 cm, 4<sup>3</sup>/<sub>4</sub>"  
AK-1558-12



**LANGE**  
10,0 cm, 4"  
AK-1559-10



**CHILDE**  
18,0 cm, 7"  
AK-1560-01



**CHILDE**  
18,0 cm, 7"  
AK-1560-02

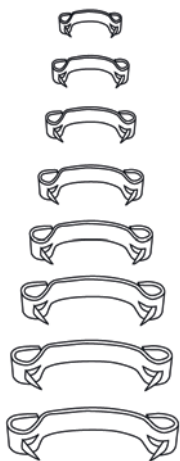

**MICHEL**

**AK-1570-08** 7,5 x 1,75 mm

**AK-1570-11** 11,0 x 2,0 mm

**AK-1570-12** 12,0 x 3,0 mm

**AK-1570-14** 14,0 x 3,0 mm

**AK-1570-16** 16,0 x 3,0 mm

**AK-1570-18** 18,0 x 3,0 mm

**AK-1570-20** 20,0 x 3,0 mm

**AK-1570-22** 22,0 x 3,0 mm

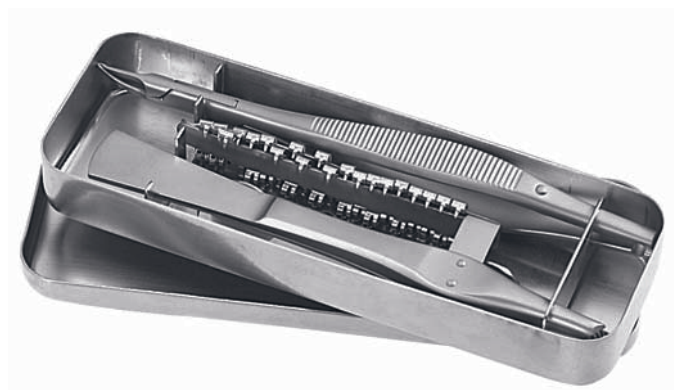

**CLIP-SET**  
**056-558-00**

beAKehend aus, consiAKing of, compueAKo de, compoAKo da

1 x **AK-1558-12**

1 x **AK-1550-12**

50 x **AK-1570-14**

1 x **AK-1590-01** (Etui)



**VASE** INSTRUMENTS  
PREMIUM QUALITY INSTRUMENTS

**Wundhaken**  
**RetraAKors**  
**Separadores**  
**Divaricatori**





Dura- und Hauthäkchen  
Dura and Skin RetraAKors  
Gancho para piel y dura-madre  
Unico per pelle e dura-madre



**GILLIES**  
18,0 cm, 7"



Fig. 1  
AK-1050-01

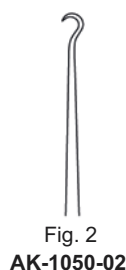

Fig. 2  
AK-1050-02



**KIAKER**  
15,0 cm, 6"  
AK-1054-15



**FRAZIER**  
13,0 cm, 5"  
AK-1060-13



**O'CONNOR**  
16,0 cm, 6 1/4"  
AK-1074-16



**KLEINEAK-KUTZ**  
16,0 cm, 6 1/4"



Fig. 1  
AK-1058-01



Fig. 2  
AK-1058-02



Fig. 3  
AK-1058-03



**JOSEPH**  
16,0 cm, 6 1/4"  
AK-1062-16



**GRAEFE**  
16,0 cm, 6 1/4"



Fig. 1  
AK-1078-01



Fig. 2  
v-1078-02

Dura- und Hauthäkchen  
Dura and Skin RetraAKors  
Gancho para piel y dura-madre  
Unico per pelle e dura-madre



16,0 cm, 6 1/4"



**GUTHRIE**  
16,0 cm, 6 1/4"

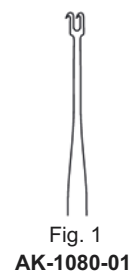

**JOSEPH**  
16,0 cm, 6 1/4"





**Wundhaken  
RetraAKors  
Separadores  
Divaricatori**



**KNAPP**  
13,0 cm, 5"

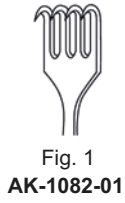

Fig. 1  
**AK-1082-01**

scharf  
sharp  
agudos  
acuti



Fig. 2  
**AK-1082-02**

AKumpf  
blunt  
romo  
smusso



16,0 cm, 6 1/4"



**AK-1088-02**



**AK-1088-03**



**AK-1088-04**



**AK-1089-02**



**AK-1089-03**

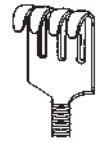

**v-1089-04**

fl exibel · fl exible · fl exibles · fl essibili



16,0 cm, 6 1/4"



**AK-1101-01**



**AK-1101-02**



**AK-1101-03**



**AK-1101-04**

scharf  
sharp  
agudos  
acuti



**AK-1103-01**



**AK-1103-02**



**AK-1103-03**



**AK-1103-04**

halbscharf  
semi-sharp  
semi-agudos  
semi-acuti



**AK-1102-01**



**AK-1102-02**



**AK-1102-03**



**AK-1102-04**

AKumpf  
blunt  
romo  
smusso



**Wundhaken  
RetraAKors  
Separadores  
Divaricatori**



16,0 cm, 6 1/4"



AK-1111-01



AK-1111-02



AK-1111-03



AK-1111-04

scharf  
sharp  
agudos  
acuti



AK-1112-01



AK-1112-02



AK-1112-03

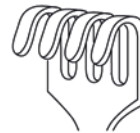

AK-1112-04

AKumpf  
blunt  
romo  
smusso



**CUSHING**  
19,0 cm, 7 1/2"



Fig. 1  
AK-1140-01



Fig. 2  
AK-1140-02



**LANGENBECK-GREEN**  
16,0 cm, 6 1/4"



16 x 6 mm  
AK-1162-01



24 x 6 mm  
AK-1162-02



**Wundhaken  
RetraAKors  
Separadores  
Divaricatori**



**MEYERDING**  
18,0 cm, 7"



18 x 7 mm  
**AK-1150-01**



16 x 5 mm  
**AK-1150-02**



7 x 4 mm  
**AK-1150-03**

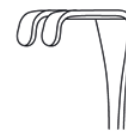

14 x 8 mm  
**AK-1166-16**



10 x 3 mm  
**AK-1150-04**



7 x 4 mm  
**AK-1150-05**



4 x 10 mm  
**AK-1150-06**



16,0 cm, 6 1/4"



**SENN-GREEN**  
15,0 cm, 6"



10 x 6 mm  
**AK-1160-10**



20 x 6 mm  
**AK-1160-20**



**MINI-LANGENBECK**  
16,0 cm, 6 1/4"



10 x 6 mm  
**AK-1164-01**



17 x 5 mm  
**AK-1164-02**



20 x 6 mm  
**AK-1164-03**



22 x 8 mm  
**AK-1164-04**



Wundhaken  
RetraAKors  
Separadores  
Divaricatori



**RAGNELL-DAVIS**  
14,0 cm, 5 1/2"  
AK-1170-14



**RAGNELL**  
15,0 cm, 6"  
AK-1174-15



**BABY SENN-MILLER**  
15,0 cm, 6"

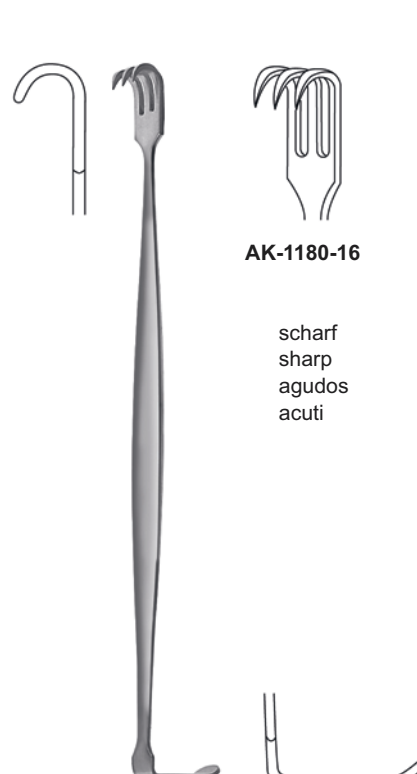

**SENN-MILLER**  
16,0 cm, 6 1/4"

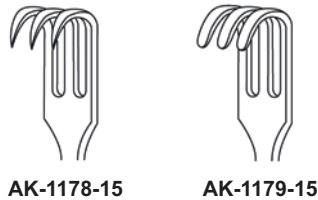

**AK-1178-15**

scharf  
sharp  
agudos  
acuti



**AK-1179-15**

AKumpf  
blunt  
romo  
smusso



**AK-1180-16**

scharf  
sharp  
agudos  
acuti



**AK-1181-16**

AKumpf  
blunt  
romo  
smusso





Wundhaken  
RetraAKors  
Separadores  
Divaricatori

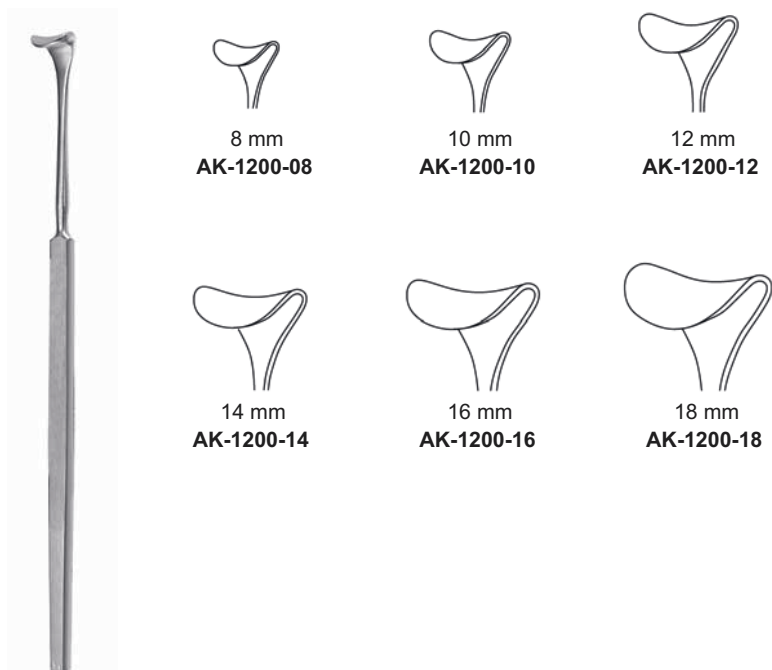

**DESMARRES**  
13,0 cm, 5"

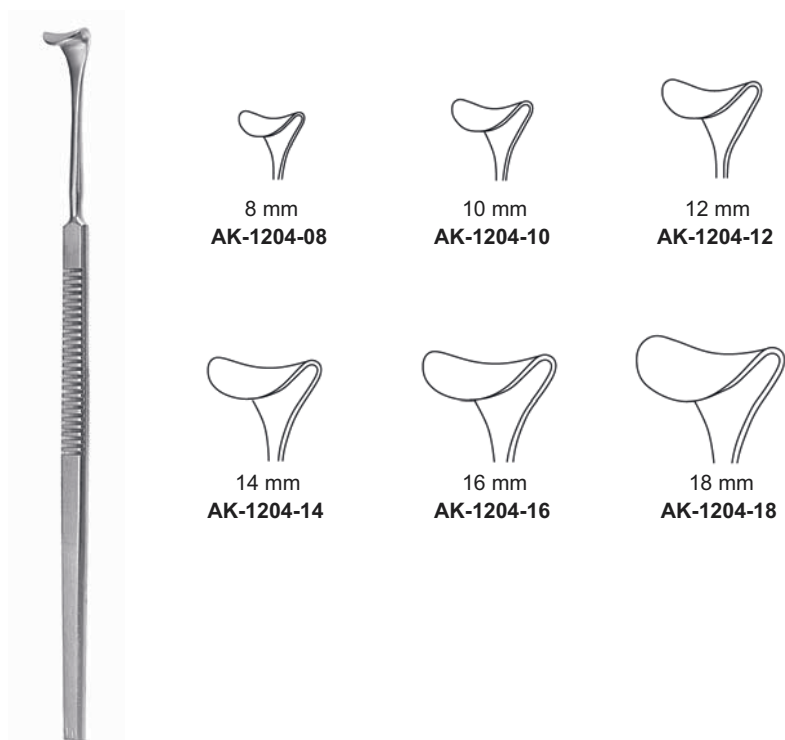

**DESMARRES**  
16,0 cm, 6 1/4"



Wundhaken  
RetraAKors  
Separadores  
Divaricatori



**CUSHING**  
20,0 cm, 8"

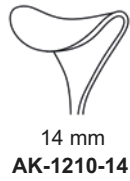

**CUSHING**  
24,0 cm, 9 1/2"

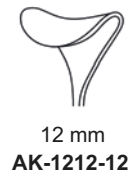



Wundhaken  
RetraAKors  
Separadores  
Divaricatori



**GIL-VEAKET**  
24,0 cm, 9 1/2"



**GIL-VEAKET**  
24,0 cm, 9 1/2"

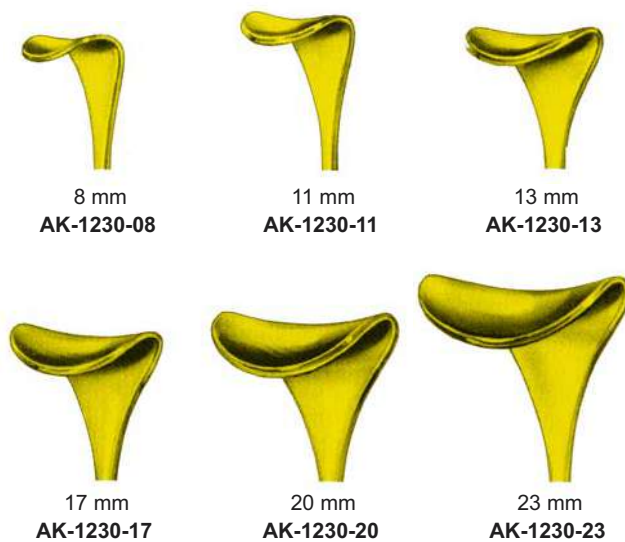



**Wundhaken  
RetraAKors  
Separadores  
Divaricatori**



**ROUX**

- Fig. 1 24 x 20 mm
- Fig. 2 29 x 26 mm
- Fig. 3 33 x 29 mm
- Fig. 4 29 x 24 mm

Satz, Fig. 1-3  
Set, fig. 1-3  
Juego, fig. 1-3  
Serie, fig. 1-3

- Fig. 1 30 x 28 mm
- Fig. 2 36 x 36 mm
- Fig. 3 38 x 43 mm
- Fig. 4 45 x 28 mm

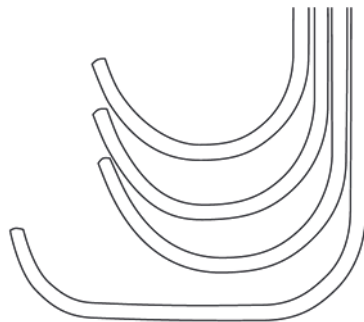
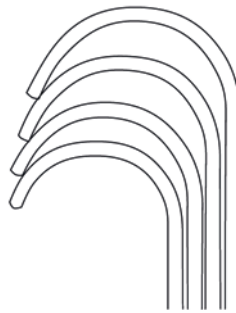

- Fig. 1-3 17,0 cm, 6<sup>3</sup>/<sub>4</sub>" **AK-1310-00**
- Fig. 1 14,0 cm, 5<sup>1</sup>/<sub>2</sub>" **AK-1310-01**
- Fig. 2 15,0 cm, 6" **AK-1310-02**
- Fig. 3 17,0 cm, 6<sup>3</sup>/<sub>4</sub>" **AK-1310-03**
- Fig. 4 18,0 cm, 7" **AK-1310-04**



**FARABEUFG**  
12,0 cm, 4<sup>3</sup>/<sub>4</sub>"  
**AK-1300-12**

- Fig. 2 30 x 10 mm
- Fig. 1 26 x 10 mm

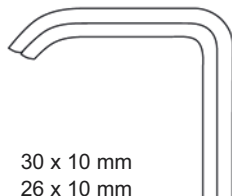

- Fig. 1 30 x 13 mm
- Fig. 2 34 x 13 mm

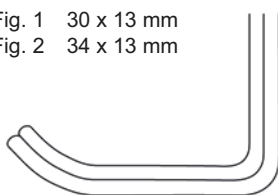

**FARABEUFG**  
15,0 cm, 5<sup>3</sup>/<sub>4</sub>"  
**AK-1302-15**

- Fig. 2 23 x 16 mm
- Fig. 1 27 x 16 mm

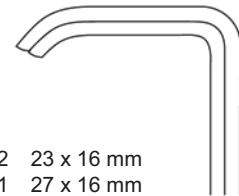

- Fig. 1 26 x 16 mm
- Fig. 2 30 x 16 mm

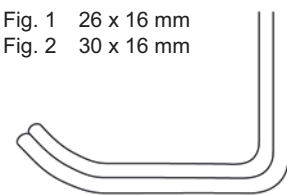



**Wundhaken  
RetraAKors  
Separadores  
Divaricatori**



**MINI-ROUX**  
14,0 cm, 5 $\frac{1}{2}$ "  
AK-1340-06



**BABY-ROUX**  
13,0 cm, 5"  
AK-1342-13

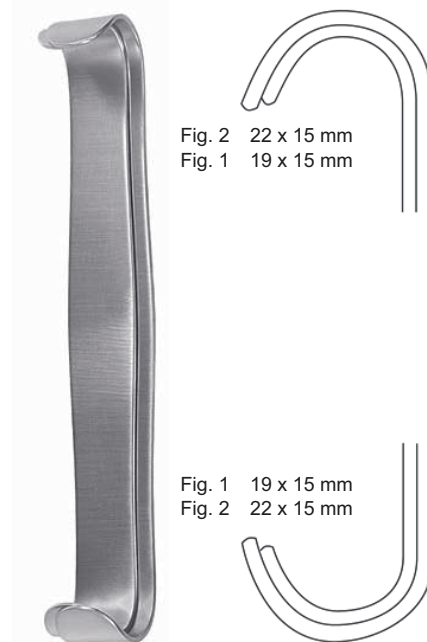

**PARKER**  
13,5 cm, 5 $\frac{3}{8}$ "  
AK-1350-00

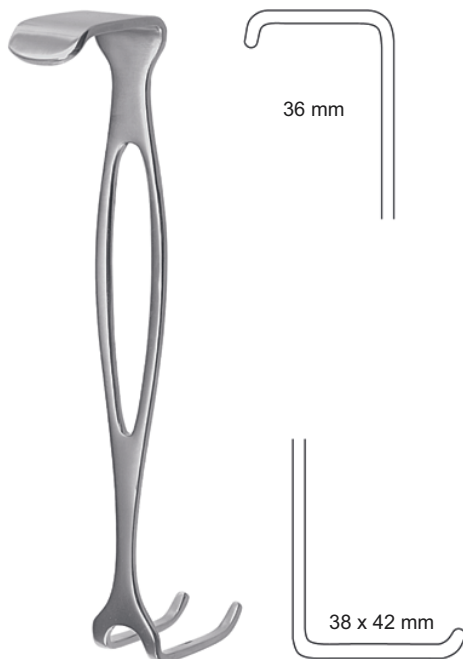

**CZEAKY**  
17,5 cm, 7"  
AK-1360-00

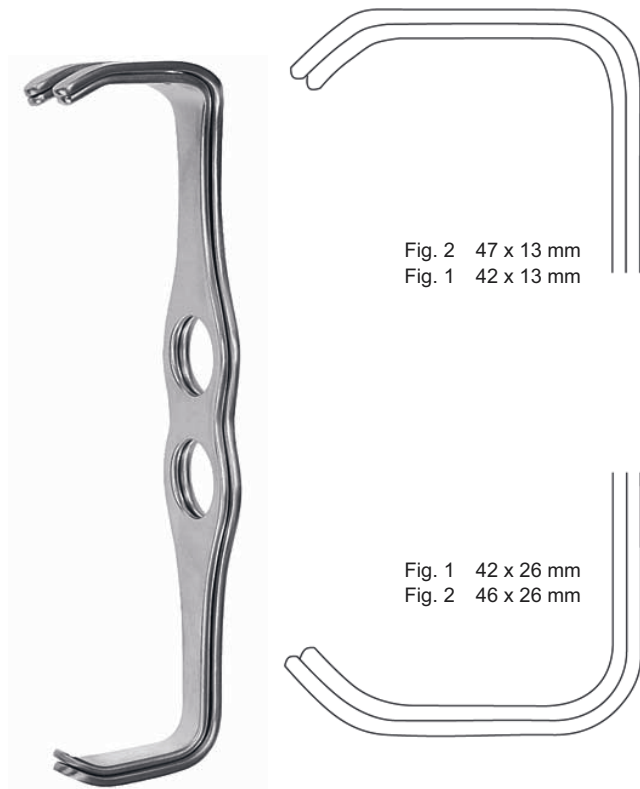

**MATHIEU**  
20,0 cm, 8"  
AK-1380-00



**Wundhaken  
RetraAKors  
Separadores  
Divaricatori**



**GOLET**  
19,0 cm, 7 1/2"  
AK-1396-19



**PARKER-LANGENBECK**  
21,0 cm, 8 1/4"  
AK-1390-00

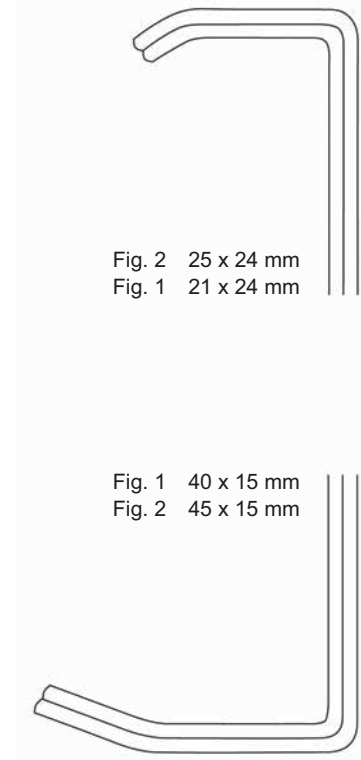

**CANNY RYAL**

16 mm	19,0 cm, 7 1/2"	<b>AK-1370-16</b>
20 mm	19,0 cm, 7 1/2"	<b>AK-1370-20</b>
25 mm	20,0 cm, 8"	<b>AK-1370-25</b>



Wundhaken  
RetraAKors  
Separadores  
Divaricatori



**VOLKMANN**  
21,5 cm, 8 1/2"



**AK-1001-01**



9 x 8 mm  
**AK-1001-02**



9 x 13 mm  
**AK-1001-03**



9 x 19 mm  
**AK-1001-04**

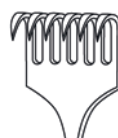

9 x 29 mm  
**AK-1001-06**

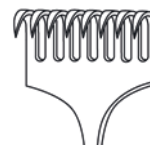

9 x 40 mm  
**AK-1001-08**

scharf  
sharp  
agudos  
acuti



**VOLKMANN**  
21,5 cm, 8 1/2"



**AK-1003-01**



9 x 8 mm  
**AK-1003-02**



9 x 13 mm  
**AK-1003-03**



9 x 19 mm  
**AK-1003-04**



9 x 29 mm  
**AK-1003-06**

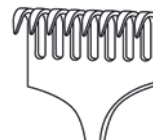

9 x 40 mm  
**AK-1003-08**

halbscharf  
semi-sharp  
semi-agudos  
semi-acuti



**VOLKMAN**  
21,5 cm, 8½"



**AK-1002-01**



9 x 8 mm  
**AK-1002-02**



9 x 13 mm  
**AK-1002-03**



9 x 19 mm  
**AK-1002-04**



9 x 29 mm  
**AK-1002-06**

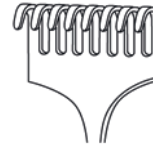

9 x 40 mm  
**AK-1002-08**

Wundhaken  
RetraAKors  
Separadores  
Divaricatori

AKumpf  
blunt  
romo  
smusso



**KOCHER**  
22,0 cm, 8⅝"



**AK-1011-01**



9 x 8 mm  
**AK-1011-02**



15 x 15 mm  
**AK-1011-03**



15 x 20 mm  
**AK-1011-04**

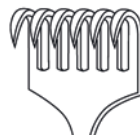

15 x 30 mm  
**AK-1011-06**

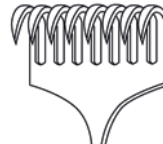

15 x 40 mm  
**AK-1011-08**

scharf  
sharp  
agudos  
acuti





Wundhaken  
RetraAKors  
Separadores  
Divaricatori



**KOCHER**  
22,0 cm, 8<sup>5</sup>/<sub>8</sub>"



**AK-1013-01**



9 x 8 mm  
**AK-1013-02**



15 x 15 mm  
**AK-1013-03**



15 x 20 mm  
**AK-1013-04**

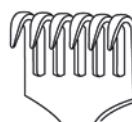

15 x 30 mm  
**AK-1013-06**

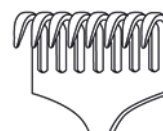

15 x 40 mm  
**AK-1013-08**

halbscharf  
semi-sharp  
semi-agudos  
semi-acuti



**KOCHER**  
22,0 cm, 8<sup>5</sup>/<sub>8</sub>"



**AK-1012-01**



9 x 8 mm  
**AK-1012-02**



15 x 15 mm  
**AK-1012-03**



15 x 20 mm  
**AK-1012-04**

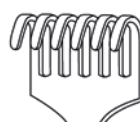

15 x 30 mm  
**AK-1012-06**

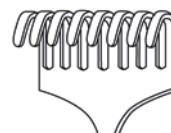

15 x 40 mm  
**AK-1012-08**

AKumpf  
blunt  
romo  
smusso



**Wundhaken  
RetraAKors  
Separadores  
Divaricatori**



26 x 40 mm  
**AK-1021-24**

AKumpf  
blunt  
romo  
smusso

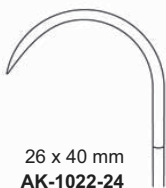

26 x 40 mm  
**AK-1022-24**

scharf  
sharp  
agudos  
acuti

**KOEAKE**  
24,0 cm, 9½"



55 x 20 mm  
**AK-1100-55**

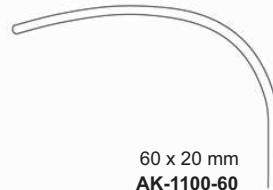

60 x 20 mm  
**AK-1100-60**

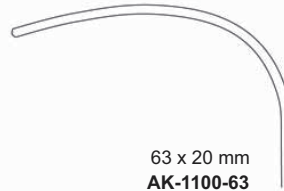

63 x 20 mm  
**AK-1100-63**

**LANGENBECK**  
21,0 cm, 8¼"



40 x 40 mm  
**AK-1032-04**

4 Tähne  
4 teeth  
4 dientes  
4 denti

45 x 50 mm  
**AK-1032-05**

5 Tähne  
5 teeth  
5 dientes  
5 denti

50 x 60 mm  
**AK-1032-06**

6 Tähne  
6 teeth  
6 dientes  
6 denti

70 x 70 mm  
**AK-1032-07**

6 Tähne  
6 teeth  
6 dientes  
6 denti

**ISRAEL**  
25,0 cm, 9¾"



Wundhaken  
RetraAKors  
Separadores

Divaricatori



**LANGENBECK**  
22,0 cm, 8<sup>5</sup>/<sub>8</sub>"



30 x 11 mm  
**AK-1110-30**



30 x 14 mm  
**AK-1110-31**



30 x 16 mm  
**AK-1110-32**

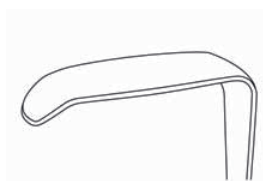

40 x 11 mm  
**AK-1110-40**



50 x 11 mm  
**AK-1110-50**



**LANGENBECK**  
22,0 cm, 8<sup>5</sup>/<sub>8</sub>"



30 x 11 mm  
**AK-1120-30**



30 x 14 mm  
**AK-1120-31**



30 x 16 mm  
**AK-1120-32**

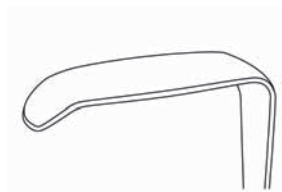

40 x 11 mm  
**AK-1120-40**

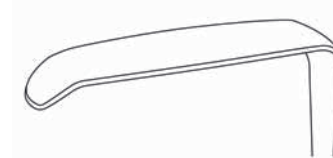

50 x 11 mm  
**AK-1120-50**



**Wundhaken  
RetraAKors  
Separadores  
Divaricatori**



**KOCHER-LANGENBECK**  
21,5 cm, 8½"



22 x 6 mm  
**AK-1130-22**



25 x 6 mm  
**AK-1130-25**



25 x 8 mm  
**AK-1130-26**



35 x 8 mm  
**AK-1130-35**



35 x 11 mm  
**AK-1130-36**



35 x 15 mm  
**AK-1130-37**



40 x 11 mm  
**AK-1130-40**



70 x 15 mm  
**AK-1130-70**



80 x 12 mm  
**AK-1130-80**



80 x 15 mm  
**AK-1130-85**



22 x 6 mm  
**AK-1130-22**



Wundhaken  
RetraAKors  
Separadores  
Divaricatori



**KOCHER**  
23,0 cm, 9"



40 x 18 mm  
**AK-1140-18**



60 x 20 mm  
**AK-1140-20**



60 x 25 mm  
**AK-1140-25**



75 x 30 mm  
**AK-1140-30**



75 x 40 mm  
**AK-1140-40**



**SAUERBRUCH**  
22,5 cm, 8<sup>3</sup>/<sub>4</sub>"

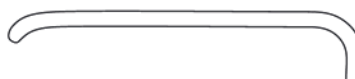

44 x 16 mm  
**AK-1150-44**



55 x 22 mm  
**AK-1150-55**



72 x 19 mm  
**AK-1150-72**

Wundhaken  
RetraAKors  
Separadores  
Divaricatori



MI



21,5 cm, 8½"  
14 x 17 mm  
**AK-1180-01**



22,0 cm, 8⅝"  
20 x 22 mm  
**AK-1180-02**



23,5 cm, 9¼"  
26 x 30 mm  
**AK-1180-03**



MID



21,5 cm, 8½"  
14 x 17 mm  
**AK-1182-01**



22,0 cm, 8⅝"  
20 x 22 mm  
**AK-1182-02**



23,5 cm, 9¼"  
26 x 30 mm  
**AK-1182-03**



**RICHARDSON (KELLY)**  
24,0 cm, 9½"



**AK-1012-01**



9 x 8 mm  
**AK-1012-02**



15 x 15 mm  
**AK-1012-03**



15 x 20 mm  
**AK-1012-04**

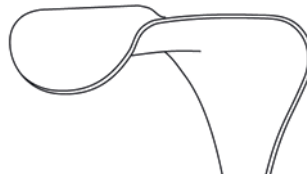

15 x 30 mm  
**AK-1012-06**



15 x 40 mm  
**AK-1012-08**



**Wundhaken  
RetraAKors  
Separadores  
Divaricatori**

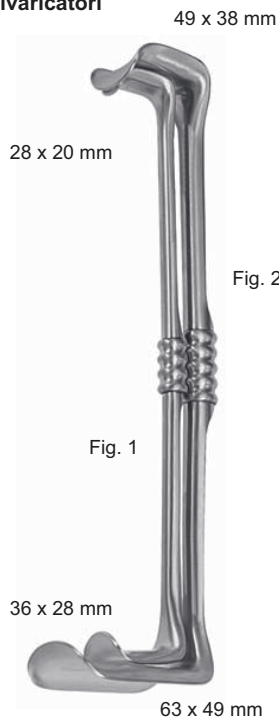
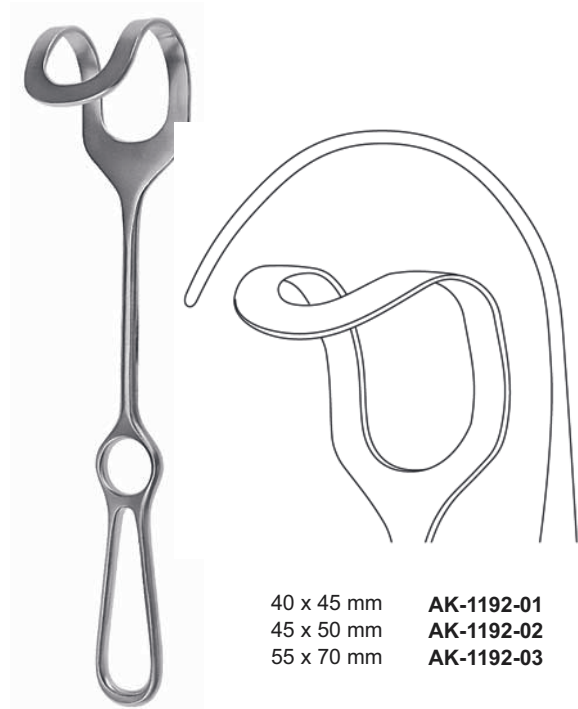

Fig. 2

Fig. 1

Fig. 1+2 28,0 cm, 11" **AK-1200-00**  
Fig. 1 26,0 cm, 10 1/4" **AK-1200-01**  
Fig. 2 28,0 cm, 11" **AK-1200-02**

**RICHARDSON-EAAKMAN**



**MIDDELDORPF**  
25,5 cm, 10"

40 x 45 mm **AK-1192-01**  
45 x 50 mm **AK-1192-02**  
55 x 70 mm **AK-1192-03**



**FRITSCH**  
24,0 cm, 9 1/2"

45 x 40 mm **AK-1240-40**  
45 x 50 mm **AK-1240-50**  
45 x 60 mm **AK-1240-60**  
55 x 75 mm **AK-1240-75**  
65 x 85 mm **AK-1240-85**



**DOYEN**  
25,0 cm, 10"  
**029-230-501**



Wundhaken  
RetraAKors  
Separadores  
Divaricatori



**DOYEN-AKILLE**  
22,0 cm, 8<sup>5</sup>/<sub>16</sub>"

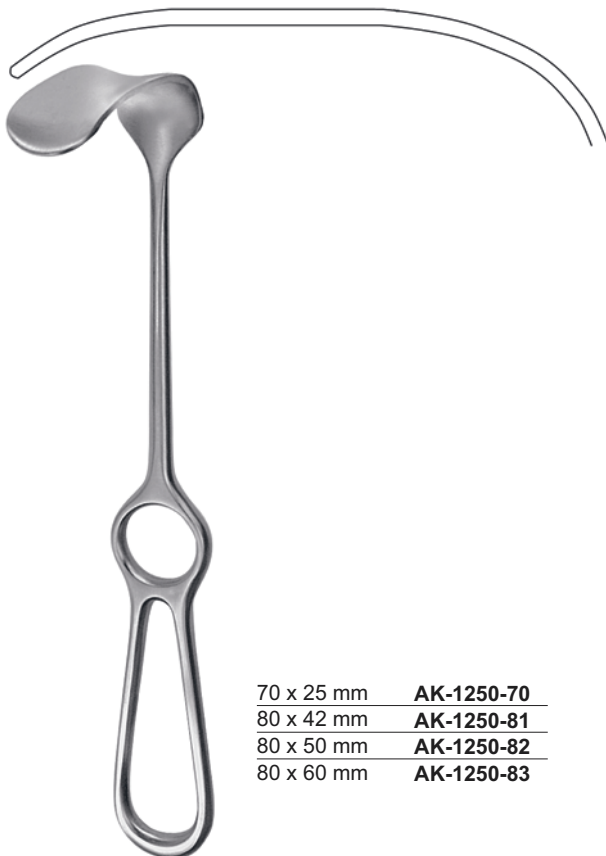
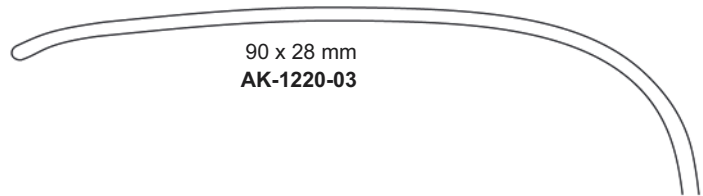
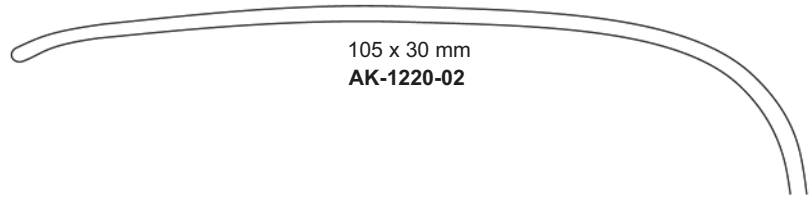
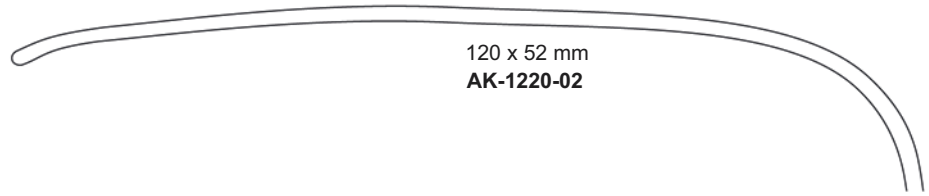

70 x 25 mm	<b>AK-1250-70</b>
80 x 42 mm	<b>AK-1250-81</b>
80 x 50 mm	<b>AK-1250-82</b>
80 x 60 mm	<b>AK-1250-83</b>

**KOCHER**  
25,0 cm, 10"



28 x 6 mm

**LAHEY**  
19,0 cm, 7<sup>1</sup>/<sub>2</sub>"  
**AK-1160-19**





**Wundhaken  
RetraAKors  
Separadores  
Divaricatori**



**LITTLE**  
20,0 cm, 8"  
AK-1164-20



**SIMON**  
28,0 cm, 11"

115 x 22 mm **AK-1260-01**  
115 x 27 mm **AK-1260-02**



**KELLY**  
27,0 cm, 10 1/2"

160 x 38 mm **AK-1280-61**  
160 x 57 mm **AK-1280-62**  
190 x 38 mm **AK-1280-91**  
190 x 57 mm **AK-1280-92**



Wundhaken  
RetraAKors  
Separadores  
Divaricatori



85 x 35 mm **AK-1274-01**  
120 x 50 mm **AK-1274-02**  
155 x 50 mm **AK-1274-03**

**MIKULICZ**  
26,0 cm, 10<sup>1</sup>/<sub>4</sub>"



90 x 50 mm

**MIKULICZ**  
26,0 cm, 10<sup>1</sup>/<sub>4</sub>"  
**AK-1272-90**



70 x 38 mm **AK-1290-38**  
70 x 50 mm **AK-1290-51**

**MORRIS**  
24,5 cm, 9<sup>5</sup>/<sub>8</sub>"



**Wundhaken  
RetraAKors  
Separadores  
Divaricatori**



127 x 40 mm **AK-1500-40**  
127 x 62 mm **AK-1500-62**

**HARRINGTON**  
32,0 cm, 12 1/2"



82 x 22 mm **AK-1390-01**  
108 x 43 mm **AK-1390-02**  
115 x 65 mm **AK-1390-03**

**CORYKKOS**  
24,0 cm, 9 1/2"

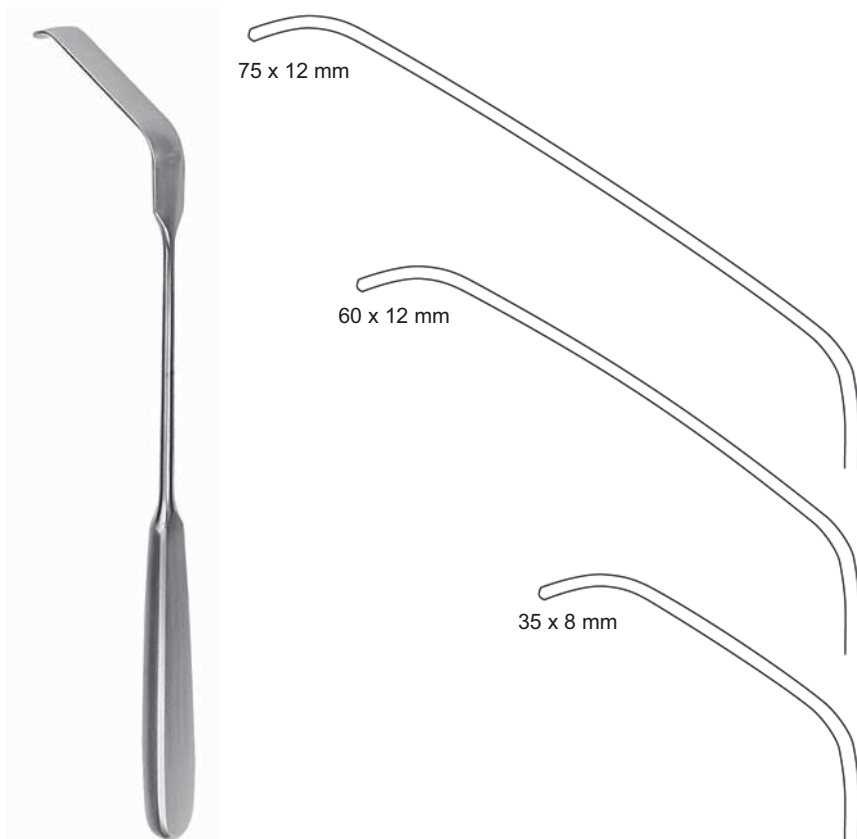

75 x 12 mm

60 x 12 mm

35 x 8 mm

25,0 cm, 9 3/4"  
**AK-1320-25**

26,0 cm, 10 1/4"  
**AK-1320-26**

27,5 cm, 10 3/4"  
**AK-1320-27**

**ZENKER**



**Wundhaken  
RetraAKors  
Separadores  
Divaricatori**



**MEYERDING**  
22,5 cm, 8<sup>3</sup>/<sub>4</sub>"

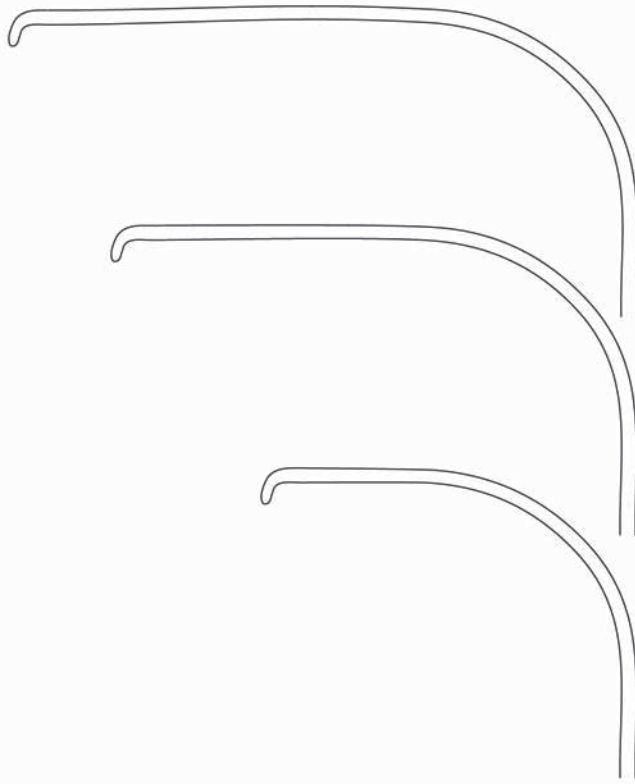

90 x 50 mm  
**AK-1350-50**

75 x 25 mm  
**AK-1350-25**

50 x 16 mm  
**AK-1350-16**



**BRUNNER**  
25,0 cm, 10"

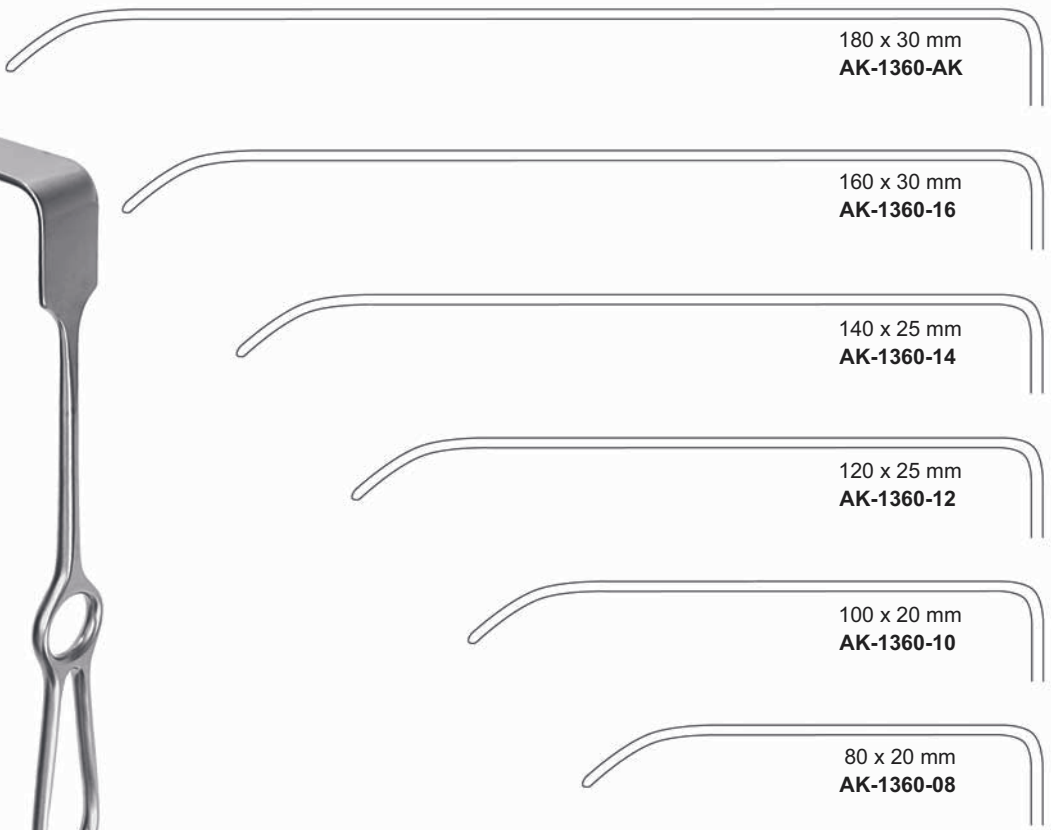

180 x 30 mm  
**AK-1360-AK**

160 x 30 mm  
**AK-1360-16**

140 x 25 mm  
**AK-1360-14**

120 x 25 mm  
**AK-1360-12**

100 x 20 mm  
**AK-1360-10**

80 x 20 mm  
**AK-1360-08**



Wundhaken  
RetraAKors  
Separadores  
Divaricatori

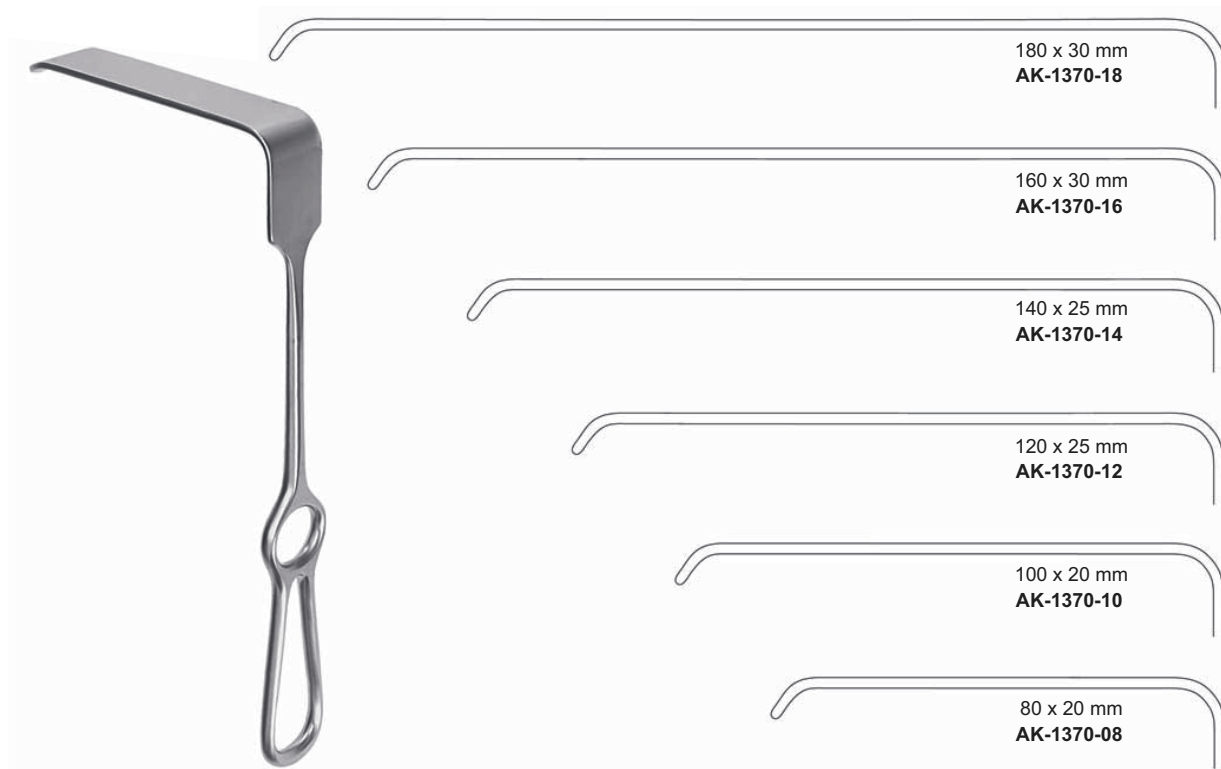

**BRUNNER**  
25,0 cm, 10"



**DEAVER**  
18,0 cm, 7"  
**AK-1602-18**



**DEAVER**  
21,5 cm, 8<sup>1</sup>/<sub>2</sub>"  
**AK-1602-22**

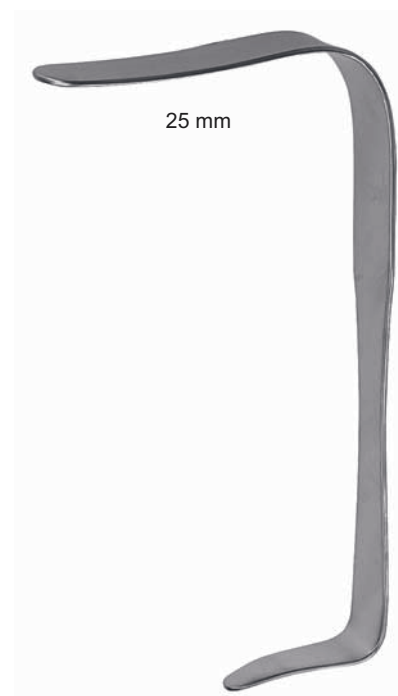

**DEAVER**  
23,0 cm, 9"  
**AK-1602-23**

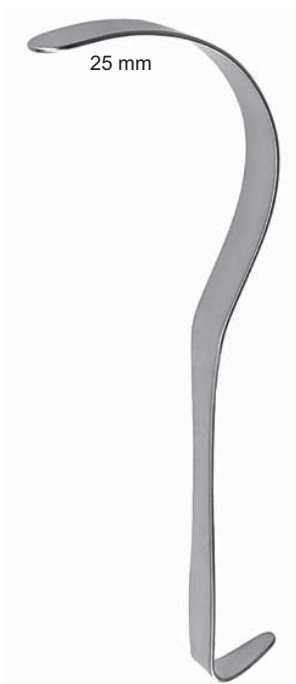

**DEAVER**  
30,0 cm, 11<sup>3</sup>/<sub>4</sub>"  
**AK-1604-30**



**DEAVER**  
33,0 cm, 13"  
**AK-1604-33**



**DEAVER**  
36,0 cm, 14<sup>1</sup>/<sub>8</sub>"  
**AK-1604-36**



**DEAVER**  
30,0 cm, 11<sup>3</sup>/<sub>4</sub>"  
**AK-1610-38**



**DEAVER**  
30,0 cm, 11<sup>3</sup>/<sub>4</sub>"  
**AK-1610-50**



**DEAVER**  
30,0 cm, 11<sup>3</sup>/<sub>4</sub>"  
**AK-1610-75**



Wundhaken  
RetraAKors  
Separadores  
Divaricatori



25 mm	<b>AK-1600-25</b>
38 mm	<b>AK-1600-38</b>
50 mm	<b>AK-1600-50</b>
75 mm	<b>AK-1600-75</b>

**DEAVER GRIP**  
30,0 cm, 11<sup>3</sup>/<sub>4</sub>"



**ALLISON**

40 mm	30,0 cm, 11 <sup>3</sup> / <sub>4</sub> "	<b>AK-1700-30</b>
54 mm	32,0 cm, 12 <sup>1</sup> / <sub>2</sub> "	<b>AK-1700-32</b>



**DAVIDSON**

75 x 50 mm	16,0 cm, 6 <sup>1</sup> / <sub>4</sub> "	<b>AK-1710-50</b>
75 x 90 mm	16,0 cm, 6 <sup>1</sup> / <sub>4</sub> "	<b>AK-1710-90</b>



**AK MARAK**

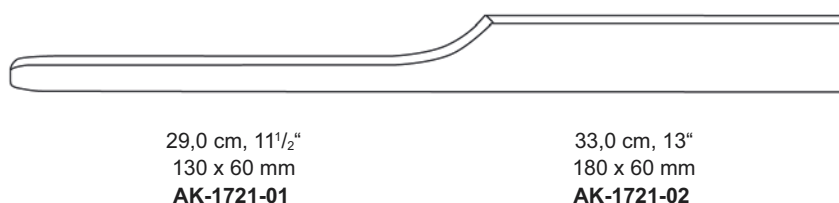
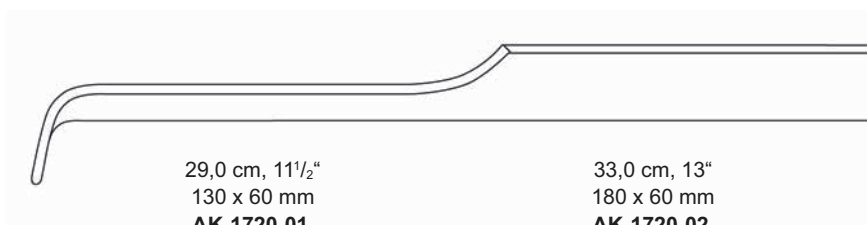



**VASE** INSTRUMENTS  
PREMIUM QUALITY INSTRUMENTS

**Wundspreizer**  
**Self-Retaining RetraAKors**  
**Separadores con retenida automática**  
**Divaricatori autoAKatici**







**Wundspreizer**  
**Self-Retaining RetraAKors**  
**Separadores con retenida automática**  
**Divaricatori autoAKatici**

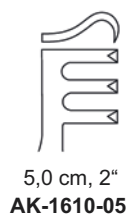

5,0 cm, 2"  
**AK-1610-05**



5,0 cm, 2"  
**AK-1611-05**



**FINSEN**

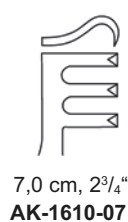

7,0 cm, 2<sup>3</sup>/<sub>4</sub>"  
**AK-1610-07**

scharf  
sharp  
agudos  
acuti



7,0 cm, 2<sup>3</sup>/<sub>4</sub>"  
**AK-1611-07**

AKumpf  
blunt  
romo  
smusso



**JANSEN**  
10,0 cm, 4"



**AK-1630-10**

scharf  
sharp  
agudos  
acuti



**AK-1631-10**

AKumpf  
blunt  
romo  
smusso



**ALM**

scharf      halbscharf      AKumpf  
sharp      semi-sharp      blunt  
agudos      semi-agudos      romo  
acuti      semi-acuti      smusso

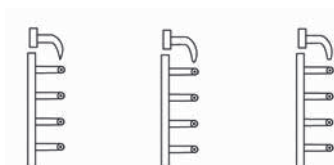

7,0 cm, 2<sup>3</sup>/<sub>4</sub>"    **AK-1620-07**    **AK-1622-07**    **AK-1621-07**  
10,0 cm, 4"    **AK-1620-10**    **AK-1622-10**    **AK-1621-10**



**ALLPOAK**  
9,5 cm, 3<sup>3</sup>/<sub>4</sub>"  
**AK-1626-09**

Wundspreizer  
Self-Retaining RetraAKors  
Separadores con retenida automática  
Divaricatori autoAKatici



**SALP-CONTOUR**  
14,0 cm, 5½"



**AK-1660-14**

scharf  
sharp  
agudos  
acuti



**AK-1661-14**

AKumpf  
blunt  
romo  
smusso



**ADSON-BABY**  
16,0 cm, 6¼"



**AK-1684-16**

scharf  
sharp  
agudos  
acuti



**AK-1685-16**

AKumpf  
blunt  
romo  
smusso



**ANDERSON-ADSON**  
20,0 cm, 8"



**AK-1660-14**

scharf  
sharp  
agudos  
acuti



**AK-1661-14**

AKumpf  
blunt  
romo  
smusso



**ADSON**  
26,5 cm, 10½"



**AK-1684-16**

scharf  
sharp  
agudos  
acuti



**AK-1685-16**

AKumpf  
blunt  
romo  
smusso



**Wundspreizer**  
**Self-Retaining RetraAKors**  
**Separadores con retenida automática**  
**Divaricatori autoAKatici**



**MOLLISON**  
15,5 cm, 6"  
AK-1674-15



scharf  
sharp  
agudos  
acuti



**SCHUHKNECHT**  
12,5 cm, 5"



**AK-1660-14**  
scharf  
sharp  
agudos  
acuti



**AK-1661-14**  
AKumpf  
blunt  
romo  
smusso



**WULLAKEIN**



scharf  
sharp  
agudos  
acuti

AKumpf  
blunt  
romo  
smusso

10,5 cm, 4 <sup>1</sup> / <sub>8</sub> "	<b>AK-1810-10</b>	<b>AK -1811-10</b>
13,0 cm, 5"	<b>AK-1810-13</b>	<b>AK-1811-13</b>
15,0 cm, 6"	<b>AK-1810-15</b>	<b>AK-1811-15</b>
18,0 cm, 7"	<b>AK-1810-18</b>	<b>AK-1811-18</b>



**MAYO-ADAMS**  
16,5 cm, 6<sup>1</sup>/<sub>2</sub>"  
AK-1822-17

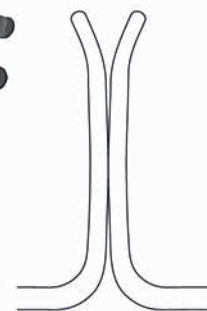

**Wundspreizer**  
**Self-Retaining RetraAKors**  
**Separadores con retenida automática**  
**Divaricatori autoAKatici**



**WEITLANER-LOKTITE**  
10,5 cm, 4 1/8"



**AK-1650-10**  
scharf  
sharp  
agudos  
acuti



**AK-1651-10**  
AKumpf  
blunt  
romo  
smusso



**WEITLANER**  
13,0 cm, 5"



**AK-1670-13**  
scharf  
sharp  
agudos  
acuti



**AK-1671-13**  
AKumpf  
blunt  
romo  
smusso



**WEITLANER**  
16,5 cm, 6 1/2"



**AK-1670-16**  
scharf  
sharp  
agudos  
acuti



**AK-1671-16**  
AKumpf  
blunt  
romo  
smusso



**WEITLANER**  
20,0 cm, 8"



**AK-1670-20**  
scharf  
sharp  
agudos  
acuti



**AK-1671-20**  
AKumpf  
blunt  
romo  
smusso



**Wundspreizer**  
**Self-Retaining RetraAKors**  
**Separadores con retenida automática**  
**Divaricatori autoAKatici**



**WEITLANER**  
24,0 cm, 9 1/2"



**AK-1670-20**

scharf  
sharp  
agudos  
acuti



**AK-1671-20**

AKumpf  
blunt  
romo  
smusso



**PLEAKER**  
13,0 cm, 5"



**AK-1830-13**

scharf  
sharp  
agudos  
acuti



**AK-1831-13**

AKumpf  
blunt  
romo  
smusso



**MILLIGAN**  
13,0 cm, 5"  
**AK-1840-13**

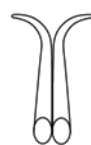
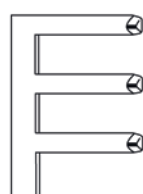

**PLEAKER**  
11,0 cm, 4 3/8"  
**AK-1672-11**

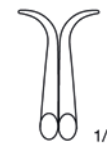

1/1



**PLEAKER**  
11,0 cm, 4 3/8"  
**AK-1673-11**



**WEITLANER-BABY**  
13,0 cm, 5"  
030-1850-13



**GELPI**  
13,5 cm, 5<sup>3</sup>/<sub>8</sub>"  
AK-1202-14



(CONE)



**GELPI**  
19,0 cm, 7<sup>1</sup>/<sub>2</sub>"  
AK-1202-19

**Wundspreizer**  
**Self-Retaining RetraAKors**  
**Separadores con retenida automática**  
**Divaricatori autoAKatici**

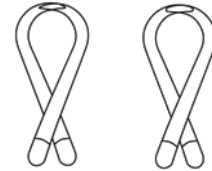

20,0 cm, 8" **AK-1860-20 AK-1861-20**  
26,0 cm, 10<sup>1</sup>/<sub>4</sub>" **AK-1860-26 AK-1861-26**

scharf	AKumpf
sharp	blunt
agudos	romo
acuti	smusso



**GELPI-LOKTITE**  
19,0 cm, 7<sup>1</sup>/<sub>2</sub>"  
AK-1250-19



Wundspreizer  
Self-Retaining RetraAKors  
Separadores con retenida automática  
Divaricatori autoAKatici

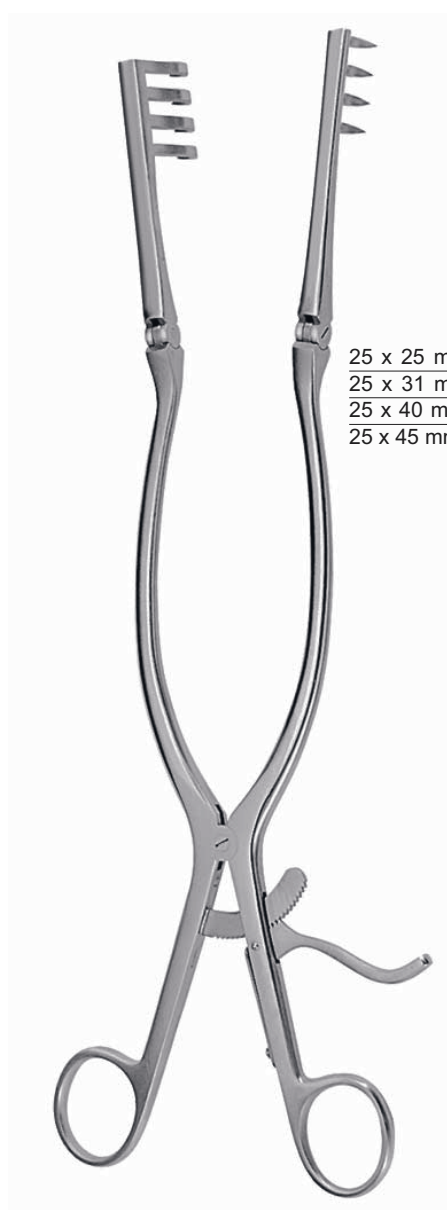

**BECKMANN-ADSON**  
31,0 cm, 12 1/4"

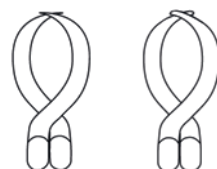

25 x 25 mm	<b>AK-1870-01</b>	<b>AK-1871-01</b>
25 x 31 mm	<b>AK-1870-02</b>	<b>AK-1871-02</b>
25 x 40 mm	<b>AK-1870-03</b>	<b>AK-1871-03</b>
25 x 45 mm	<b>AK-1870-04</b>	<b>AK-1871-04</b>

scharf	AKumpf
sharp	blunt
agudos	romo
acuti	smusso

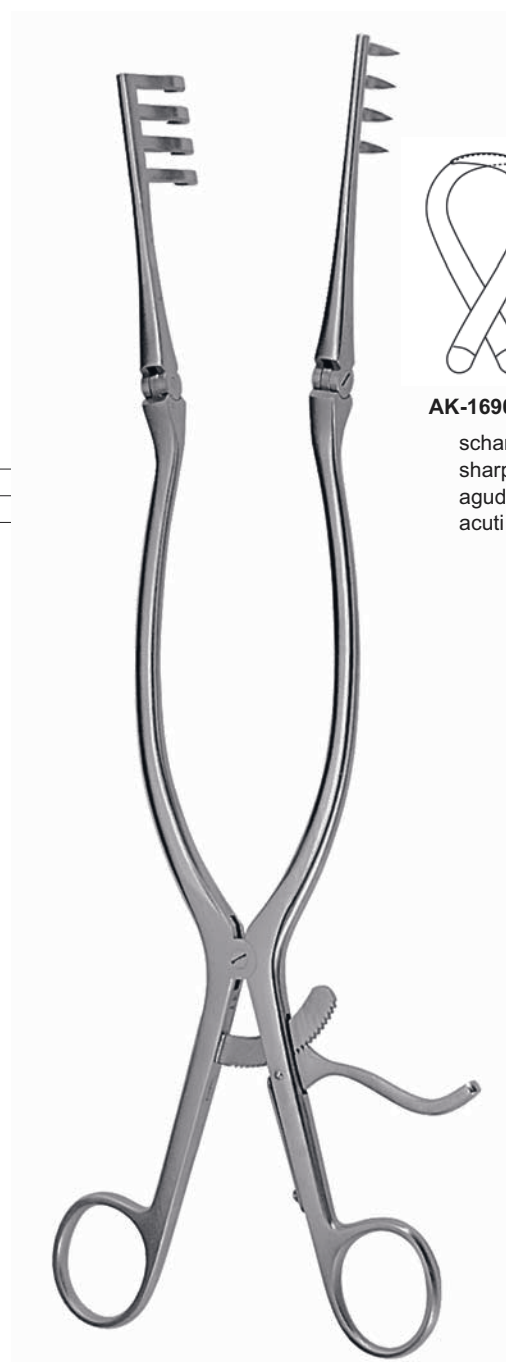

**BECKMANN**  
31,0 cm, 12 1/4"



**AK-1690-31**  
scharf  
sharp  
agudos  
acuti



ADSON  
32,0 cm, 12 1/2"



030-1691-32

AKumpf  
blunt  
romo  
smusso



10,0 cm, 4" AK-1240-10  
14,0 cm, 5 1/2" AK-1240-14

DE BAKEY





**Wundspreizer**  
**Self-Retaining RetraAKors**  
**Separadores con retenida automática**  
**Divaricatori autoAKatici**

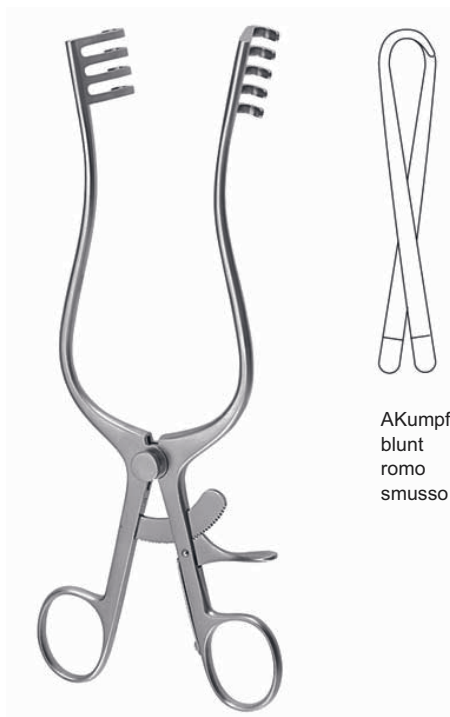

**NORFOLK AND NORWICH**  
22,0 cm, 8<sup>5</sup>/<sub>8</sub>"  
AK-1401-22

AKumpf  
blunt  
romo  
smusso

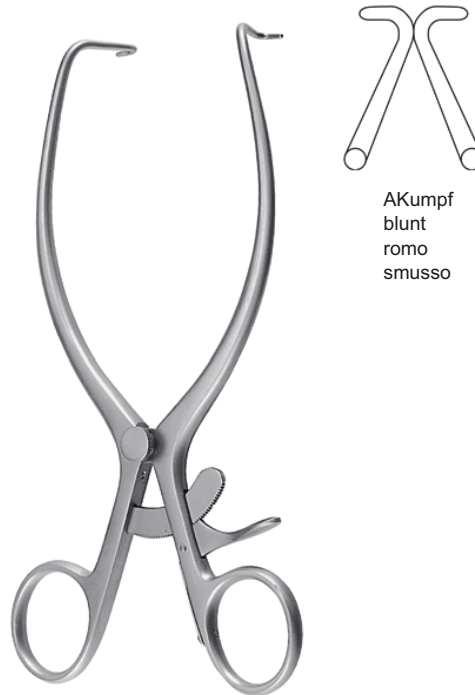

**JACKON BURROWS**  
17,5 cm, 7"  
AK-1411-17

AKumpf  
blunt  
romo  
smusso



**RICHTER**  
17,0 cm, 6<sup>3</sup>/<sub>4</sub>"  
AK-1420-17



**JOLL (FRIEDMAN)**  
15,5 cm, 6"  
AK-1430-15

**Wundspreizer  
Self-Retaining RetraAKors  
Separadores con retenida automática  
Divaricatori autoAKatici**

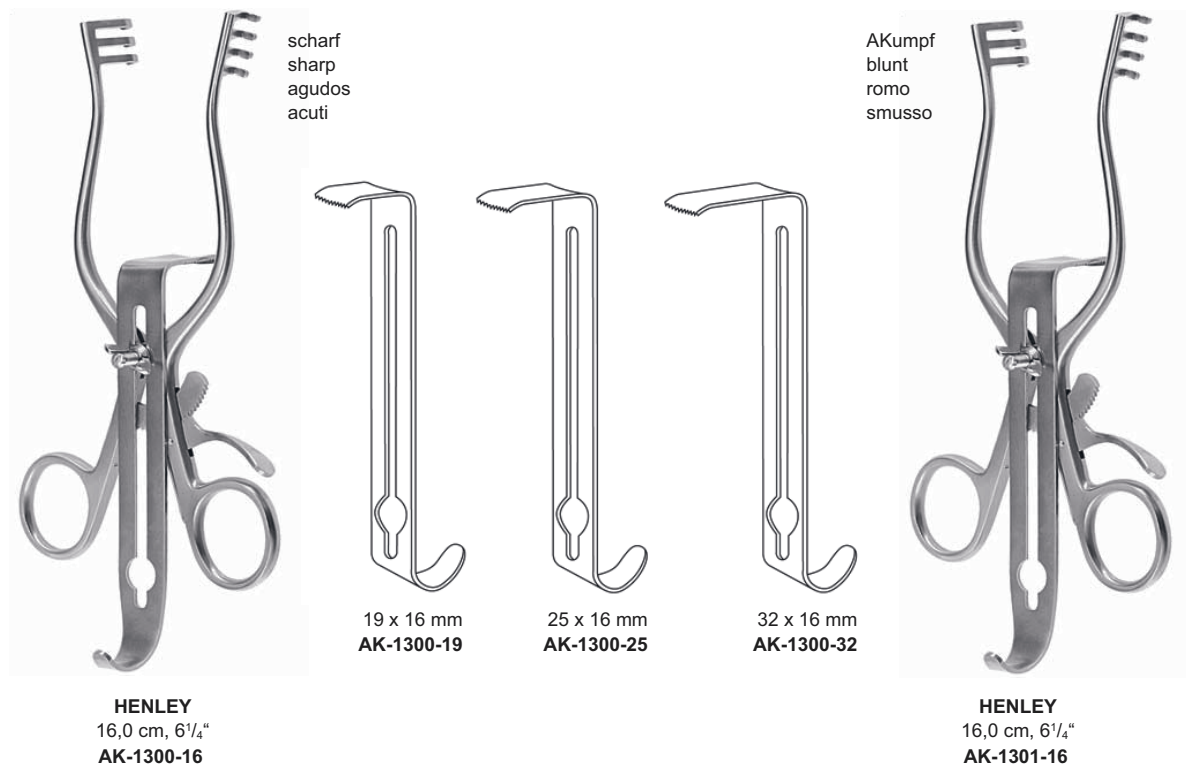

**HENLEY  
AK-1300-00**

komplett, beAKehend aus:

- 1 Sperrer mit Seitenvalven, scharf (070-300-16)
- 1 Mittelvalve 19 x 16 mm (070-300-19)
- 1 Mittelvalve 25 x 16 mm (070-300-25)
- 1 Mittelvalve 32 x 16 mm (070-300-32)

complete, consiAKing of:

- 1 Spreader with lateral valves, sharp (070-300-16)
- 1 Central valve 19 x 16 mm (070-300-19)
- 1 Central valve 25 x 16 mm (070-300-25)
- 1 Central valve 32 x 16 mm (070-300-32)

completo, compueAKo of:

- 1 Separadorcon valvas laterales, agudas (070-300-16)
- 1 Valva central 19 x 16 mm (070-300-19)
- 1 Valva central 25 x 16 mm (070-300-25)
- 1 Valva central 32 x 16 mm (070-300-32)

completo, compoAKo da:

- 1 Divaricatore con valve laterali, acuto (070-300-16)
- 1 Valva centrale 19 x 16 mm (070-300-19)
- 1 Valva centrale 25 x 16 mm (070-300-25)
- 1 Valva centrale 32 x 16 mm (070-300-32)

**HENLEY  
AK-1301-00**

komplett, beAKehend aus:

- 1 Sperrer mit Seitenvalven, AKumpf (070-301-16)
- 1 Mittelvalve 19 x 16 mm (070-300-19)
- 1 Mittelvalve 25 x 16 mm (070-300-25)
- 1 Mittelvalve 32 x 16 mm (070-300-32)

complete, consiAKing of:

- 1 Spreader with lateral valves, blunt (070-301-16)
- 1 Central valve 19 x 16 mm (070-300-19)
- 1 Central valve 25 x 16 mm (070-300-25)
- 1 Central valve 32 x 16 mm (070-300-32)

completo, compueAKo of:

- 1 Separadorcon valvas laterales, romas (070-301-16)
- 1 Valva central 19 x 16 mm (070-300-19)
- 1 Valva central 25 x 16 mm (070-300-25)
- 1 Valva central 32 x 16 mm (070-300-32)

completo, compoAKo da:

- 1 Divaricatore con valve laterali, smusso (070-301-16)
- 1 Valva centrale 19 x 16 mm (070-300-19)
- 1 Valva centrale 25 x 16 mm (070-300-25)
- 1 Valva centrale 32 x 16 mm (070-300-32)



**Wundspreizer, BauchdeckeAKalter**  
**Self-Retaining RetraAKors, Abdominal RetraAKors**  
**Separadores con retenida automática, Separadores abdominales**  
**Divaricatori autoAKatici, Divaricatori addominali**



**MAYO-ADAMS**  
17,0 cm, 6<sup>3</sup>/<sub>4</sub>"  
AK-1320-17



**COLLIN-BABY**  
18,0 cm, 7"  
AK-1330-18

30 x 44 mm  
031-1330-30



23 x 44 mm  
AK-1330-23

Wechselvalven  
Exchangeable blades  
Valvas intergambiabiles  
Valve intercambiabili



**RICARD**  
28,0 cm, 11"  
AK-1310-28



**RICARD**  
30,0 cm, 12"  
AK-1312-30



**Wundspreizer, BauchdeckeAKalter  
Self-Retaining RetraAKors, Abdominal RetraAKors  
Separadores con retenida automática, Separadores abdominales  
Divaricatori autoAKatici, Divaricatori addominali**



**COLLIN**  
23,5 cm, 9<sup>1</sup>/<sub>4</sub>"  
AK-1330-24



**COLLIN**  
23,5 cm, 9<sup>1</sup>/<sub>4</sub>"  
AK-1332-24



**COLLIN**  
23,5 cm, 9<sup>1</sup>/<sub>4</sub>"  
AK-1334-24



**ROBIN-MASSÉ**  
AK-1360-27



**Wundspreizer, BauchdeckeAKalter**  
**Self-Retaining RetraAKors, Abdominal RetraAKors**  
**Separadores con retenida automática, Separadores abdominales**  
**Divaricatori autoAKatici, Divaricatori addominali**

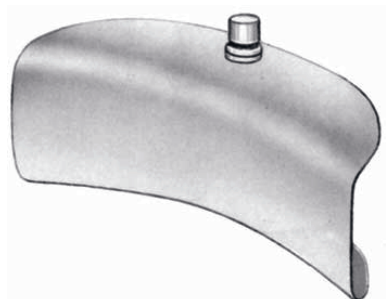

40 x 80 mm **AK-1399-02**  
60 x 80 mm **AK-1399-03**

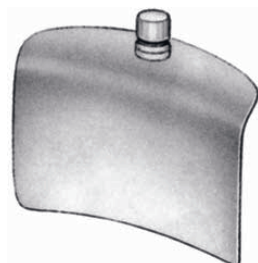

50 x 58 mm **AK-1399-10**  
60 x 80 mm **AK-1399-13**  
72 x 85 mm **AK-1399-14**

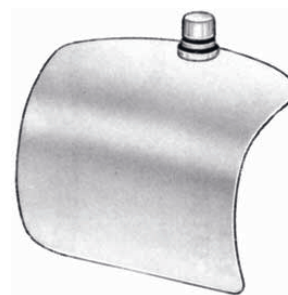

**AK-1399-23**  
60 x 80 mm

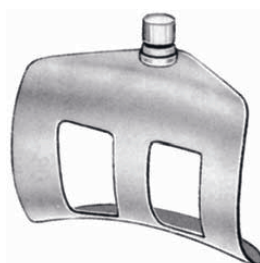

**AK-1399-33**  
60 x 80 mm



58 x 50 mm **AK-1398-01**  
80 x 60 mm **AK-1398-02**  
85 x 72 mm **AK-1398-03**



62 x 38 mm **AK-1398-10**  
80 x 38 mm **AK-1398-11**  
100 x 38 mm **AK-1398-12**  
80 x 38 mm **AK-1398-13**



**COLLIN**  
55 x 55 mm **AK-1331-01**  
55 x 65 mm **AK-1331-02**  
55 x 75 mm **AK-1331-03**



**ROBIN-MASSE**  
40 x 64 mm **AK-1360-01**  
55 x 65 mm **AK-1360-02**  
55 x 75 mm **AK-1360-03**



**RICARD**  
65 x 50 mm **AK-1310-01**  
70 x 55 mm **AK-1310-02**  
90 x 80 mm **AK-1310-03**

BauchdeckeAKalter  
Abdominal RetraAKors  
Separadores abdominales  
Divaricatori addominali



**GOSSET**  
**AK-1400-10**



**GOSSET**  
**AK-1412-14**



**GOSSET**  
**AK-1414-16**



**ABADIE**  
**AK-1450-12**



**Bauchdecke AKalter**  
**Abdominal Retra AKors**  
**Separadores abdominales**  
**Divaricatori addominali**

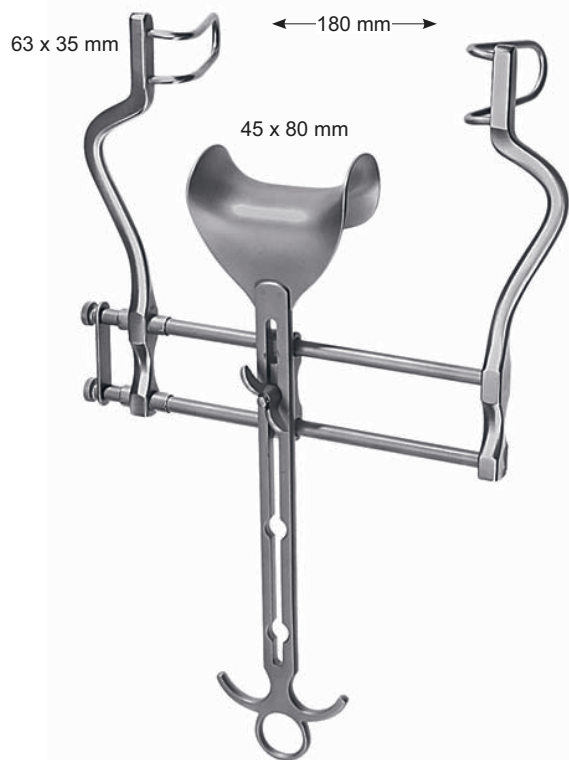

**BALFOUR**  
**AK-1764-18**

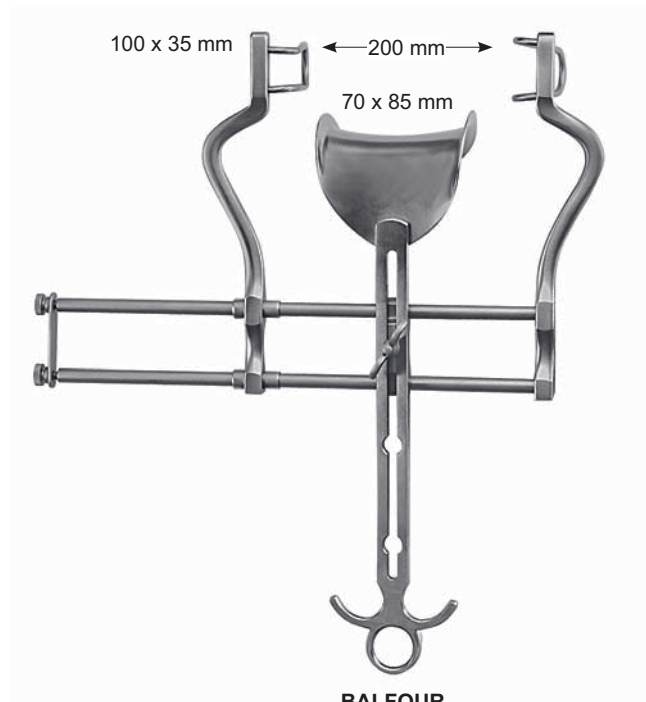

**BALFOUR**  
**AK-1768-20**

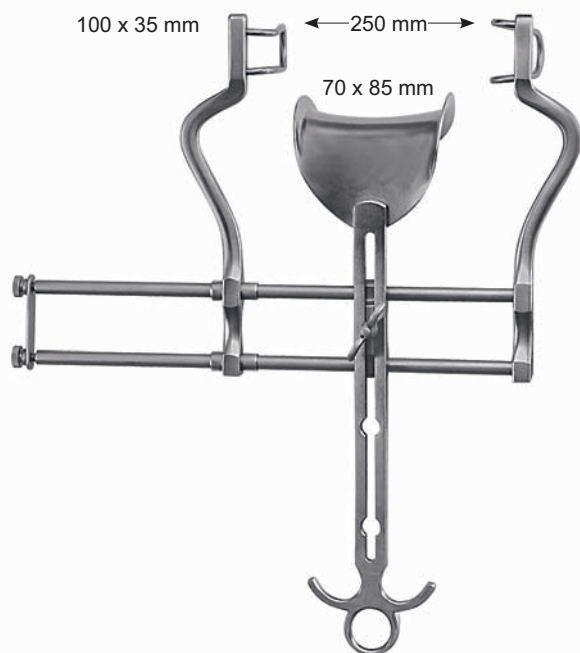

**BALFOUR**  
**AK-1768-25**

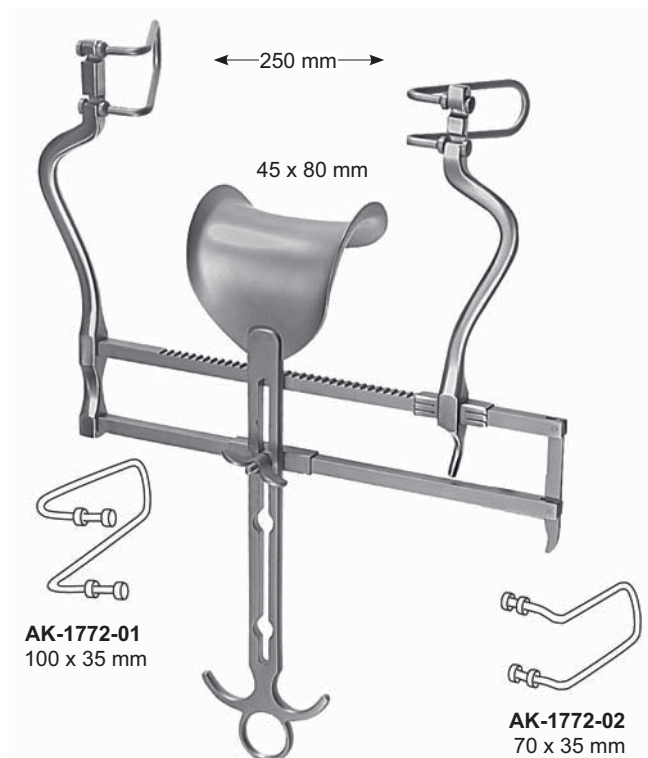

**BALFOUR US-TYPE**  
**AK-1772-25**

BauchdeckeAKalter  
Abdominal RetraAKors  
Separadores abdominales  
Divaricatori addominali

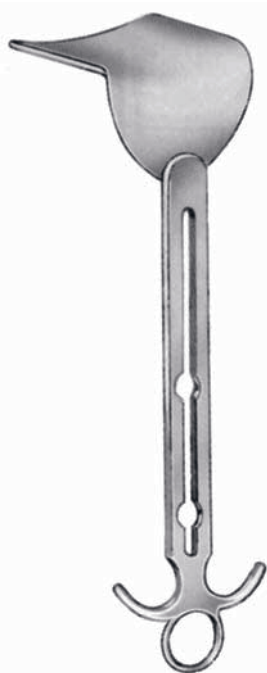

**BALFOUR**  
100 x 70 mm  
AK-1799-70

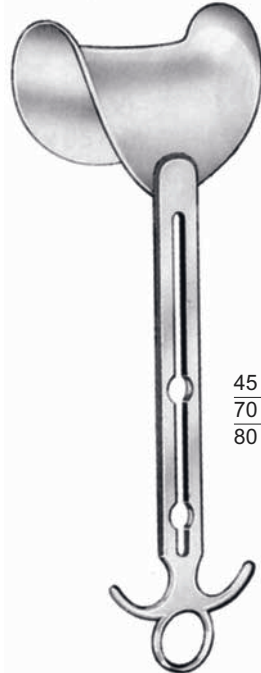

**BALFOUR**

45 x 80 mm **AK-1798-01**  
70 x 85 mm **AK-1798-02**  
80 x 90 mm **AK-1798-03**

27 x 27 mm

← 90 mm →

24 x 20 mm  
**AK-1760-24**

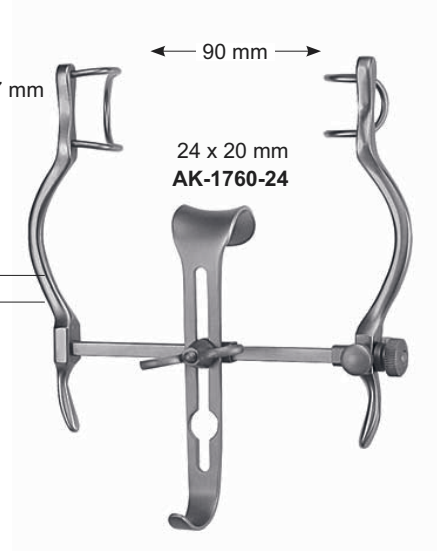

**BALFOUR**  
AK-1760-09



**BERKELEY**  
AK-1610-00

35 x 60 mm  
031-1610-01

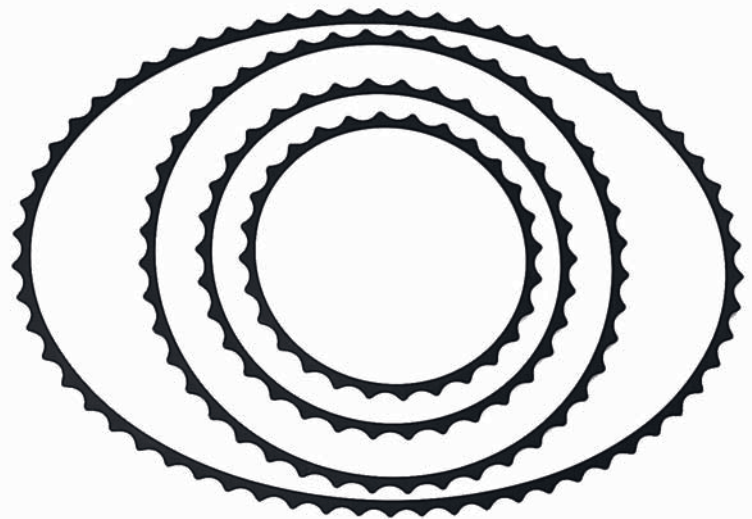

**TUAKER-WAAKICK**  
modifizieAK

Ø 180 mm, 7" **AK-1850-18**  
Ø 230 mm, 9" **AK-1850-23**  
Ø 305 mm, 12" **AK-1850-30**  
455 x 330 mm **AK-1850-45**





**Bauchdecke AKalter**  
**Abdominal Retra AKors**  
**Separadores abdominales**  
**Divaricatori addominali**

gescAKärzt, black fi nish, negra, nera



**AK-1859-01**  
13 mm



**AK-1859-02**  
51 x 38 mm



**AK-1859-03**  
70 x 60 mm



**AK-1859-04**  
89 x 60 mm



**AK-1859-05**  
114 x 60 mm

**TUAKER-WAAKICK**  
**modifizieAK**

gescAKärzt, black fi nish, negra, nera



**AK-1859-06**  
19 x 76 mm



**AK-1859-07**  
38 x 102 mm



**AK-1859-08**  
57 x 89 mm



**AK-1859-09**  
57 x 114 mm



**BauchdeckeAKalter**  
**Abdominal RetraAKors**  
**Separadores abdominales**  
**Divaricatori addominali**

**AK-1860-11**  
40 x 30 mm

**AK-1860-22**  
40 x 40 mm

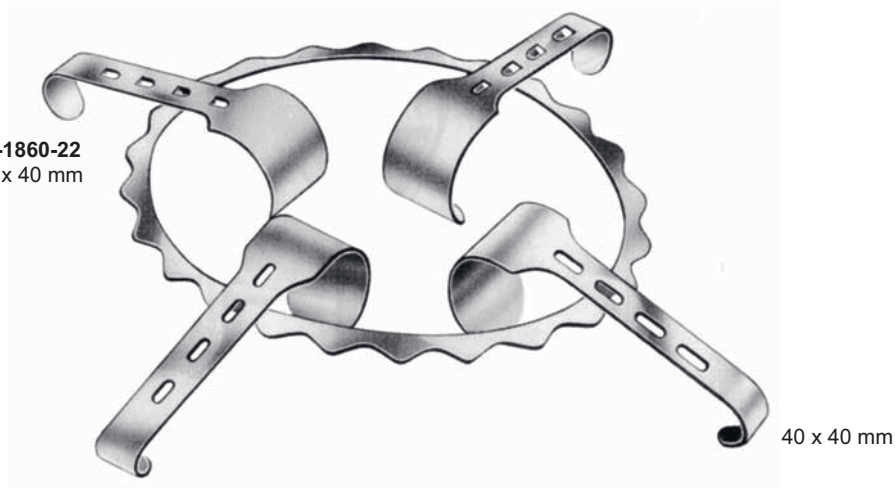

40 x 30 mm

40 x 40 mm

**AK-1860-01**  
**255 x 180 mm**  
Rahmen allein  
frame only  
cuadro suelto  
solo telaio

**DENNIS BROWN**  
**255 x 180 mm**  
**AK-1860-00**  
komplett complete  
completo  
completo

**AK-1870-11**  
80 x 45 mm

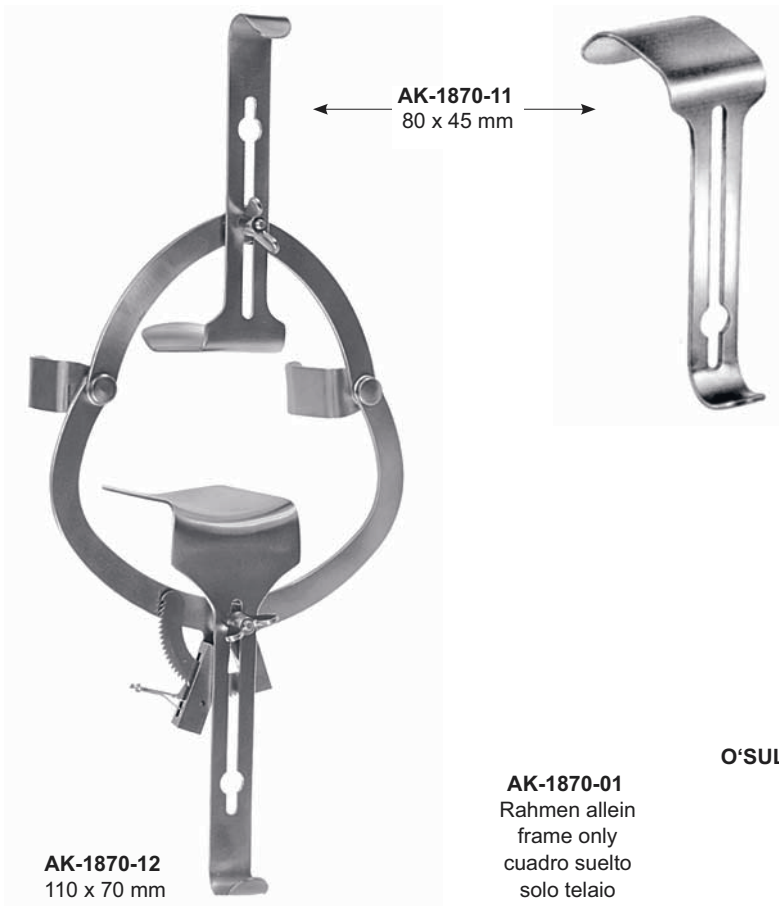

**AK-1870-12**  
110 x 70 mm

**AK-1870-01**  
Rahmen allein  
frame only  
cuadro suelto  
solo telaio

**O'SULLIVAN-O'CONNOR**  
**AK-1870-00**  
komplett  
complete  
completo  
completo



**Bauchdecke AKaltes**  
**Abdominal Retra AKors**  
**Separadores abdominales**  
**Divaricatori addominali**

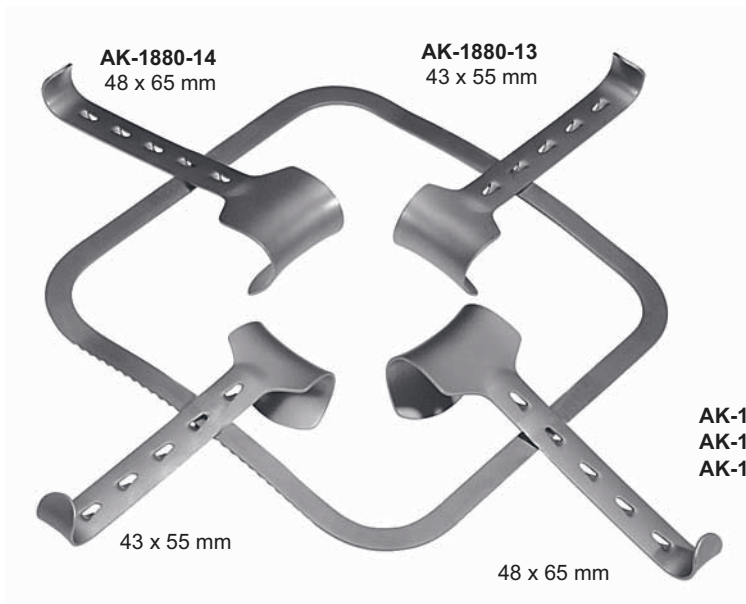

**AK-1870-01** 250 x 250 mm  
**AK-1870-01** 300 x 320 mm  
**AK-1870-01** 300 x 380 mm  
Rahmen allein  
frame only  
cuadro suelto  
solo telaio

**KIRSCHNER**  
**AK-1880-00**  
komplett  
complete  
completo  
completo  
1 x 074-880-01  
2 x 074-880-13  
2 x 074-880-14



**AK-1882-01**  
255 x 255 mm  
zusammenlegbarer Rahmen, allein  
folding frame, only  
cuadro plegable, suelto  
telaio pieghevole, solo

**KIRSCHNER**  
**AK-1882-00**  
komplett  
complete  
completo  
completo  
1 x 074-882-01  
2 x 074-880-13  
2 x 074-880-14



43 x 55 mm **AK-1880-13**  
48 x 65 mm **AK-1880-14**  
80 x 90 mm **AK-1880-15**  
90 x 65 mm **AK-1880-16**  
98 x 95 mm **AK-1880-17**

**KIRSCHNER**

Bauchdecke AKalter  
Abdominal Retra AKors  
Separadores abdominales  
Divaricatori addominali



**KIRSCHNER**  
60 x 82 mm  
**AK-1880-11**



**KIRSCHNER-BALFOUR**  
83 x 82 mm  
**AK-1880-12**



**KIRSCHNER**  
98 x 51 mm **AK-1880-20**  
105 x 38 mm **AK-1880-21**

**AK-1880-14**  
48 x 65 mm

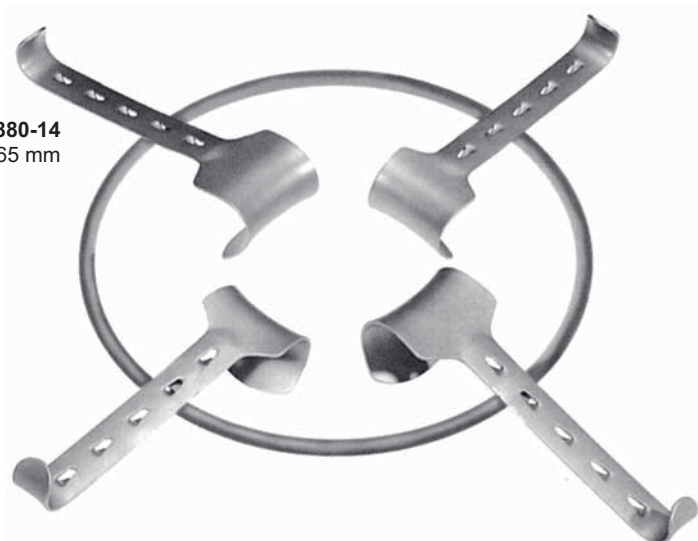

**KIRSCHNER, oval**  
**AK-1884-00**  
komplett, complete, completo, completo  
1 x 074-884-01  
3 x 074-880-14  
1 x 074-880-15  
1 x 074-880-20  
1 x 074-880-21

**AK-1890-01**  
300 x 240 mm  
Rahmen allein  
frame only  
cuadro suelto  
solo telaio

**AK-1880-15**  
80 x 90 mm



**KIRSCHNER**  
98 x 51 mm **AK-1880-20**  
105 x 38 mm **AK-1880-21**



**BauchdeckeAKalter**  
**Abdominal RetraAKors**  
**Separadores abdominales**  
**Divaricatori addominali**

**AK-1890-13**  
76 x 98 mm

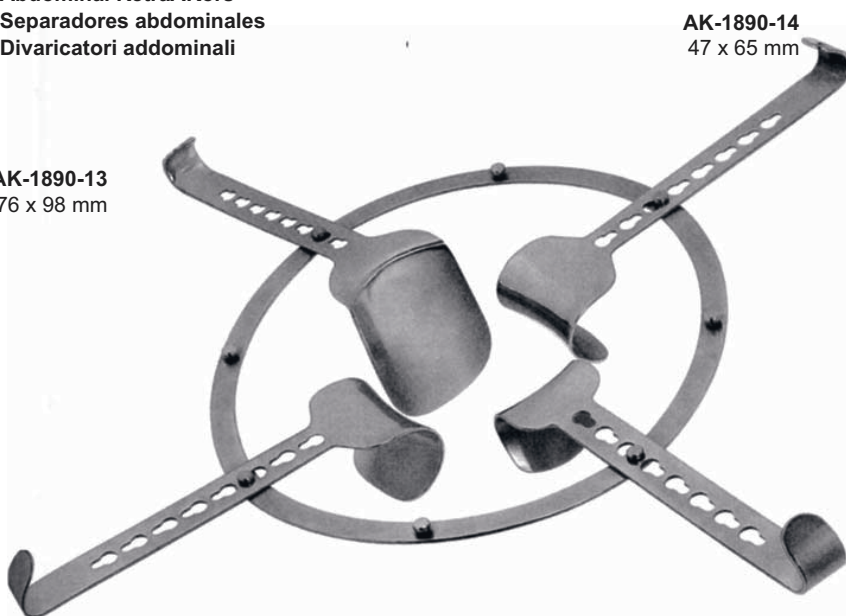

**AK-1890-14**  
47 x 65 mm



**AK-1890-11**  
98 x 52 mm

**AK-1890-12**  
105 x 35 mm

47 x 65 mm

**AK-1890-01**  
275 x 250 mm  
Rahmen allein  
frame only  
cuadro suelto  
solo telaio

**AK-1890-15**  
50 x 54 mm

**AK-1900-13**  
38 x 60 mm

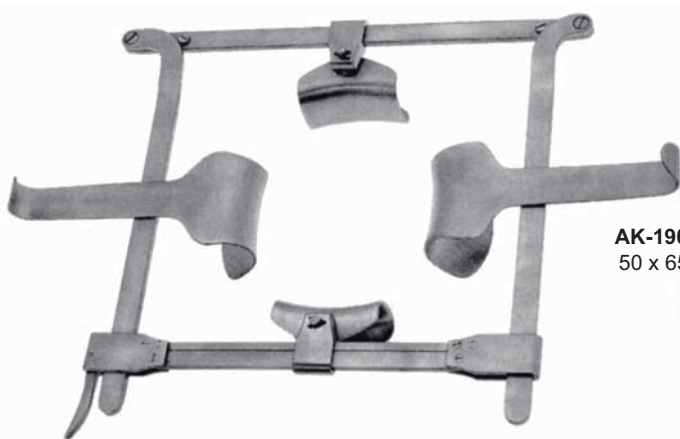

**AK-1900-11**  
50 x 65 mm

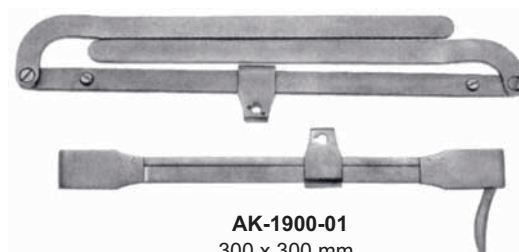

**AK-1900-01**  
300 x 300 mm  
zusammenlegbarer Rahmen, allein  
folding frame, only  
cuadro plegable, suelto  
telaio pieghevole, solo

**FRANZ**  
**AK-1900-00**  
komplett  
complete  
completo  
completo  
1 x 031-1900-01  
2 x 031-1900-11  
2 x 031-1900-13



38 x 60 mm **AK-1900-13**  
45 x 80 mm **AK-1900-14**



50 x 65 mm **AK-1900-11**  
60 x 85 mm **AK-1900-12**



**BauchdeckeAKalter**  
**Abdominal RetraAKors**  
**Separadores abdominales**  
**Divaricatori addominali**



95 x 60 mm **AK-1910-11**  
105 x 65 mm **AK-1910-12**  
115 x 65 mm **AK-1910-13**  
125 x 65 mm **AK-1910-14**

**DOYEN**  
28,0 cm, 11"

für / for / para / per  
031-1910-11  
031-1910-14



Kette mit Gewicht  
Chain with weight  
Cadena con pesa  
Catena con peso

**AK-1915-30**  
78,5 cm, 31"



53,0 cm, 21"

66,0 cm, 26"

BefeAKigungsgeAKell  
Mounting frame  
BaAKidor para la fi jación  
Telaio di suppoAKo per il fi ssaggio

**ROCHARD**  
**031-1920-01**



53,0 cm, 21"

66,0 cm, 26"

BefeAKigungsgeAKell  
Mounting frame  
BaAKidor para la fi jación  
Telaio di suppoAKo per il fi ssaggio

**ROCHARD**  
**AK-1920-02**

95 x 48 mm **AK-1920-10**  
105 x 48 mm **AK-1920-12**  
115 x 48 mm **AK-1920-12**  
125 x 48 mm **AK-1920-13**  
155 x 48 mm **AK-1920-16**



**ROCHARD**  
28,0 cm, 11"  
**AK-1920-20**

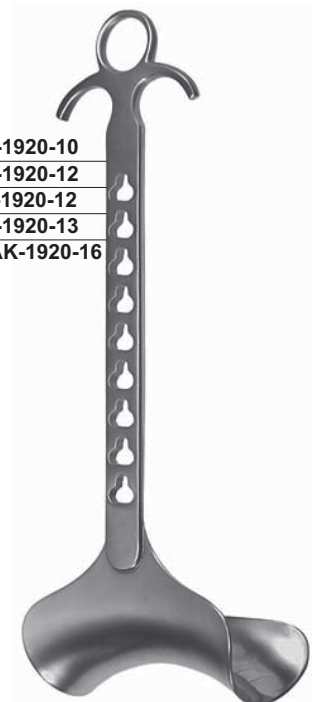

**ROCHARD**  
28,0 cm, 11"



**Bauchspatel**  
**Abdominal Spatulas**  
**Espátulas abdominales**  
**Spatole addominali**



biegsam  
malleable  
maleable  
malleabile

- 200 x 6 mm **AK-1210-06**
- 200 x 12 mm **AK-1210-12**
- 200 x 17 mm **AK-1210-17**
- 200 x 20 mm **AK-1210-20**
- 200 x 25 mm **AK-1210-25**

**RIBBON**



biegsam  
malleable  
maleable  
malleabile

- 330 x 13 mm **AK-1170-13**
- 330 x 25 mm **AK-1170-25**
- 330 x 32 mm **AK-1170-32**
- 330 x 40 mm **AK-1170-40**
- 330 x 50 mm **AK-1170-50**

**RIBBON**



biegsam  
malleable  
maleable  
malleabile

- 280 x 25/30 mm **AK-1200-01**
- 300 x 37/45 mm **AK-1200-02**
- 300 x 40/50 mm **AK-1200-03**

**RIBBON**



biegsam  
malleable  
maleable  
malleabile

**TUFFIER**  
200 x 25/17 mm  
**AK-1220-20**



**REVERDIN**  
280 x 45/60 mm  
**AK-1230-28**

Rippensperrer  
Rib Spreaders  
Separadores coAKales  
Divaricatori coAKali



roAKfrei  
AKainless AKeel  
inox  
arrugginimento

a	b	c	
18 mm	20 mm	75 mm	<b>AK-1100-01</b>

**FINOCCHIETTO-BABY**

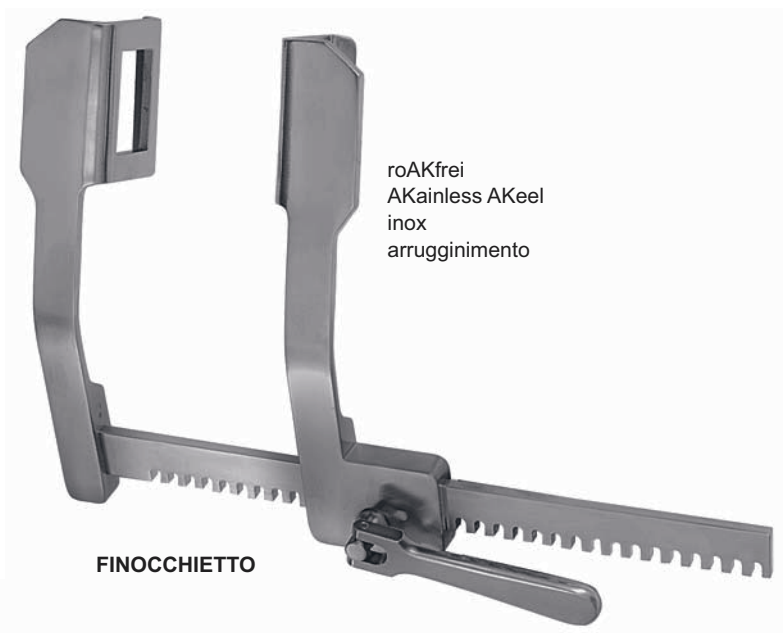

roAKfrei  
AKainless AKeel  
inox  
arrugginimento

a	b	c	
40 mm	40 mm	165 mm	<b>AK-1100-02</b>
45 mm	65 mm	200 mm	<b>AK-1100-03</b>
70 mm	65 mm	250 mm	<b>AK-1100-04</b>

**FINOCCHIETTO**



roAKfrei  
AKainless AKeel  
inox  
arrugginimento

a	b	c	
50 mm	45 mm	165 mm	<b>AK-1150-01</b>

**TUFFIER**





**VASE** INSTRUMENTS  
PREMIUM QUALITY INSTRUMENTS

**Sonden, Trokare**  
**Probes, Trocars**  
**Sondas, Trócares**  
**Sonde, TrequaAKi**





Sonden  
Probes  
Sondas  
Sonde

Ø 2,0 mm



Ø 1,0 mm    Ø 2,0 mm

11,5 cm, 4 1/2"	<b>AK-1000-11</b>	<b>AK-1004-11</b>
13,0 cm, 5"	<b>AK-1000-13</b>	<b>AK-1004-13</b>
14,5 cm, 5 3/4"	<b>AK-1000-14</b>	<b>AK-1004-14</b>
16,0 cm, 6 1/4"	<b>AK-1000-16</b>	<b>AK-004-15</b>
18,0 cm, 7"	<b>AK-1000-18</b>	<b>AK-1004-18</b>
20,0 cm, 8"	<b>AK-1000-20</b>	<b>AK-1004-20</b>



11,5 cm, 4 1/2"	<b>AK-1013-11</b>
13,0 cm, 5"	<b>AK-1013-13</b>
14,5 cm, 5 3/4"	<b>AK-1013-14</b>
16,0 cm, 6 1/4"	<b>AK-1013-16</b>
18,0 cm, 7"	<b>AK-1013-18</b>
20,0 cm, 8"	<b>AK-1013-20</b>

Ø 1,0 mm



Silber  
Silver  
Plata  
Argento

**AKACKE**  
10,5 cm, 4 1/8"  
**AK-1033-10**



MyAKenblattsonden  
MyAKle leaf probes  
Sondas para miAKo  
Sonde a foglia di miAKo

11,5 cm, 4 1/2"	<b>AK-1027-11</b>
13,0 cm, 5"	<b>AK-1027-13</b>
14,5 cm, 5 3/4"	<b>AK-1027-14</b>
16,0 cm, 6 1/4"	<b>AK-1027-16</b>
18,0 cm, 7"	<b>AK-1027-18</b>
20,0 cm, 8"	<b>AK-1027-20</b>



**NÉLATON**  
16,0 cm, 6 1/4"  
**AK-1120-16**



**DOYEN**  
14,5 cm, 5 3/4"  
**AK-1117-14**



**BRODIE**  
20,0 cm, 8"  
**AK-1126-20**

Ø 3,5 mm



Ø 3,5 mm



11,5 cm, 4 1/2" **AK-1110-11**  
13,0 cm, 5" **AK-1110-13**  
14,5 cm, 5 3/4" **AK-1110-14**  
16,0 cm, 6 1/4" **AK-1110-16**  
18,0 cm, 7" **AK-1110-18**  
20,0 cm, 8" **AK-1110-20**

Ø 3,3 mm



13,0 cm, 5" **AK-1122-13**  
14,5 cm, 5 3/4" **AK-1122-14**  
16,0 cm, 6 1/4" **AK-1122-16**  
18,0 cm, 7" **AK-1122-18**



**LOCKHAAK-MUMMERY**  
16,5 cm, 6 1/2"  
**AK-1130-01**



**LOCKHAAK-MUMMERY**  
16,5 cm, 6 1/2"  
**AK-1130-02**

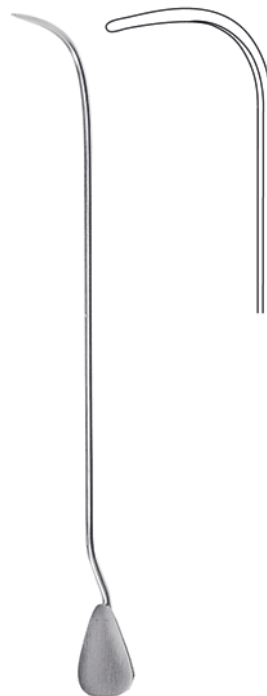

**LOCKHAAK-MUMMERY**  
16,5 cm, 6 1/2"  
**AK-1130-03**



**LOCKHAAK-MUMMERY**  
16,5 cm, 6 1/2"  
**AK-1130-04**



Watteträger  
Cotton Applicators  
PoAKa-algodones  
PoAKa-cotone



**FEIN**  
28,0 cm, 11"  
AK-1264-28



**UKERMANN**  
16,0 cm, 6 1/4"  
AK-1260-16



**JOBSON-HOAKE**  
18,0 cm, 7"  
AK-1262-18



12,0 cm, 4 3/4" **AK-1271-12** Ø 0,9 mm  
14,0 cm, 5 3/4" **AK-1271-14** Ø 0,9 mm  
16,5 cm, 6 1/4" **AK-1271-16** Ø 1,1 mm  
18,0 cm, 7" **AK-1271-18** Ø 1,2 mm

**FARRELL**  
(LATHBURY)



12,0 cm, 4 3/4" **AK-1270-12** Ø 0,9 mm  
14,0 cm, 5 3/4" **AK-1270-14** Ø 0,9 mm  
16,5 cm, 6 1/4" **AK-1270-16** Ø 1,1 mm  
18,0 cm, 7" **AK-1270-18** Ø 1,2 mm

**FARRELL**

**Krampfader-BeAKeck**  
**Varicose Vein Probe Set**  
**Juego para várices**  
**AAKuccio per varici**



**AK-1150-01**  
Metalletui  
Metal case  
EAKuche de metal  
Scatola in metallo

135 x 100 x 25 mm

**NABATOFF**  
**AK-1150-00**  
komplett  
complete  
completo  
completo



**AK-1150-21**  
Zugseil  
Cable  
Cable  
Funne

**AK-1150-22**  
KunAKAKoff-Sondenspitze  
PlaAKic probe tip  
Extremidad de sonda de pláAKico  
Punta in materia plaAKica



Ø 3,0 mm  
**AK-1150-03**



Ø 6,0 mm  
**AK-1150-06**



Ø 9,0 mm  
**AK-11150-09**



Ø 12,0 mm  
**AK-1150-12**

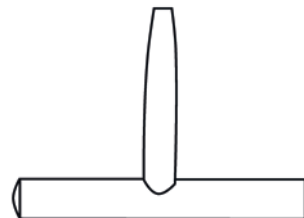

**AK-1150-20**  
Handgriff  
Handle  
Mango  
Manico



Trokare  
Trocars  
Trócares  
TrequaAKi



**AKANDARD**  
11,0 cm, 4<sup>3</sup>/<sub>8</sub>"

- Ø 3,0 mm **AK-1110-30**
- Ø 3,5 mm **AK-1110-35**
- Ø 4,0 mm **AK-1110-40**
- Ø 4,5 mm **AK-1110-45**
- Ø 5,0 mm **AK-1110-50**
- Ø 5,5 mm **AK-1110-55**
- Ø 6,0 mm **AK-1110-60**



**AKANDARD**  
12,0 cm, 4<sup>3</sup>/<sub>4</sub>"

- Ø 3,0 mm **AK-1112-30**
- Ø 3,5 mm **AK-1112-35**
- Ø 4,0 mm **AK-1112-40**
- Ø 4,5 mm **AK-1112-45**
- Ø 5,0 mm **AK-1112-50**
- Ø 5,5 mm **AK-1112-55**
- Ø 6,0 mm **AK-1112-60**



**AKANDARD**  
12,0 cm, 4<sup>3</sup>/<sub>4</sub>"

- Ø 3,0 mm **AK-1114-30**
- Ø 3,5 mm **AK-1114-35**
- Ø 4,0 mm **AK-1114-40**
- Ø 4,5 mm **AK-1114-45**
- Ø 5,0 mm **AK-1114-50**
- Ø 5,5 mm **AK-1114-55**
- Ø 6,0 mm **AK-1114-60**



**HURWITZ**

- Ø 7,3 mm **AK-1118-07**
- Ø 8,7 mm **AK-1118-09**
- Ø 12,0 mm **AK-1118-12**



**UNIVERSAL**  
**AK-1100-03**

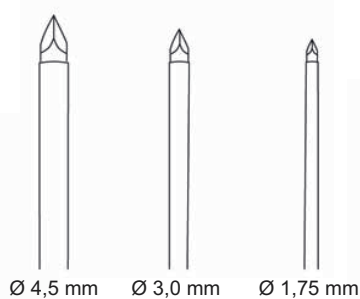

**UNIVERSAL**  
**AK-1100-04**

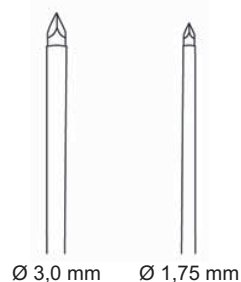
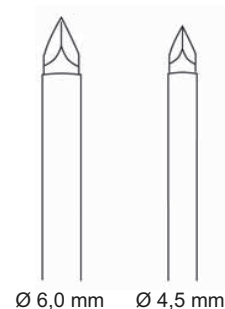



Trokare  
Trocars  
Trócares  
TrequaAKi

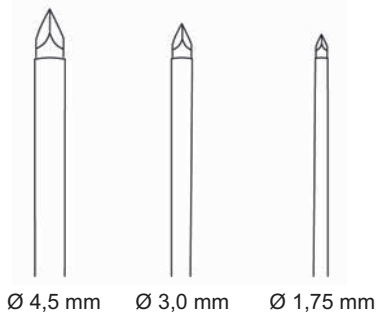

Ø 4,5 mm    Ø 3,0 mm    Ø 1,75 mm

**UNIVERSAL**  
**AK-1102-03**

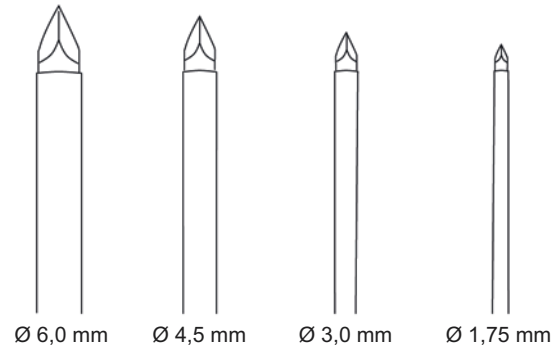

Ø 6,0 mm    Ø 4,5 mm    Ø 3,0 mm    Ø 1,75 mm

**UNIVERSAL**  
**AK-1102-04**

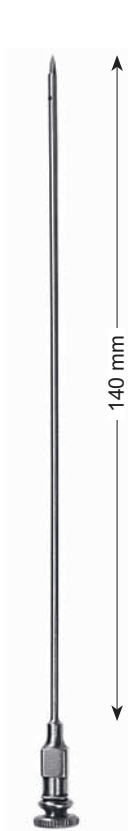

140 mm

**LANDAU**  
Ø 2,0 mm  
**AK-1160-16**



**LANDAU**  
Ø 2,0 mm  
**AK-1161-16**



**DAVIDSON**  
Ø 6,0 mm  
**AK-1164-18**



**BUELAU**  
Ø 8,0 mm  
**AK-1124-24**



Trokare  
Trocars  
Trócares  
TrequaAKi



Ø 2,0 mm **AK-1130-20**  
Ø 2,5 mm **AK-1130-25**  
Ø 3,0 mm **AK-1130-30**

**LERMOYEZ**



Ø 6,0 mm **AK-1128-06**  
Ø 8,0 mm **AK-1128-08**

**CAMPBELL**  
16,0 cm, 6 1/4"



80 mm  
Ø 7,5 mm **AK-1120-01**  
Ø 9,0 mm **AK-1120-02**  
Ø 10,5 mm **AK-1120-03**  
Ø 12,0 mm **AK-1120-04**

**NELSON**  
21,0 cm, 8 1/2"

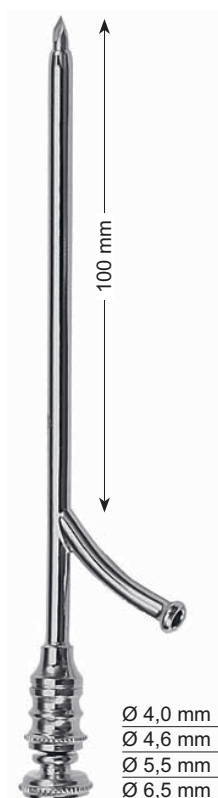

100 mm

Ø 4,0 mm **AK-1140-01**  
Ø 4,6 mm **AK-1140-02**  
Ø 5,5 mm **AK-1140-03**  
Ø 6,5 mm **AK-1140-04**

**OCHSNER**  
14,0 cm, 5 1/2"



Record Konus  
Record cone

Ø 3,0 mm **AK-1180-30**  
Ø 4,0 mm **AK-1180-40**  
Ø 5,0 mm **AK-1180-50**

**PIERCE**  
16,0 cm, 6 1/4"



Ø 2,25 mm

**COAKLEY**  
14,0 cm, 5 1/2"  
**AK-1190-14**





Ø 4,0 mm

**KRAUSE**  
16,0 cm, 6 1/4"

**LICHTWITZ**  
Kieferhöhlentrokare  
Antrum trocars  
Trócares para el seno maxilar  
TrequaAKi per puntura del seno mascellare

Ø 1,8 mm

Ø 3,0 mm **AK-1184-30**  
Ø 4,0 mm **AK-1184-40**  
Ø 5,0 mm **AK-1184-50**  
Ø 5,5 mm **AK-1184-55**



**LICHTWITZ**  
20,0 cm, 8"  
**AK-1170-00**

**Trokare, Saugrohre**  
**Trocars, SuAKion Tubes**  
**Trócares, Tubos para aspiración**  
**TrequaAKi, Tubi aspirazione**

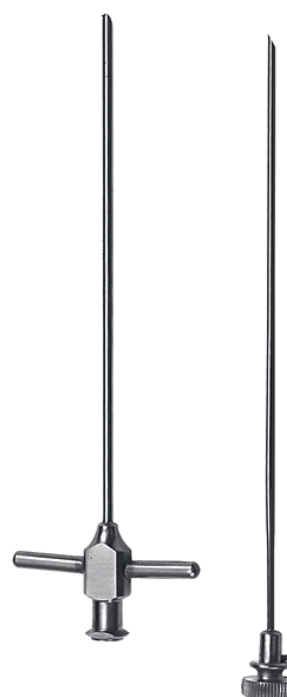

**LICHTWITZ**  
11,0 cm, 4 1/2"  
**AK-1172-00**



**DOUGLAS**  
Ø 3,0 mm  
**AK-1175-00**



Ø 6,0 mm **AK-1020-06**  
Ø 10,0 mm **AK-1020-10**

**POOLE**  
22,0 cm, 8 5/8"



Ø 6,0 mm **AK-1021-06**  
Ø 8,0 mm **AK-1021-08**

**POOLE**  
22,0 cm, 8 5/8"



**Saugrohre**  
**SuAKion Tubes**  
**Tubos para aspiración**  
**Tubi aspirazione**



auswechselbar  
interchangeable  
punta intercambiable  
tipo intercambiabile

Ø 3,5 mm  
**AK-1010-35**

**COUPLAND**  
17,0 cm, 6<sup>3</sup>/<sub>4</sub>"  
**AK-1010-17**



**AK-1024-00**  
Olive allein  
Olive only  
Oliva suelto  
Olivo solo



**YANKAUER**  
27,0 cm, 10<sup>5</sup>/<sub>8</sub>"  
**AK-1000-27**



**DE BAKEY**  
27,0 cm, 10<sup>5</sup>/<sub>8</sub>"  
**AK-1008-27**



**ANTHONY**  
26,0 cm, 10<sup>1</sup>/<sub>4</sub>"  
**AK-1007-26**



**ANDREWS-PYNCHON**  
24,0 cm, 9<sup>1</sup>/<sub>2</sub>"  
**AK-1006-24**



**COOLEY**  
35,0 cm, 13<sup>3</sup>/<sub>4</sub>"  
Ø 8,0 mm  
**AK-1024-02**



**COOLEY**  
30,0 cm, 11<sup>3</sup>/<sub>4</sub>"  
Ø 7,0 mm  
**AK-1024-03**



**COOLEY**  
31,0 cm, 11<sup>3</sup>/<sub>4</sub>"  
Ø 10,0 mm  
**AK-1024-04**



**COOLEY**  
33,0 cm, 13"  
Ø 8,0 mm  
**AK-1024-01**



Ø 2,0 mm

**COGSWELL**  
23,0 cm, 9"  
**AK-1014-23**



Saugrohre  
SuAKion Tubes  
Tubos para aspiración  
Tubi aspirazione



Ø 1,5 mm **AK-1012-15**  
Ø 2,5 mm **AK-1012-25**  
Ø 3,5 mm **AK-1012-35**

**BYRD**  
20,0 cm, 8"



Ø 4,0 mm

**HEPP/SCHIEDEL**  
22,5 cm, 8<sup>3</sup>/<sub>4</sub>"  
**AK-1016-22**



**ADSON**  
21,0 cm, 8<sup>1</sup>/<sub>4</sub>"  
**AK-1050-21**



Ø 1,0 mm **AK-1060-01**  
Ø 2,0 mm **AK-1060-02**  
Ø 3,0 mm **AK-1060-03**  
Ø 4,0 mm **AK-1060-04**

**MAGILL**  
17,5 cm, 6<sup>5</sup>/<sub>8</sub>"



Charr. 6 **AK-1030-06**  
Charr. 8 **AK-1030-08**  
Charr. 10 **AK-1030-10**  
Charr. 12 **AK-1030-12**

**FRAZIER**  
19,0 cm, 7<sup>1</sup>/<sub>2</sub>"



Charr. 6 **AK-1033-06**  
Charr. 8 **AK-1033-08**  
Charr. 10 **AK-1033-10**  
Charr. 12 **AK-1033-12**

**FERGUSON**  
18,0 cm, 7"



Charr. 6 **AK-1034-06**  
Charr. 8 **AK-1034-08**  
Charr. 10 **AK-1034-10**  
Charr. 12 **AK-1034-12**

**POPPEN**  
13,0 cm, 5"



**VASE** INSTRUMENTS  
PREMIUM QUALITY INSTRUMENTS

**Galle, Leber, Niere, Blase, Urologie  
Gall, Liver, Kidney, Bladder, Urology  
Bilis, Hígado, Riñon, Vejiga, Urología  
Bile, Fegato, Rene, Vescica, Urologia**





**NierenAKeinzangen, GallenAKeinzangen**  
**Kidney AKone Forceps, Gall AKone Forceps**  
**Pinzas para los cálculos renales, Pinzas para los cálculos biliares**  
**Pinze per calcoli renali, Pinze per calcoli biliari**



**RANDALL**

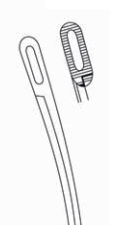

23,0 cm, 9"  
**AK-1001-01**

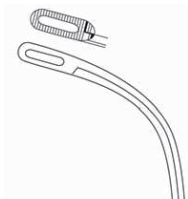

22,0 cm, 8<sup>5</sup>/<sub>8</sub>"  
**AK-1001-02**

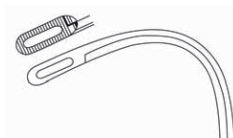

22,0 cm, 8<sup>5</sup>/<sub>8</sub>"  
**AK-1001-03**



22,0 cm, 8<sup>5</sup>/<sub>8</sub>"  
**AK-1001-04**

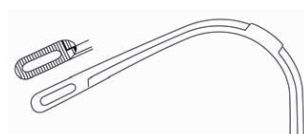

19,0 cm, 7<sup>1</sup>/<sub>2</sub>"  
**AK-1001-05**



19,0 cm, 7<sup>1</sup>/<sub>2</sub>"  
**AK-1001-06**



**DESJARDINS**  
23,0 cm, 9"



**AK-1001-01**

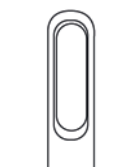

**AK-1001-02**



**MIXTER**  
22,0 cm, 8<sup>5</sup>/<sub>8</sub>"  
**AK-1021-22**



**MAYO BLAKE**  
20,0 cm, 8"  
**AK-1008-20**



20,0 cm, 8"  
**AK-1009-20**



GallenAKEinzangen  
Gall AKone Forceps  
Pinzas para los cálculos biliares  
Pinze per calcoli biliari



**BLAKE**  
20,0 cm, 8"  
AK-1006-20



20,0 cm, 8"  
AK-1005-20



**TUAKER-WARWICK**  
18,0 cm, 7"



AK-1031-01

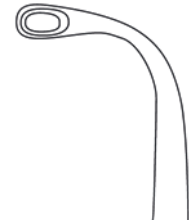

AK-1031-01



**SÖKELAND**  
24,0 cm, 9½"  
AK-1037-24

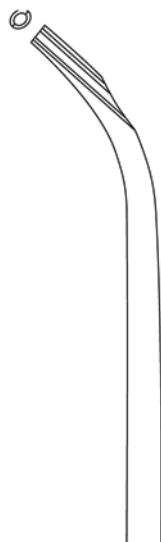

**CZEAKY**  
24,5 cm, 9⅝"  
AK-1039-24





**GallenAKeinlöffel**  
**Gall AKone Scoops**  
**Cucharillas para los cálculos biliares**  
**Cucchiai per calcoli biliari**

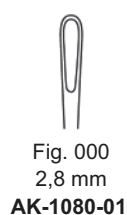

Fig. 000  
2,8 mm  
**AK-1080-01**

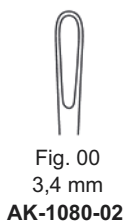

Fig. 00  
3,4 mm  
**AK-1080-02**



Fig. 2  
6,7 mm  
**AK-1080-05**



Fig. 3  
8,0 mm  
**AK-1080-06**

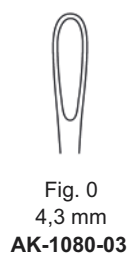

Fig. 0  
4,3 mm  
**AK-1080-03**



Fig. 1  
5,5 mm  
**AK-1080-04**



Fig. 4  
11,0 mm  
**AK-1080-07**



Fig. 5  
15,0 mm  
**AK-1080-08**



**LUER-KÖAKE**  
24,0 cm, 9½"



**FERGUSSON**  
21,5 cm, 8½"  
**AK-1070-01**



**MAYO**  
27,0 cm, 10<sup>5</sup>/<sub>8</sub>"  
**AK-1072-01**



**MAYO**  
27,0 cm, 10<sup>5</sup>/<sub>8</sub>"



**AK-1074-01**

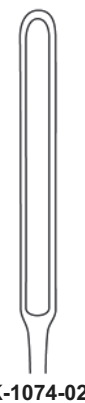

**AK-1074-02**



**MOYNIHAN**  
34,0 cm, 13<sup>3</sup>/<sub>8</sub>"  
**AK-1076-34**



**MATU**  
32,0 cm, 12 1/2"  
AK-1078-32



**OCHSNER**  
35,0 cm, 13 3/4"  
AK-1082-35



**DESJARDINS**  
28,0 cm, 11"



**MOORE**  
30,0 cm, 12"  
AK-1084-30

Gallenblasenlöffel  
Gall bladder scoope  
Cuccharilla para la vesicula biliar  
Cucchiaio per colecisti



**DESJARDINS**  
28,0 cm, 11"

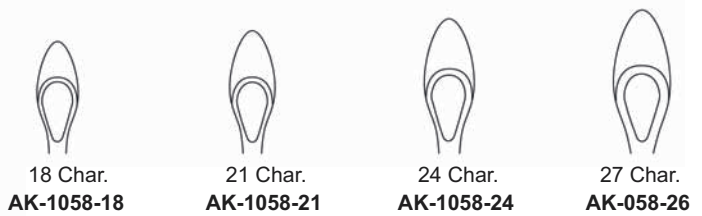

Gallengangsonden, Gallengang Dilatoren  
Gall DuAK Probes, Common Bile DuAK Dilators  
Sonas p. el conduAKo biliar, Diladores para el conduAKo biliar  
Dilatatori per condotti biliari, Dilatori per coledoco





**Gallengang Dilatatoren**  
**Common Bile DuAK Dilators**  
**Dilatadores para el conducto biliar**  
**Dilatatori per coledoco**



**BAKES**  
30,0 cm, 11<sup>3</sup>/<sub>4</sub>"  
**AK-1000-30**

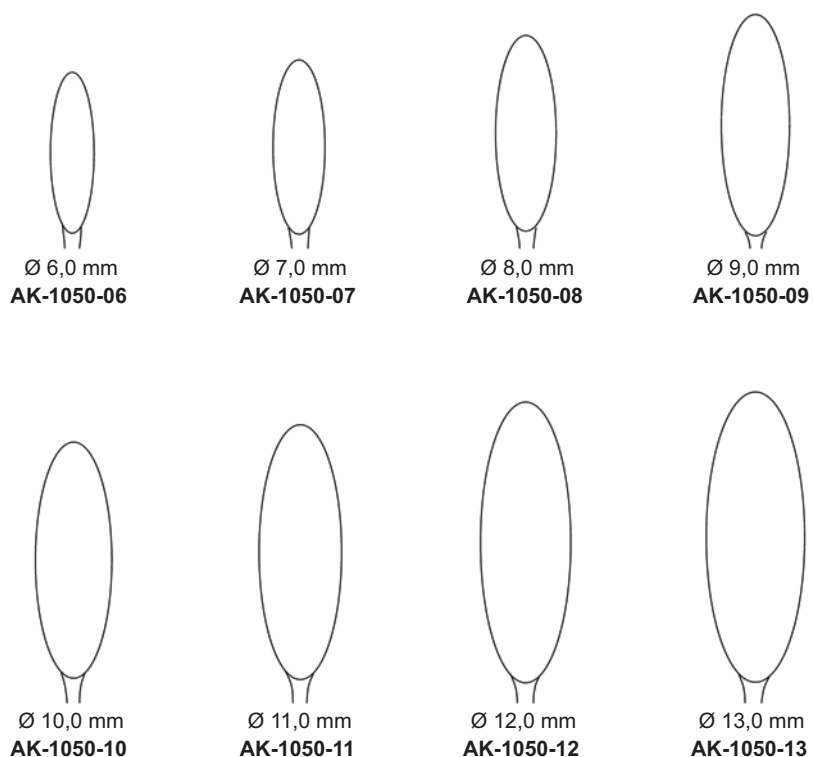



**Blasenwundspreizer  
Bladder RetraAKors  
Deparadores para la vejiga  
Divaricatori vescicali**





InAKrumente für ProAKatektomie  
ProAKateAKomy InAKruments  
InAKrumentos para la proAKateAKomía  
AKrumenti per operazioni della proAKata



**MILLIN**  
23,0 cm, 9"  
AK-1073-23



**ATRAUMA**

**MILLIN**  
24,0 cm, 9½"  
AK-1071-24



**MILLIN**  
24,0 cm, 9½"  
AK-1077-24



**MILLIN**  
23,0 cm, 9"  
AK-1075-23



**MILLIN**  
28,5 cm, 11¼"  
AK-1150-24

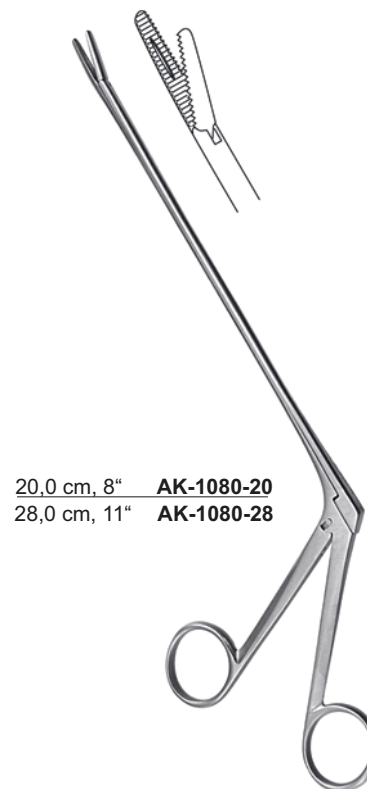

20,0 cm, 8" **AK-1080-20**  
28,0 cm, 11" **AK-1080-28**

**MATHIEU**



ProAKatahaken, Blasenspatel  
ProAKatic RetraAKors, Bladder RetraAKor  
Separadores para la proAKata, Separadores vesicales  
Retrattori proAKatici, Divaricatori vescicali



**YOUNG**  
21,0 cm, 8<sup>1</sup>/<sub>4</sub>"  
AK-1230-21



**YOUNG**  
22,0 cm, 8<sup>5</sup>/<sub>8</sub>"  
AK-1236-22



**YOUNG**  
21,0 cm, 8<sup>1</sup>/<sub>4</sub>"  
AK-1238-21



**YOUNG**  
22,0 cm, 8<sup>5</sup>/<sub>8</sub>"  
AK-1240-22



**LEGUEU**  
26,0 cm, 10<sup>1</sup>/<sub>4</sub>"  
AK-1250-26



**KOCHER**  
23,5 cm, 9<sup>1</sup>/<sub>4</sub>"  
AK-1257-23



**Katheter, Penisklappen**  
**Catheters, Penis Clamp**  
**Sondas, Compresor urétral**  
**Cateteri, Serrapene**



für Männer  
for men  
para hombres  
per uomini

Char. 8	<b>AK-1650-08</b>
Char. 10	<b>AK-1650-10</b>
Char. 12	<b>AK-1650-12</b>
Char. 14	<b>AK-1650-14</b>
Char. 16	<b>AK-1650-16</b>
Char. 18	<b>AK-1650-18</b>
Char. 20	<b>AK-1650-20</b>
Char. 22	<b>AK-1650-22</b>
Char. 24	<b>AK-1650-24</b>

29,0 cm, 11½"



für Frauen  
for women  
para mujeres  
per donne

Char. 6	<b>AK-1660-06</b>
Char. 7	<b>AK-1660-07</b>
Char. 8	<b>AK-1660-08</b>
Char. 9	<b>AK-1660-09</b>
Char. 10	<b>AK-1660-10</b>
Char. 11	<b>AK-1660-11</b>
Char. 12	<b>AK-1660-12</b>
Char. 13	<b>AK-1660-13</b>
Char. 14	<b>AK-1660-14</b>
Char. 15	<b>AK-1660-15</b>
Char. 16	<b>AK-1660-16</b>
Char. 18	<b>AK-1660-18</b>
Char. 20	<b>AK-1660-20</b>
Char. 24	<b>AK-1660-24</b>

16,0 cm, 6¼"



**AKRAUSS**  
11,0 cm, 4⅓"  
**056-1349-11**



**AKOCKMANN**  
8,0 cm, 3¼"  
**AK-1345-08**

Ø 8,0 mm	<b>AK-1350-08</b>
Ø 11,0 mm	<b>AK-1350-11</b>
Ø 13,0 mm	<b>AK-1350-13</b>
Ø 16,0 mm	<b>AK-1350-16</b>
Ø 21,0 mm	<b>AK-1350-21</b>
Ø 26,0 mm	<b>AK-1350-26</b>
Ø 32,0 mm	<b>AK-1350-32</b>



**COMCO**



**VASE** INSTRUMENTS  
PREMIUM QUALITY INSTRUMENTS

**Magen, Darm, MaAKdarm  
AKomach, InteAKines, ReAKum  
EAKómoago, InteAKino, ReAKo  
AKomaco, InteAKino, Retto**





Darm- und Gewebefäßzangen  
InteAKinal and Tissue Grasping Forceps  
Pinzas inteAKinales y para tejidos  
Pinze da presa per inteAKino e tessuti

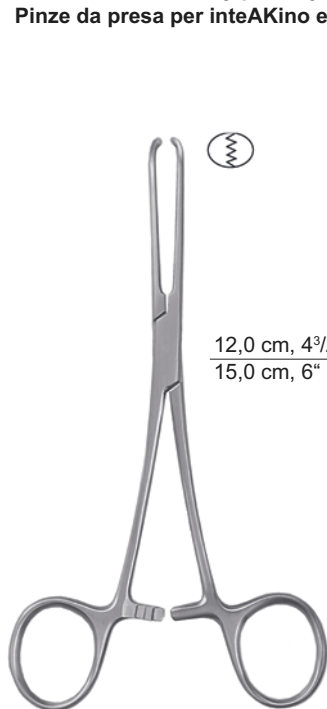

12,0 cm, 4<sup>3</sup>/<sub>4</sub>" **AK-1000-12**  
15,0 cm, 6" **AK-1000-15**

**ALLIS-BABY**

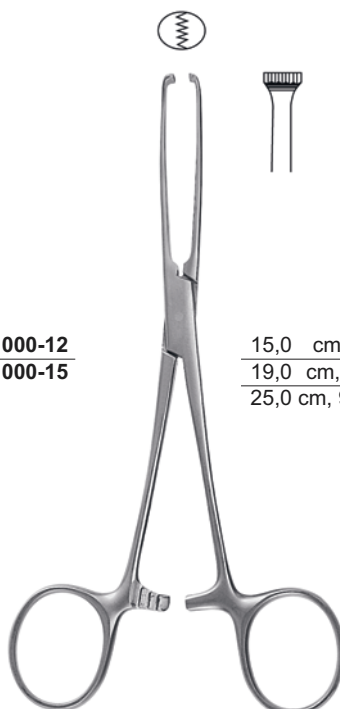

15,0 cm, 6" **AK-1004-15**  
19,0 cm, 7<sup>1</sup>/<sub>2</sub>" **AK-1004-19**  
25,0 cm, 9<sup>3</sup>/<sub>4</sub>" **AK-1004-25**

**ALLIS**

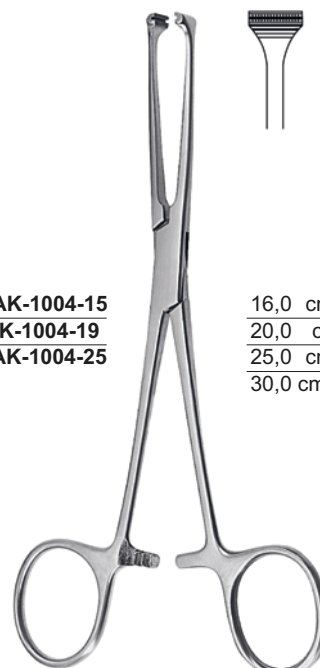

16,0 cm, 6<sup>1</sup>/<sub>4</sub>" **AK-1124-16**  
20,0 cm, 8" **AK-1124-20**  
25,0 cm, 9<sup>3</sup>/<sub>4</sub>" **AK-1124-25**  
30,0 cm, 11<sup>3</sup>/<sub>4</sub>" **AK-1124-30**

**ALLIS-ATRAUMA**



15,5 cm, 6" **AK-1020-15**  
20,0 cm, 8" **AK-1020-20**  
23,0 cm, 9" **AK-1020-23**

**ALLEN**

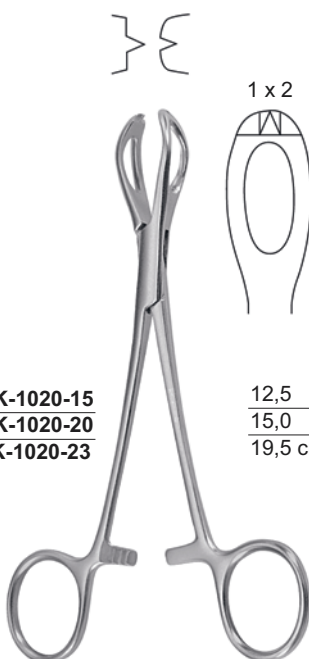

1 x 2

12,5 cm, 5" **AK-1030-12**  
15,0 cm, 6" **AK-1030-15**  
19,5 cm, 7<sup>3</sup>/<sub>4</sub>" **AK-1030-19**

**LANE**

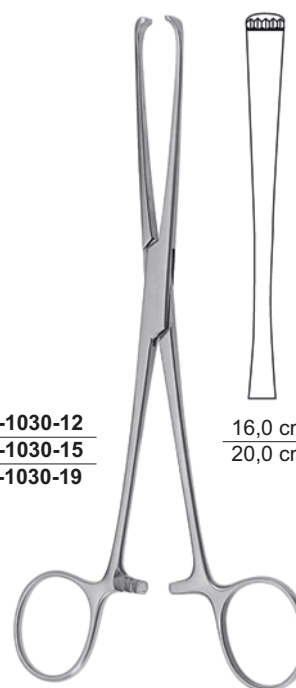

16,0 cm, 6<sup>1</sup>/<sub>4</sub>" **AK-1178-16**  
20,0 cm, 8" **TF-1178-20**

**LOCKWOOD-ALLIS**

Darm- und Gewebefäßzangen  
InteAKinal and Tissue Grasping Forceps  
Pinzas inteAKinales y para tejidos  
Pinze da presa per inteAKino e tessuti



15,0 cm, 6" **AK-1040-15**  
19,0 cm, 7½" **AK-1040-19**

**JUDD-ALLIS**



**LITTLEWOOD**  
18,5 cm, 7¼"  
**AK-1060-16**



**ALLIS-ADAIR**  
15,5 cm, 6"  
**AK-1010-15**

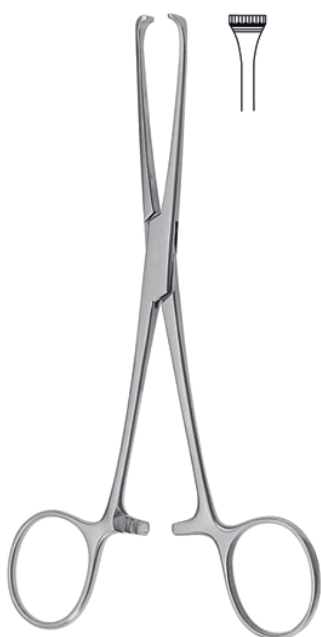

**BOYS-ALLIS**  
15,5 cm, 6"  
**AK-1012-15**



**THOMS-ALLIS**  
20,0 cm, 8"  
**AK-1050-20**



**ALLIS**  
20,0 cm, 8"  
**AK-1014-20**





**Darm- und Gewebefaßzangen**  
**InteAKinal and Tissue Grasping Forceps**  
**Pinzas inteAKinales y para tejidos**  
**Pinze da presa per inteAKino e tessuti**



**LOCKWOOD**  
20,0 cm, 8"  
**AK-1178-20**

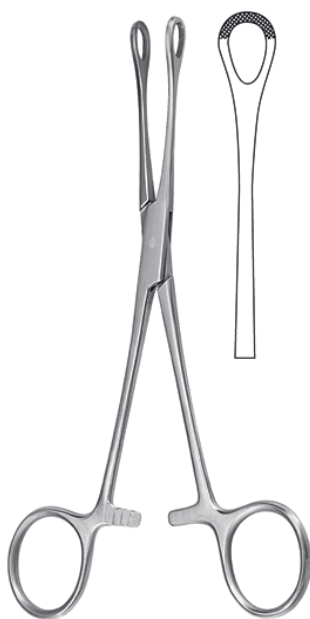

**WILLIAMS**  
16,0 cm, 6 1/4"  
**AK-1070-16**

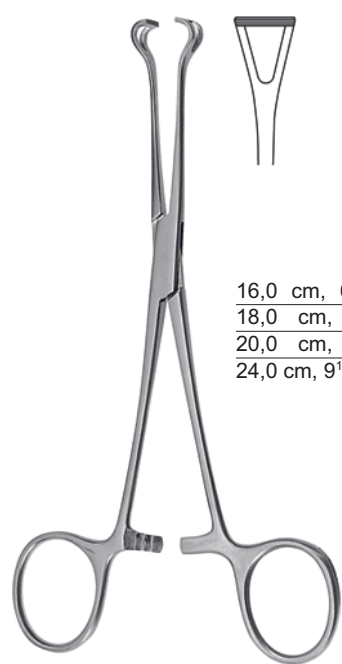

16,0 cm, 6 1/4" **AK-1006-16**  
18,0 cm, 7" **AK-1006-18**  
20,0 cm, 8" **AK-1006-20**  
24,0 cm, 9 1/2" **AK-1006-24**

**BAAKOCK**



16,0 cm, 6 1/4" **AK-1006-16**  
20,0 cm, 8" **AK-1006-20**

**BAAKOCK-ATRAUMA**



16,0 cm, 6 1/4" **AK-1006-16**  
20,0 cm, 8" **AK-1006-20**

**BAAKOCK-TC**



**DUVAL-TC**  
20,0 cm, 8"  
**AK-1170-20**

Darmklemmen  
InteAKinal Clamp Forceps  
Pinzas-clamps inteAKinales  
Pinze inteAKinali



18,0 cm, 7"	<b>AK-1170-18</b>
20,0 cm, 8"	<b>AK-1170-20 AK-1172-20</b>
23,0 cm, 9"	<b>AK-1172-23</b>

Darm- und Gewebefaßzangen  
InteAKinal and Tissue Grasping Forceps  
Pinzas inteAKinales y para tejidos  
Pinze da presa per inteAKino e tessuti

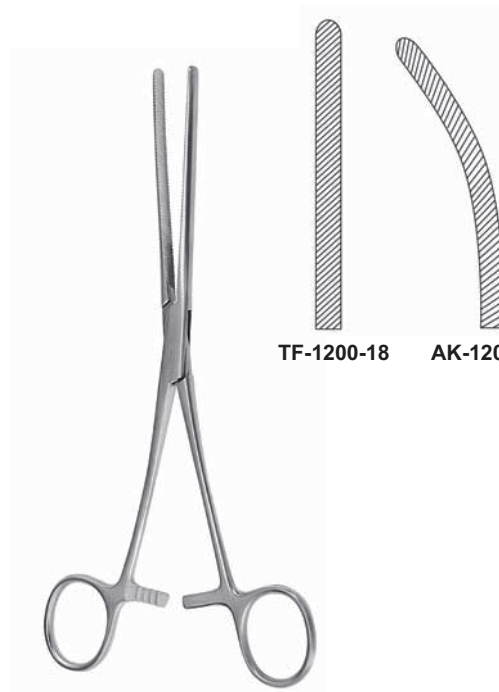

TF-1200-18    AK-1201-18

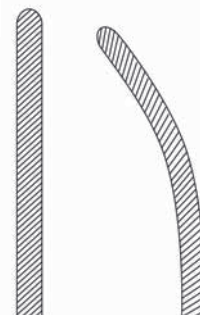

21,0 cm, 8 <sup>1</sup> / <sub>4</sub> "	<b>AK-1210-21</b>	21,0 cm, 8 <sup>1</sup> / <sub>4</sub> "	<b>AK-1211-21</b>
23,0 cm, 9"	<b>AK-1210-23</b>	23,0 cm, 9"	<b>AK-1211-23</b>

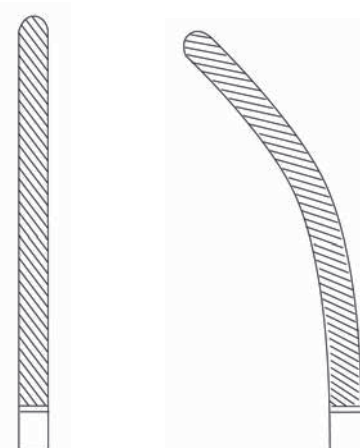



Darmklemmen  
InteAKinal Clamp Forceps  
Pinzas-clamps inteAKinales  
Pinze inteAKinali

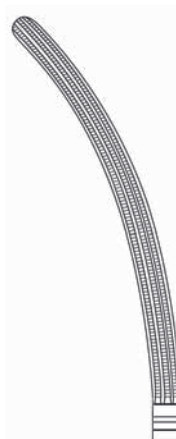
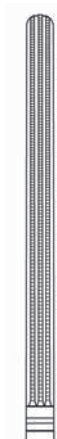

21,0 cm, 8<sup>1</sup>/<sub>4</sub>" **AK-1210-21**  
23,0 cm, 9" **054-1210-23**

21,0 cm, 8<sup>1</sup>/<sub>4</sub>" **AK-1211-21**  
23,0 cm, 9" **AK-1211-23**

mit atraumatischer Zahnung  
with atraumatic serration  
con bacos atraumáticos  
con morsi atraumatici

**DOYEN**



22,0 cm, 8<sup>5</sup>/<sub>8</sub>" **AK-1234-22**  
25,0 cm, 9<sup>3</sup>/<sub>4</sub>" **AK-1234-25**  
28,0 cm, 11" **AK-1234-28**

22,0 cm, 8<sup>5</sup>/<sub>8</sub>" **AK-1235-22**  
25,0 cm, 9<sup>3</sup>/<sub>4</sub>" **AK-1235-25**  
28,0 cm, 11" **AK-1235-28**

**ROCHER**



Darmklemmen  
InteAKinal Clamp Forceps  
Pinzas-clamps inteAKinales  
Pinze inteAKinali



mit atraumatischer Zahnung  
with atraumatic serration  
con bacos atraumáticas  
con morsi atraumatici

**KOCHER**



22,0 cm, 8<sup>5</sup>/<sub>8</sub>" **AK-1234-22**  
25,0 cm, 9<sup>3</sup>/<sub>4</sub>" **AK-1234-25**  
28,0 cm, 11" **AK-1234-28**



22,0 cm, 8<sup>5</sup>/<sub>8</sub>" **AK-1234-22**  
25,0 cm, 9<sup>3</sup>/<sub>4</sub>" **AK-1234-25**  
28,0 cm, 11" **AK-1234-28**



**MAYO-ROBSON**



21,0 cm, 8<sup>1</sup>/<sub>4</sub>" **AK-1230-21**  
23,0 cm, 9" **AK-1230-23**  
25,0 cm, 9<sup>3</sup>/<sub>4</sub>" **AK-1230-25**



21,0 cm, 8<sup>1</sup>/<sub>4</sub>" **AK-1231-21**  
23,0 cm, 9" **AK-1231-23**  
25,0 cm, 9<sup>3</sup>/<sub>4</sub>" **AK-1231-25**



**Darmklemmen**  
**InteAKinal Clamp Forceps**  
**Pinzas-clamps inteAKinales**  
**Pinze inteAKinali**



**MAYO-ROBSON**

21,0 cm, 8<sup>1</sup>/<sub>4</sub>" **AK-1230-21**  
23,0 cm, 9" **AK-1230-23**  
25,0 cm, 9<sup>3</sup>/<sub>4</sub>" **AK-1230-25**

mit atraumatischer Zahnung  
with atraumatic serration  
con bacos atraumáticos  
con morsi atraumatici



21,0 cm, 8<sup>1</sup>/<sub>4</sub>" **AK-1231-21**  
23,0 cm, 9" **AK-1231-23**  
25,0 cm, 9<sup>3</sup>/<sub>4</sub>" **AK-1231-25**

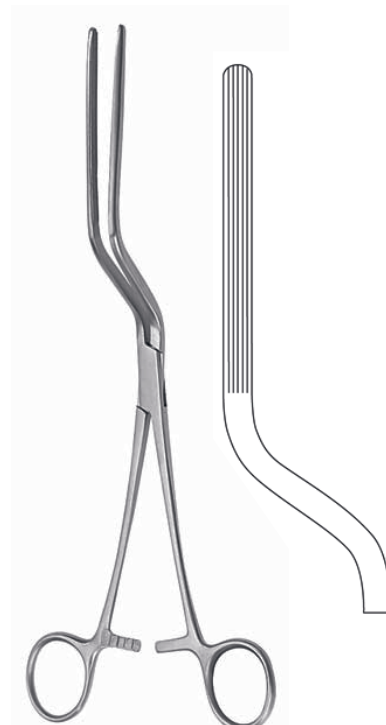

**BRUNNER**  
24,0 cm, 9<sup>1</sup>/<sub>2</sub>"  
**AK-1240-24**

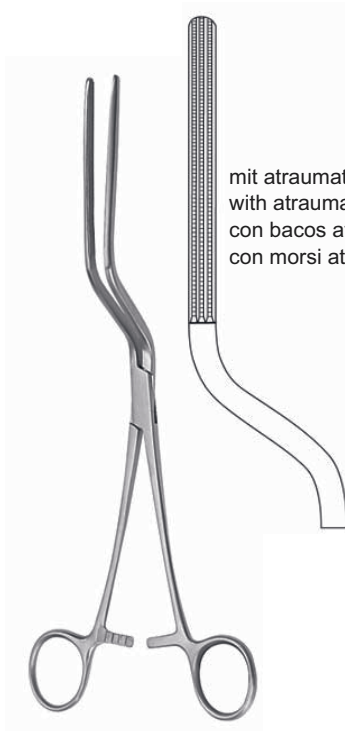

**BRUNNER**  
24,0 cm, 9<sup>1</sup>/<sub>2</sub>"  
**AK-1240-24**

mit atraumatischer Zahnung  
with atraumatic serration  
con bacos atraumáticos  
con morsi atraumatici

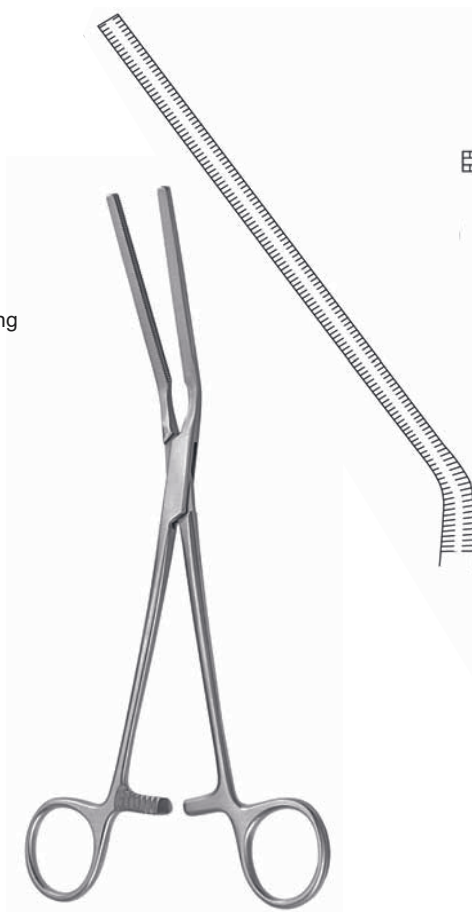

**GLASSMAN**  
23,0 cm, 9"  
**AK-1259-23**



**GLASSMAN**  
23,5 cm, 9<sup>1</sup>/<sub>4</sub>"  
**AK-1253-23**

**Darm- und Magenquetschklemmen**  
**InteAKinal and AKomach Clamps**  
**Pinzas-clamps inteAKinales y eAKomacales**  
**Pinze/Clamp per inteAKino e AKomaco**

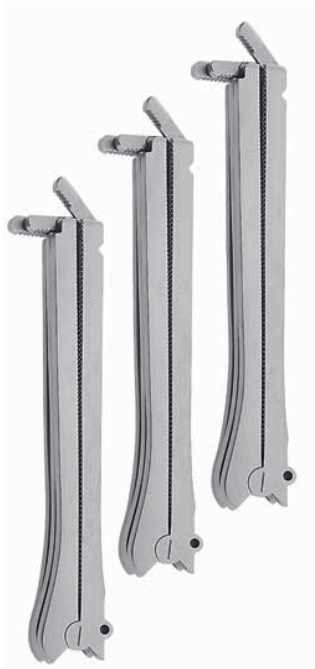

Maußlänge  
length of jaws  
longitud de la boca  
bocche lungh.

5,0 cm, 2"	<b>SC-1320-05</b>
7,0 cm, 2 1/2"	<b>SC-1320-07</b>
10,0 cm, 4"	<b>SC-1320-10</b>

**DE MAAKEL-WOLFSON**



**DE MAAKEL-WOLFSON**

8,5 cm, 3 1/2"  
**SC-1340-08**



**DE MAAKEL-WOLFSON**

26,0 cm, 10 1/4"  
**SC-1325-26**



**BABY-PAYR**  
15,0 cm, 6"



**SC-1310-15**  
mit AKift  
with pin  
con espiga  
con peAKo



**SC-1311-15**  
ohne AKift  
without pin  
sin espiga  
senza peAKo



**PAYR**



21,0 cm, 8 1/4" **SC-1310-21** **SC-1311-21**  
29,0 cm, 11 1/2" **SC-1310-29** **SC-1311-29**



mit AKift with pin con espiga con peAKo	ohne AKift without pin sin espiga senza peAKo
--	--



**Darm- und Magenklammern**  
**InteAKinal and AKomach Clamp Forceps**  
**Pinzas-clamps inteAKinales y eAKomacales**  
**Pinze per inteAKino e AKomaco**



SC-1360-30

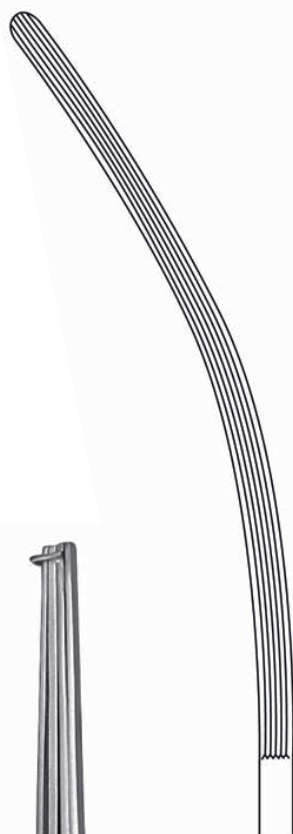

SC-1361-30

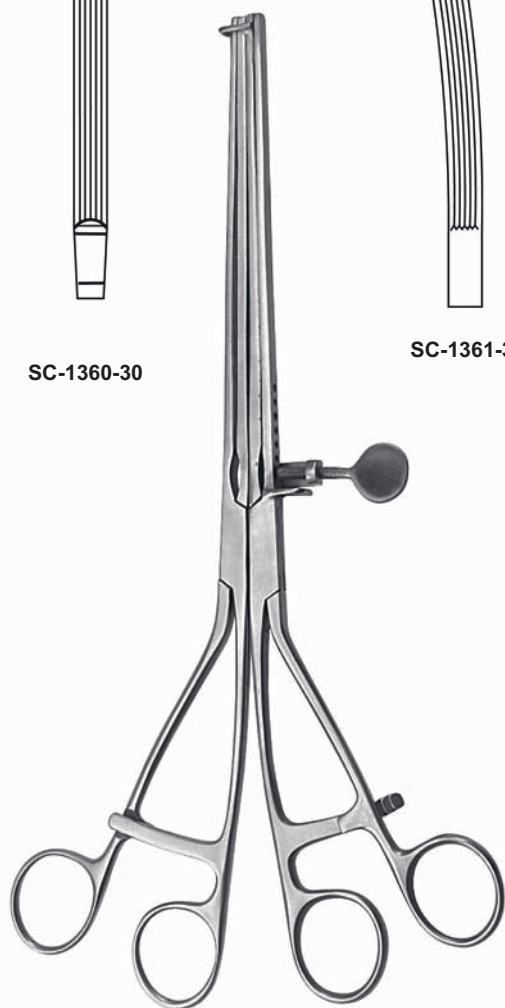

**LANE**  
30,0 cm, 11<sup>3</sup>/<sub>4</sub>"



SC-1364-33



SC-1365-33

mit atraumatischer Zahnung  
with atraumatic serration  
con bacos atraumáticas  
con morsi atraumatici



**SCUDDER**  
33,0 cm, 13"



Rektum-AnaAKomosenklemmen  
Sigmoid AnaAKomosis Forceps  
Pinzas para anaAKomosis de reAKo  
Pinze per anaAKomosi de retto



**MIKULICZ**  
19,0 cm, 7 1/2"  
SC-1010-19

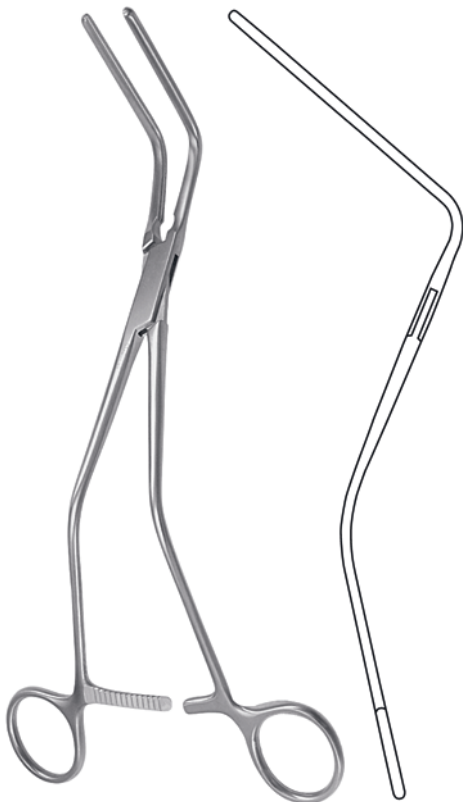
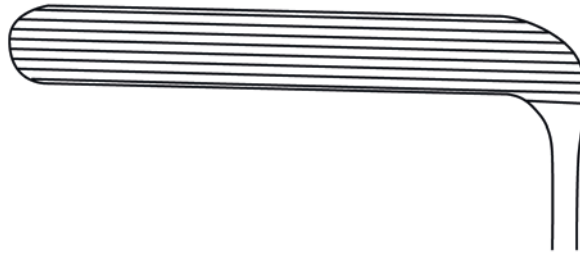

**HAYES**

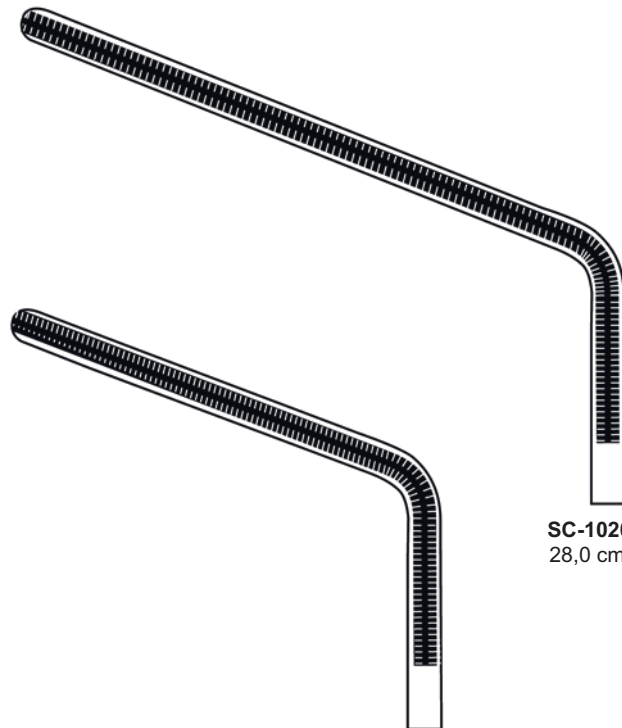

**SC-1020-26**  
26,0 cm, 10"

**SC-1020-28**  
28,0 cm, 11"





MaAKdarm-Rektum-Spekula  
ReAKal Specula  
Espéculos para el reAKo  
Speculi rettali

17 x 89 mm



17 x 89 mm

**SIMS**  
15,0 cm, 6"  
SC-1108-15



**SIMS**  
15,0 cm, 6"  
SC-1110-15



25 x 89 mm

**MATHIEU**  
21,0 cm, 8 1/4"  
SC-1150-21



75 x 23 mm

**SMITH-BUIE**  
15,0 cm, 6"  
SC-1160-15

Analspreizer, Sphinkterskope, Anuskope  
ReAKal RetraAKor, SphinAKeroscopes, Anoscope  
Separadores para el reAKo, Esfiteroscopios, Anoscopios  
Dilatatori per l'ano ed il retti, Sfinteroscopi, Anoscopi

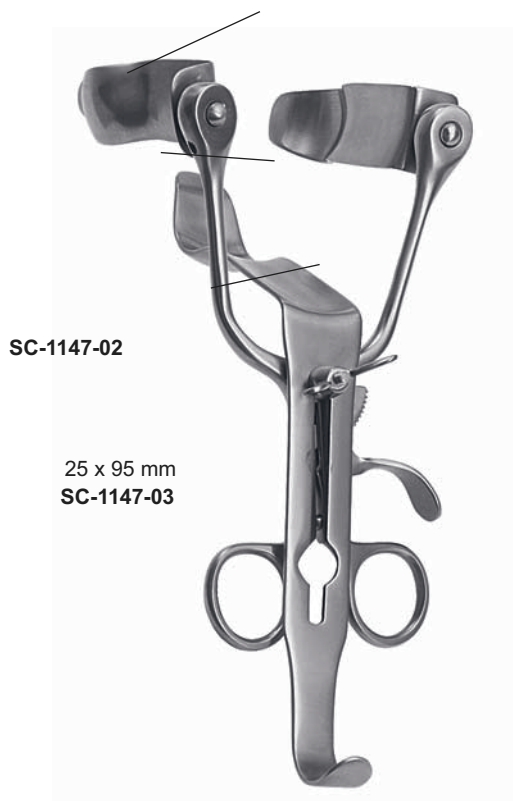

**ALAN PARAK**  
13,5 cm, 5<sup>3</sup>/<sub>8</sub>"  
SC-1147-00



Kaltlichtkammer für Proktoskope  
Cold-light clip for proAKoscopes  
Clip para luz fría con proAKoscopios  
Clip per luce fredda con protoscopi

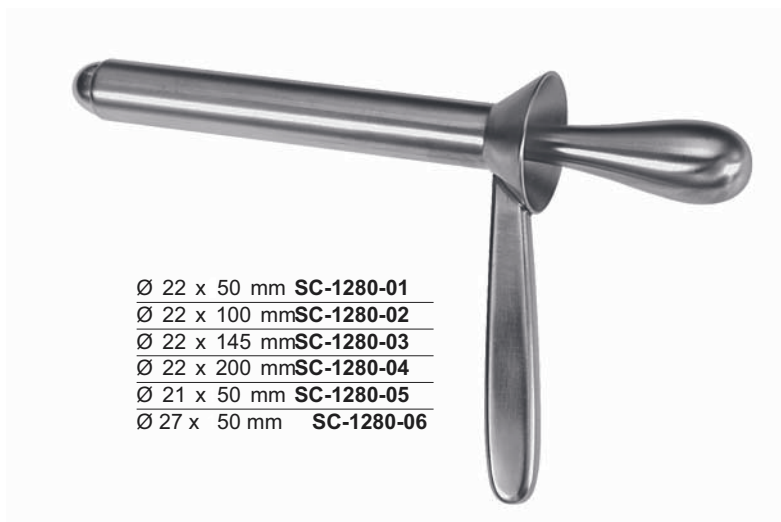

**HAYES**



**HIRSCHMANN**



Anuskope, Proktoskope  
Anoscope, ProAKoscopes  
Anoscopios, ProAKoscopios  
Anoscopi, Protoscopi



Ø 22 x 65 mm **SC-1250-22**  
Ø 30 x 65 mm **SC-1250-30**

**CHELSEA EATON**



ohne Kaltlichtträger  
without cold light carrier  
sin poAKador para luz fría  
senza luce fredda

mit Kaltlichtträger  
with cold light carrier  
con poAKador para luz fría  
con luce fredda

**IVES FANSLER**  
Ø 22 mm  
**SC-1268-01**

**IVES FANSLER**  
Ø 22 mm  
**SC-1268-02**



Ø 17 x 65 mm **SC-1220-01**  
Ø 17 x 80 mm **SC-1220-02**  
Ø 20 x 65 mm **SC-1220-03**  
Ø 20 x 80 mm **SC-1220-04**  
Ø 24 x 65 mm **SC-1220-05**  
Ø 24 x 80 mm **SC-1220-06**

**MORGAN**



Ø 25 x 65 mm **SC-1124-25**  
Ø 29 x 65 mm **SC-1124-29**  
Ø 38 x 70 mm **SC-1124-38**

**FANSLER**

**055-1000-02**



**MaAKdarm-Biopsiezangen**  
**ReAKal Biopsy Forceps**  
**Pinzas sacabocado para biopsia reAKal**  
**Pinze taglianti per biopsia rettale**



28,0 cm, 11" **SC-1300-28**  
35,0 cm, 13<sup>3</sup>/<sub>4</sub>" **SC-1300-35**  
42,0 cm, 16<sup>1</sup>/<sub>2</sub>" **SC-1300-42**

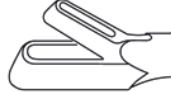

28,0 cm, 11" **SC-1311-28**  
35,0 cm, 13<sup>3</sup>/<sub>4</sub>" **SC-1311-35**  
42,0 cm, 16<sup>1</sup>/<sub>2</sub>" **SC-1311-42**

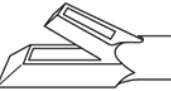

28,0 cm, 11" **SC-1301-28**  
35,0 cm, 13<sup>3</sup>/<sub>4</sub>" **SC-1301-35**  
42,0 cm, 16<sup>1</sup>/<sub>2</sub>" **SC-1301-42**

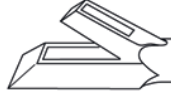

28,0 cm, 11" **SC-1312-28**  
35,0 cm, 13<sup>3</sup>/<sub>4</sub>" **SC-1312-35**  
42,0 cm, 16<sup>1</sup>/<sub>2</sub>" **SC-1312-42**

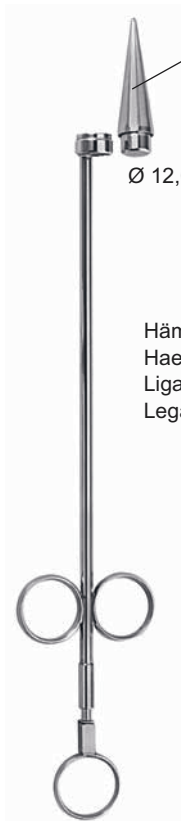

**SC-1405-00**

Ø 12,0 mm

Hämorrhoiden-Ligator mit Ladekonus  
Haemorrhoidal ligator with loading attachment  
Ligador para hemorroides con cono de carga  
Legatori emorroidali con carica a cono

**RUDD**  
**SC-1400-00**

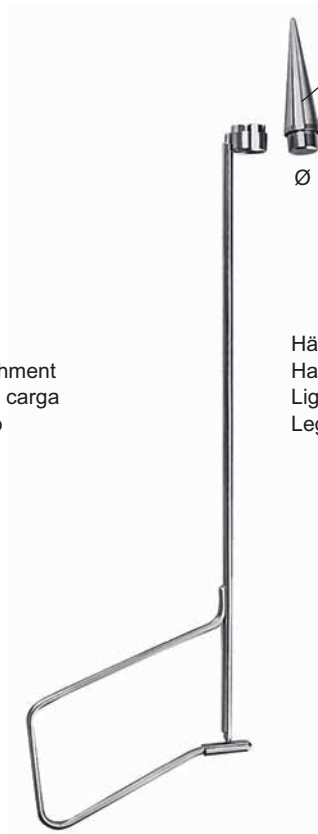

**SC-1405-00**

Ø 12,0 mm

Hämorrhoiden-Ligator mit Ladekonus  
Haemorrhoidal ligator with loading attachment  
Ligador para hemorroides con cono de carga  
Legatori emorroidali con carica a cono

**MC GIVNEY**  
**SC-1410-00**



Hämorrhoiden-Faßzangen, FiAKelsonden  
Haemorrhoidal Forceps, FiAKula probes  
Pinza-clamps para hemorroides, Sondas para fiAKula  
Pinze per emorroidi, Sonde per fiAKola



**MC GIVNEY**  
19,0 cm, 7½"  
SC-1471-19



**MC GIVNEY**  
19,0 cm, 7½"  
SC-1473-19



**PRATT**  
21,0 cm, 8¼"



SC-1135-01



SC-1135-02



SC-1135-03



**VASE** INSTRUMENTS  
PREMIUM QUALITY INSTRUMENTS

**Gynäkologie, GebuAAKhilfe**  
**Gynecology, ObAKetrics**  
**Ginecología, ObAKetricia**  
**Ginecologia, OAKetricia**





**Scheidenspekula  
Vaginal Specula  
Espéculos vaginales  
Speculi vaginali**

für Kinder  
for children  
para niños  
per bambini



**COLLIN**  
65 x 10 mm  
**GO-1134-00**

für Jungfrauen  
for virgins  
para virgenes  
per vergini



**COLLIN**  
65 x 10 mm  
**GO-1134-00**



<b>COLLIN</b>	
85 x 30 mm	<b>GO-1130-01</b>
100 x 35 mm	<b>GO-1130-02</b>
110 x 40 mm	<b>GO-1130-03</b>



<b>CUSCO</b>	
80 x 24 mm	<b>GO-1142-01</b>
80 x 32 mm	<b>GO-1142-02</b>
98 x 16 mm	<b>GO-1142-03</b>
105 x 25 mm	<b>GO-1142-04</b>
107 x 29 mm	<b>GO-1142-05</b>
115 x 35 mm	<b>GO-1142-06</b>

**Scheidenspekula  
Vaginal Specula  
Espéculos vaginales  
Speculi vaginali**

zentrale AKellschraube  
central fi xation screw  
toAKillo de sujeto central  
vite di regolazione centrale



**CUSCO**

75 x 32 mm	<b>GO-1144-01</b>
85 x 36 mm	<b>GO-1144-02</b>
95 x 37 mm	<b>GO-1144-03</b>

seitliche AKellschraube  
lateral fi xation screw  
toAKillo de sujeto lateral  
vite di regolazione laterale



für Jungfrauen  
for virgins  
para virgenes  
per vergini

**CUSCO**

75 x 17 mm  
**GO-1140-00**

seitliche AKellschraube  
lateral fi xation screw  
toAKillo de sujeto lateral  
vite di regolazione laterale



**CUSCO**

75 x 32 mm	<b>GO-1140-01</b>
85 x 35 mm	<b>GO-1140-02</b>
100 x 35 mm	<b>GO-1140-03</b>

ScAKEizer Modell  
Swiss patteAK  
Modelo suizo  
Modello svizzero



**CUSCO**

90 x 23-25 mm	<b>GO-1146-01</b>
100 x 25-27 mm	<b>GO-1146-02</b>
110 x 27-30 mm	<b>GO-1146-03</b>





Scheidenspekula  
Vaginal Specula  
Espéculos vaginales  
Speculi vaginali



**GRAVE**

75 x 20 mm	<b>GO-1100-01</b>
95 x 35 mm	<b>GO-1100-02</b>
115 x 35 mm	<b>GO-1100-03</b>



**PEDERSON**

75 x 13 mm	<b>GO-1120-01</b>
100 x 22 mm	<b>GO-1120-02</b>
120 x 25 mm	<b>GO-1120-03</b>



**SEMM**

90 x 14-18 mm	<b>GO-1150-01</b>
100 x 17-20 mm	<b>GO-1150-02</b>
100 x 25-30 mm	<b>GO-1150-03</b>



**WEISSBAAKH**

21,0 cm, 8 1/4"	<b>GO-1160-00</b>
-----------------	-------------------

Scheidenspekula  
Vaginal Specula  
Espéculos vaginales  
Speculi vaginali



mit abnehmbarem Gewicht  
with detachable weight  
con peso desmontable  
con peso smontabile

1,14 kg

**AUVARD**  
75 x 38 mm  
GO-1170-00



mit feAKem Gewicht  
with fi xed weight  
con peso fi jo  
con peso fi sso

1,14 kg

**AUVARD**  
75 x 38 mm  
GO-1170-00



GO-1180-03

400 g  
GO-1180-40

800 g  
GO-1180-80

**SCHERBACK**  
GO-1180-00

koplett, complete, completo, completo

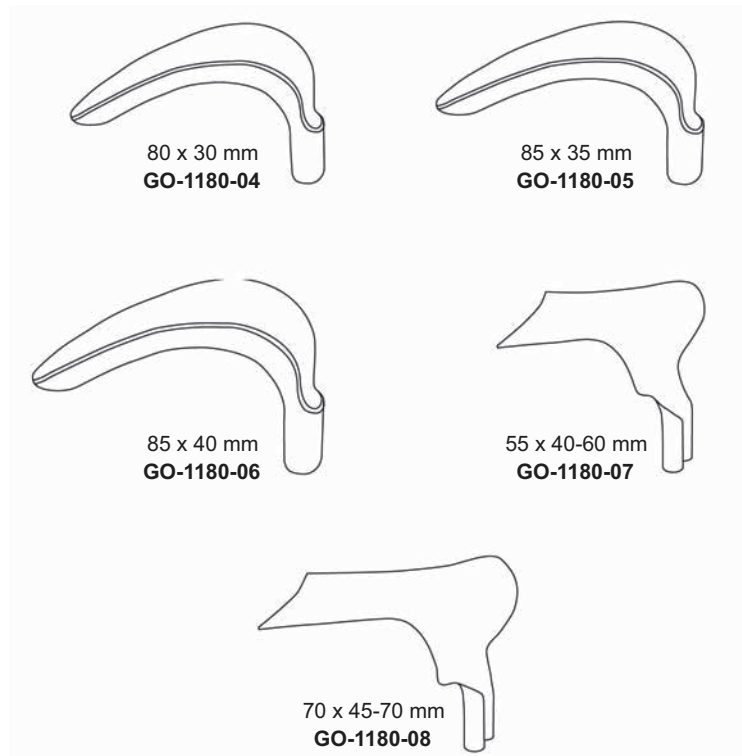



**Scheidenspekula**  
**Vaginal Specula**  
**Espéculos vaginales**  
**Speculi vaginali**



Satz  
Set  
Juego  
Set

**KRIAKELLER**  
Fig. 1 **GO-1220-01**  
Fig. 2 **GO-1220-02**  
Fig. 3 **GO-1220-03**



Spekula allein, fl ach  
Specula only, fl at hollow  
Espéculos suelto, con huecos planos  
Solo speculi, piatta

**KRIAKELLER**  
105 x 26 mm **GO-1221-01**  
105 x 28 mm **GO-1221-02**  
105 x 33 mm **GO-1221-03**



Halter allein  
RetraAKors only  
Valvas suelto  
Solo valve

**KRIAKELLER**  
115 x 22 mm **GO-1222-01**  
115 x 24 mm **GO-1222-02**  
115 x 29 mm **GO-1222-03**



Satz  
Set  
Juego  
Set

**KRIAKELLER**  
Fig. 1 **GO-1230-01**  
Fig. 2 **GO-1230-02**  
Fig. 3 **GO-1230-03**

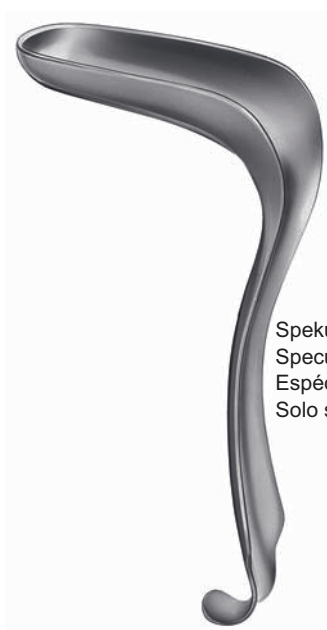

Spekula allein, fl ach  
Specula only, fl at hollow  
Espéculos suelto, con huecos planos  
Solo speculi, piatta

**KRIAKELLER**  
110 x 27 mm **GO-1231-01**  
110 x 30 mm **GO-1231-02**  
110 x 36 mm **GO-1231-03**

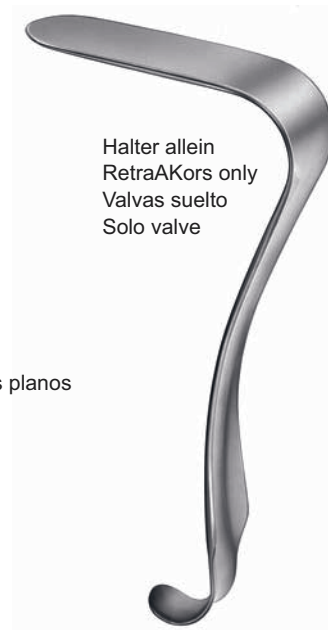

Halter allein  
RetraAKors only  
Valvas suelto  
Solo valve

**KRIAKELLER**  
115 x 23 mm **GO-1232-01**  
115 x 26 mm **GO-1232-02**  
115 x 32 mm **GO-1232-03**

Scheidenspekula  
Vaginal Specula  
Espéculos vaginales  
Speculi vaginali



Satz  
Set  
Juego  
Set

**KRIAKELLER**

Fig. 0 **GO-234-00**  
Fig. 1 **GO-234-01**  
Fig. 2 **GO-234-02**  
Fig. 3 **GO-234-03**



Spekula allein  
Specula only  
Espéculos suelto  
Solo speculi

**KRIAKELLER**

70 x 15 mm **GO-235-00**  
70 x 27 mm **GO-235-01**  
80 x 30 mm **GO-235-02**  
90 x 36 mm **GO-235-03**



Halter allein  
RetraAKors only  
Valvas suelto  
Solo valve

**KRIAKELLER**

75 x 10 mm **GO-236-00**  
75 x 23 mm **GO-236-01**  
85 x 26 mm **GO-236-02**  
100 x 32 mm **GO-236-03**

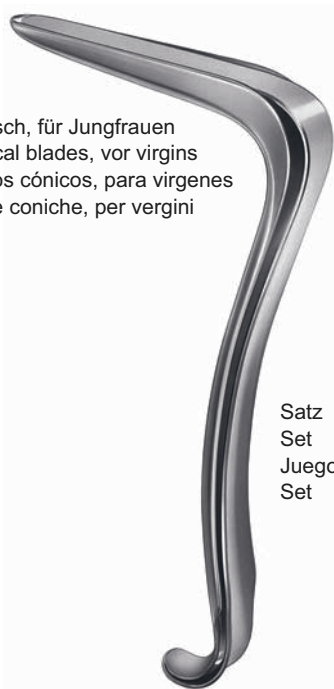

konisch, für Jungfrauen  
conical blades, vor virgins  
valvos cónicos, para virgenes  
valve coniche, per vergini

Satz  
Set  
Juego  
Set

**KRIAKELLER**

Fig. 00 **GO-237-01**  
Fig. 0 **GO-237-02**



Spekula allein  
Specula only  
Espéculos suelto  
Solo speculi

**KRIAKELLER**

105 x 18 mm **GO-238-01**  
105 x 21 mm **GO-238-02**



Halter allein  
RetraAKors only  
Valvas suelto  
Solo valve

**KRIAKELLER**

110 x 14 mm **GO-239-01**  
110 x 17 mm **GO-239-02**



**Scheidenspekula**  
**Vaginal Specula**  
**Espéculos vaginales**  
**Speculi vaginali**



cht hohl  
ghtly-concave  
eremente concavos  
geremente concavi

Fig	a x b	
1	55 x 35 mm	<b>GO-1260-01</b>
2	85 x 35 mm	<b>GO-1260-02</b>
3	115 x 35 mm	<b>GO-1260-03</b>

1	55 x 45 mm	<b>GO-1261-01</b>
2	85 x 45 mm	<b>GO-1261-02</b>
3	115 x 45 mm	<b>GO-1261-03</b>
4	160 x 45 mm	<b>GO-1261-04</b>

1	55 x 60 mm	<b>GO-1262-01</b>
2	85 x 60 mm	<b>GO-1262-02</b>
3	115 x 60 mm	<b>GO-1262-03</b>
4	160 x 60 mm	<b>GO-1262-04</b>

**DOYEN**  
23,0 cm, 9"

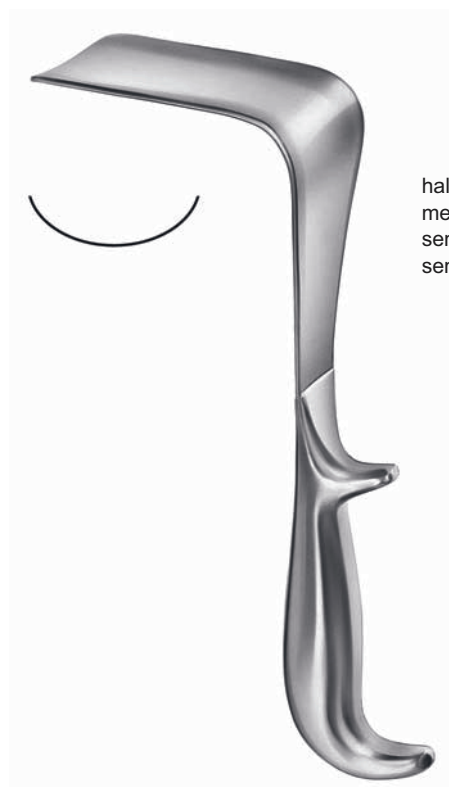

halb-hohl  
medium-concave  
semi-concavos  
semi-concavi

Fig	a x b	
1	55 x 35 mm	<b>GO-1264-01</b>
2	85 x 35 mm	<b>GO-1264-02</b>
3	115 x 35 mm	<b>GO-1264-03</b>

1	55 x 45 mm	<b>GO-1265-01</b>
2	85 x 45 mm	<b>GO-1265-02</b>
3	115 x 45 mm	<b>GO-1265-03</b>

1	55 x 60 mm	<b>GO-1266-01</b>
2	85 x 60 mm	<b>GO-1266-02</b>
3	115 x 60 mm	<b>GO-1266-03</b>

**DOYEN**  
23,0 cm, 9"



**Scheidenspekula  
Vaginal Specula  
Espéculos vaginales  
Speculi vaginali**



Satz  
Set  
Juego  
Set

**KALLMORGEN**  
70 x 40 mm **GO-1270-01**  
90 x 40 mm **GO-1270-02**



Spekula allein  
Specula only  
Espéculos suelto  
Solo speculi

**KALLMORGEN**  
70 x 40 mm **GO-1271-01**  
90 x 40 mm **GO-1271-02**



Halter allein  
RetraAKors only  
Valvas suelto  
Solo valve

**KALLMORGEN**  
70 x 40 mm **GO-1272-01**  
90 x 40 mm **GO-1272-02**



70 x 15 mm

**KRIAKELLER**  
17,0 cm, 6<sup>3</sup>/<sub>4</sub>"  
**GO-1275-17**



75 x 39 mm

**KALLMORGEN**  
17,0 cm, 6<sup>3</sup>/<sub>4</sub>"  
**GO-1290-17**



**JACKON**  
75 x 38 mm **GO-1290-01**  
90 x 38 mm **GO-1290-02**  
100 x 38 mm **GO-1290-03**



Scheidenspekula  
Vaginal Specula  
Espéculos vaginales  
Speculi vaginali

76 x 25 mm



70 x 22 mm

**BREISKY**  
14,0 cm, 5½"  
GO-1292-01

82 x 30 mm



76 x 25 mm

**BREISKY**  
14,0 cm, 5½"  
GO-1292-02

95 x 38 mm



82 x 30 mm

**BREISKY**  
17,0 cm, 6¾"  
GO-1292-03

102 x 44 mm



95 x 38 mm

**BREISKY**  
17,0 cm, 6¾"  
GO-1292-04

**Scheidenspekula und -halter  
Vaginal Specula and RetraAKors  
Espéculos y valvas vaginales  
Speculi e valve vaginali**

**SIMS**  
**GO-1294-00**  
Satz, Set, Juego, Set



**SIMS**  
12,5 cm, 5"  
**GO-1294-01**



**SIMS**  
15,0 cm, 6"  
**GO-1294-02**



**SIMS**  
17,5 cm, 7"  
**GO-1294-03**



**MATHIEU**  
100 x 13-23 mm **GO-1300-01**  
100 x 16-30 mm **GO-1300-02**



**MATHIEU**  
100 x 11-21 mm **GO-1301-01**  
100 x 14-27 mm **GO-1301-02**



**LANDAU**  
100 x 28 mm **GO-1305-01**  
100 x 38 mm **GO-1305-02**





Scheidenspekula  
Vaginal Specula  
Espéculos vaginales  
Speculi vaginali



- 100 x 20 mm **GO-1307-20**
  - 100 x 25 mm **GO-1307-25**
  - 100 x 30 mm **GO-1307-30**
  - 100 x 35 mm **GO-1307-35**
  - 100 x 40 mm **GO-1307-40**
- 
- 130 x 20 mm **GO-1308-20**
  - 130 x 25 mm **GO-1308-25**
  - 130 x 30 mm **GO-1308-30**
  - 130 x 35 mm **GO-1308-35**
  - 130 x 40 mm **GO-1308-40**
- 
- 155 x 40 mm **GO-1309-40**

**BREISKY**

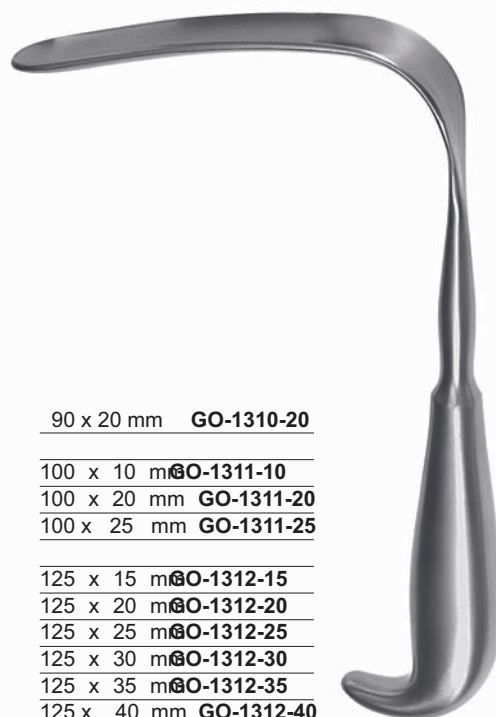

- 90 x 20 mm **GO-1310-20**
- 
- 100 x 10 mm **GO-1311-10**
  - 100 x 20 mm **GO-1311-20**
  - 100 x 25 mm **GO-1311-25**
- 
- 125 x 15 mm **GO-1312-15**
  - 125 x 20 mm **GO-1312-20**
  - 125 x 25 mm **GO-1312-25**
  - 125 x 30 mm **GO-1312-30**
  - 125 x 35 mm **GO-1312-35**
  - 125 x 40 mm **GO-1312-40**

**MATZENAUER**



**BRAUN, MODIF.**  
19,0 cm, 7½"  
**GO-1313-19**



**DOYEN**  
23,0 cm, 9"  
**GO-1315-23**



**DOYEN**  
25,0 cm, 9"  
**GO-1315-25**



**WEAKHEIM**  
30,0 cm, 12"  
**GO-1317-30**

Endospekula, Lateral-Spekulum, Intrauterinsonde  
Endospecula, Lateral Speculum, Intrauterine Probe  
Endospeculos, Espéculo lateral, Sonda intra-uterina  
Endospeculi, Speculo lateral, Sonde intrauterine

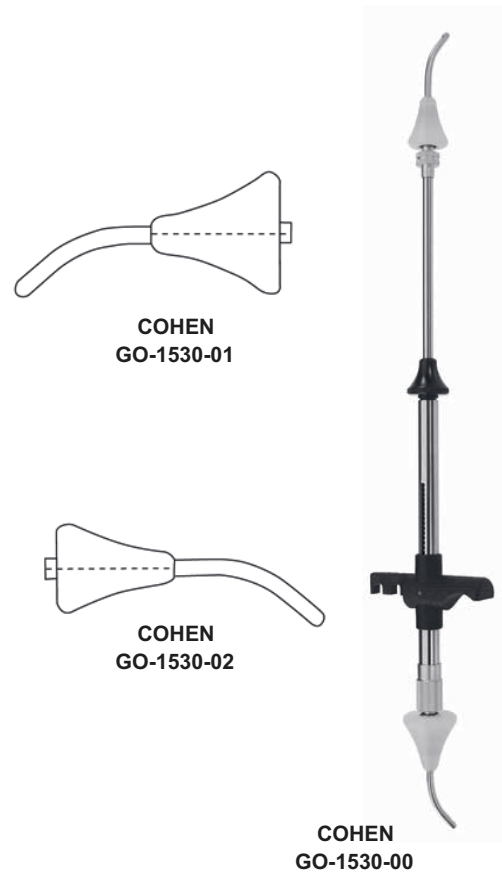
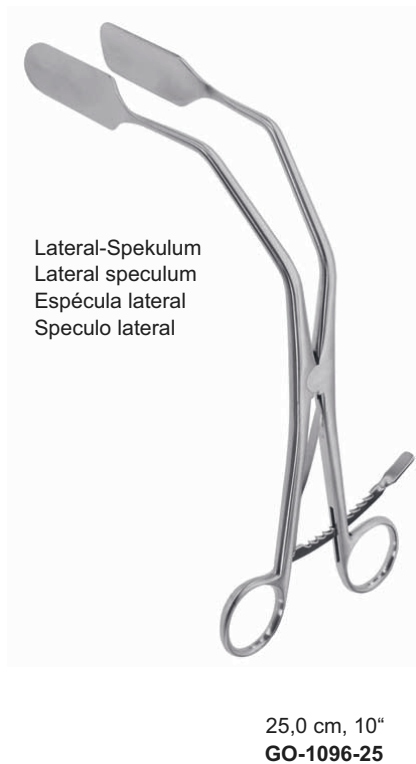
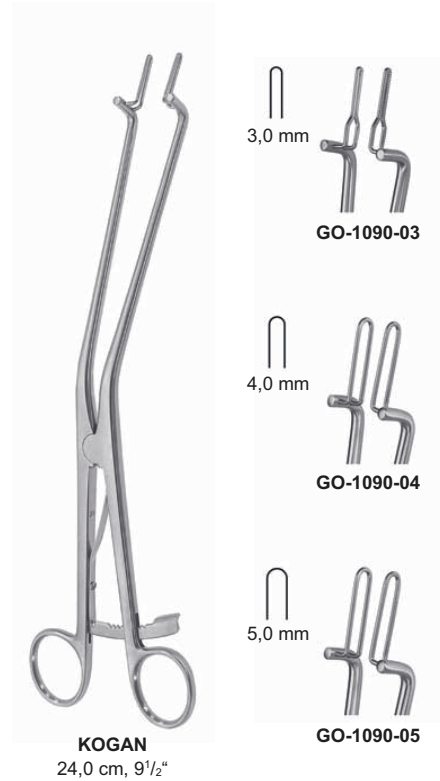



**Uterus-Dilatatoren  
Uterine Dilators  
Dilatadores uterinos  
Dilatatori uterini**



**HEGAR**  
18,5 cm, 7 1/4"

Ø 1,0 mm	<b>GO-1350-01</b>
Ø 2,0 mm	<b>GO-1350-02</b>
Ø 3,0 mm	<b>GO-1350-03</b>
Ø 4,0 mm	<b>GO-1350-04</b>
Ø 5,0 mm	<b>GO-1350-05</b>
Ø 6,0 mm	<b>GO-1350-06</b>
Ø 7,0 mm	<b>GO-1350-07</b>
Ø 8,0 mm	<b>GO-1350-08</b>
Ø 9,0 mm	<b>GO-1350-09</b>
Ø 10,0 mm	<b>GO-1350-10</b>
Ø 11,0 mm	<b>GO-1350-11</b>
Ø 12,0 mm	<b>GO-1350-12</b>
Ø 13,0 mm	<b>GO-1350-13</b>
Ø 14,0 mm	<b>GO-1350-14</b>
Ø 15,0 mm	<b>GO-1350-15</b>
Ø 16,0 mm	<b>GO-1350-16</b>
Ø 17,0 mm	<b>GO-1350-17</b>
Ø 18,0 mm	<b>GO-1350-18</b>
Ø 19,0 mm	<b>GO-1350-19</b>
Ø 20,0 mm	<b>GO-1350-20</b>
Ø 21,0 mm	<b>GO-1350-21</b>
Ø 22,0 mm	<b>GO-1350-22</b>
Ø 23,0 mm	<b>GO-1350-23</b>
Ø 24,0 mm	<b>GO-1350-24</b>
Ø 25,0 mm	<b>GO-1350-25</b>
Ø 26,0 mm	<b>GO-1350-26</b>



**HEGAR**  
18,5 cm, 7 1/4"

Ø 1,5 mm	<b>GO-1351-01</b>
Ø 2,5 mm	<b>GO-1351-02</b>
Ø 3,5 mm	<b>GO-1351-03</b>
Ø 4,5 mm	<b>GO-1351-04</b>
Ø 5,5 mm	<b>GO-1351-05</b>
Ø 6,5 mm	<b>GO-1351-06</b>
Ø 7,5 mm	<b>GO-1351-07</b>
Ø 8,5 mm	<b>GO-1351-08</b>
Ø 9,5 mm	<b>GO-1351-09</b>
Ø 10,5 mm	<b>GO-1351-10</b>
Ø 11,5 mm	<b>GO-1351-11</b>
Ø 12,5 mm	<b>GO-1351-12</b>
Ø 13,5 mm	<b>GO-1351-13</b>
Ø 14,5 mm	<b>GO-1351-14</b>
Ø 15,5 mm	<b>GO-1351-15</b>
Ø 16,5 mm	<b>GO-1351-16</b>
Ø 17,5 mm	<b>057-1351-17</b>



205 x 105 x 45 mm

**HEGAR**  
**GO-1350-99**  
Satz, Set, Juego, Set  
Ø 1,0 - Ø 26,0  
(26 dilators)

**HEGAR**  
**GO-1350-98**  
Satz, Set, Juego, Set  
Ø 4,0 - Ø 17,0  
(14 dilators)



**Uterus-Dilatatoren  
Uterine Dilators  
Dilatadores uterinos  
Dilatatori uterini**



**HEGAR**  
20,0 cm, 8"

1,0 / 2,0 mm	<b>GO-1354-01</b>
Ø 3,0 / 4,0 mm	<b>GO-1354-03</b>
Ø 5,0 / 6,0 mm	<b>GO-1354-05</b>
Ø 7,0 / 8,0 mm	<b>GO-1354-07</b>
Ø 9,0 / 10,0 mm	<b>GO-1354-09</b>
Ø 11,0 / 12,0 mm	<b>GO-1354-11</b>
Ø 13,0 / 14,0 mm	<b>GO-1354-13</b>
Ø 15,0 / 16,0 mm	<b>GO-1354-15</b>
Ø 17,0 / 18,0 mm	<b>GO-1354-17</b>
Ø 19,0 / 20,0 mm	<b>GO-1354-19</b>
Ø 21,0 / 22,0 mm	<b>GO-1354-21</b>
Ø 23,0 / 24,0 mm	<b>GO-1354-23</b>
Ø 25,0 / 26,0 mm	<b>GO-1354-25</b>



**HEGAR  
GO-1354-98**  
Satz, Set, Juego, Set  
Ø 3,0 / 4,0 - Ø 17,0 / 18,0 mm  
(8 dilators)

**HEGAR  
GO-1354-99**  
Satz, Set, Juego, Set  
Ø 1,0 / 2,0 - Ø 25,0 / 26,0 mm  
(13 dilators)



**HANK**

Ø 4,5 / 5,0 mm	<b>GO-1360-05</b>
Ø 5,5 / 6,0 mm	<b>GO-1360-06</b>
Ø 6,5 / 7,0 mm	<b>GO-1360-07</b>
Ø 7,5 / 8,0 mm	<b>GO-1360-08</b>
Ø 8,5 / 9,0 mm	<b>GO-1360-09</b>
Ø 9,5 / 10,0 mm	<b>GO-1360-10</b>



**HANK  
GO-1360-98**  
Satz, Set, Juego, Set  
Ø 4,5 / 5,0 - Ø 9,5 / 10,0 mm  
(6 dilators)



**Uterus-Dilatatoren, Hakenzangen**  
**Uterine Dilators, Uterine Tenaculum Forceps**  
**Dilatadores uterinos, Pinzas para coger el cuello del útero**  
**Dilatatori uterini, Pinze per abbassare il collo dell'utero**



- 4,5 / 5,0 mm **GO-1370-05**
- 5,5 / 6,0 mm **GO-1370-06**
- 7,5 / 8,0 mm **GO-1370-08**
- 8,5 / 9,0 mm **GO-1370-09**
- 9,5 / 10,0 mm **GO-1370-10**
- 11,5 / 12,0 mm **GO-1370-12**
- 12,5 / 13,0 mm **GO-1370-13**
- 13,5 / 14,0 mm **GO-1370-14**

**PRATT**



**PRATT**  
**GO-1370-98**  
Satz, Set, Juego, Set  
Ø 4,5 / 5,0 - Ø 13,5 / 14,0 mm  
(8 dilators)



**BARRETT**  
18,0 cm, 7"  
**GO-1410-18**

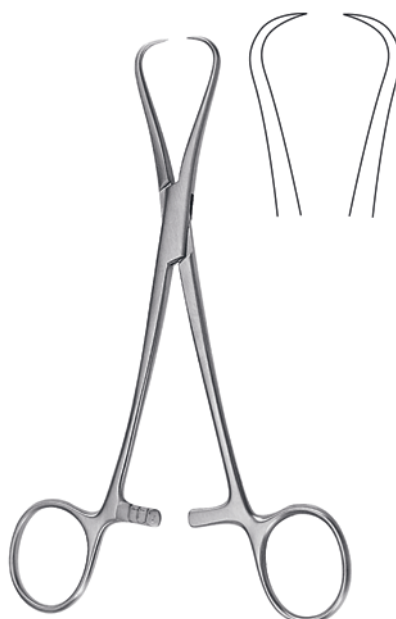

**ADAIR**  
19,0 cm, 7 1/2"  
**GO-1412-19**



**AKAUDE-MOORE**  
17,0 cm, 6 3/4"  
**GO-1414-17**



**Hakenzangen**  
**Uterine Tenaculum Forceps**  
**Pinzas para coger el cuello del útero**  
**Pinze per abbassare il collo dell'utero**

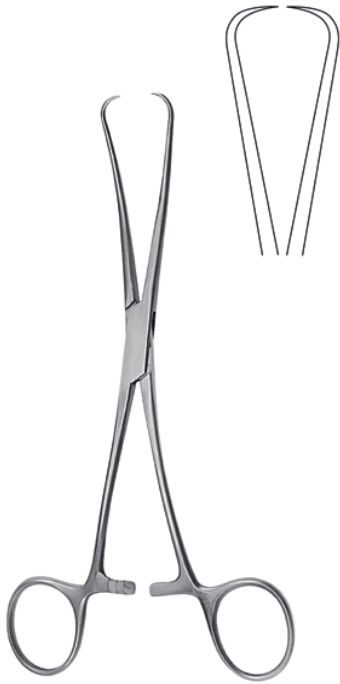

**JARCHO**  
20,0 cm, 8"  
GO-1417-20



**SCHROEDER**  
25,0 cm, 9<sup>3</sup>/<sub>4</sub>"  
GO-1400-25



**BRAUN**  
25,0 cm, 9<sup>3</sup>/<sub>4</sub>"  
GO-1404-25



**DUPLAY**  
28,0 cm, 11"  
GO-1419-28



**POZZI**  
26,0 cm, 10<sup>1</sup>/<sub>4</sub>"  
GO-1402-26



**KAHN**  
24,0 cm, 9<sup>1</sup>/<sub>2</sub>"  
GO-1421-24



**Hakenzangen**  
**Uterine Tenaculum Forceps**  
**Pinzas para coger el cuello del útero**  
**Pinze per abbassare il collo dell'utero**



**SKENE**  
24,0 cm, 9 1/2"  
GO-1423-24



**SCHROEDER**  
24,0 cm, 9 1/2"  
GO-1426-24



**SCHROEDER**  
24,0 cm, 9 1/2"  
GO-1429-24



**TEALE**  
23,0 cm, 9"  
GO-1431-23



**JACOBS**  
21,0 cm, 8 1/2"  
GO-1434-21



**JACOBS**  
21,0 cm, 8 1/2"  
GO-1435-21



**Hakenzangen**  
**Uterine Tenaculum Forceps**  
**Pinzas para coger el cuello del útero**  
**Pinze per abbassare il collo dell'utero**

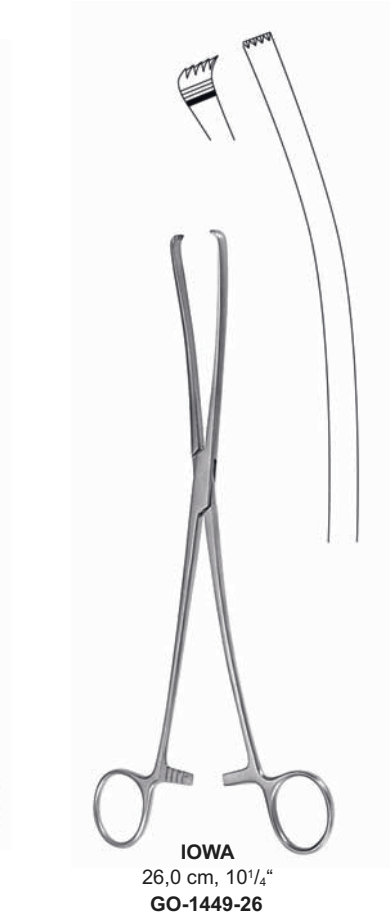
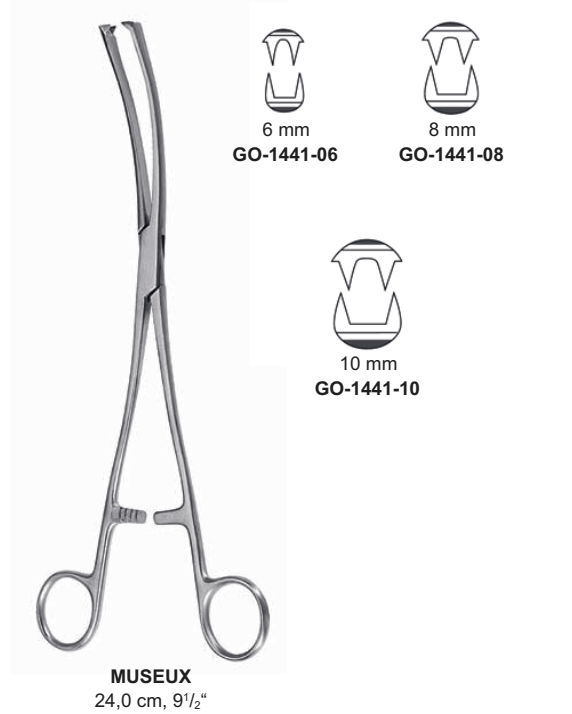
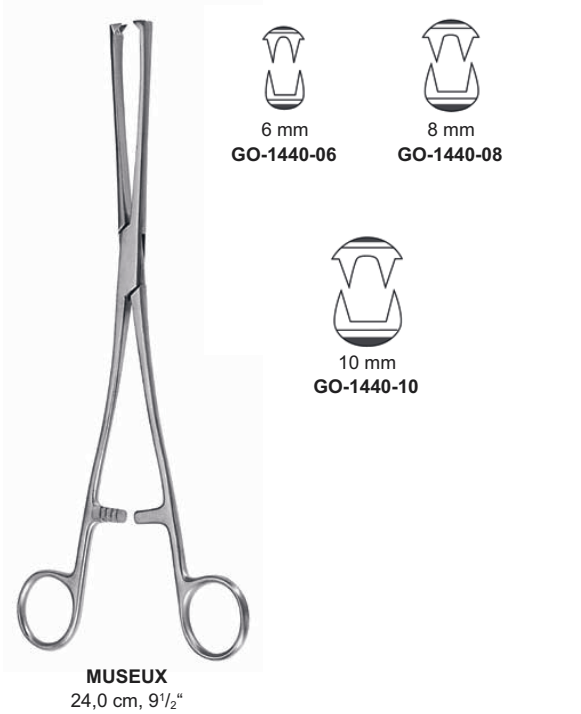





**Polypen- und Ovarienzangen, Uterusfaßzangen**  
**Polypus and Ovum Forceps, Uterine Elevating Forceps**  
**Pinzas para pólipos uterinos y ovarios, Pinzas para la útero**  
**Pinze per polipi e ovaie, Pinze per affarrare l'utero**



**DOYEN**  
20,5 cm, 8"  
GO-1470-20

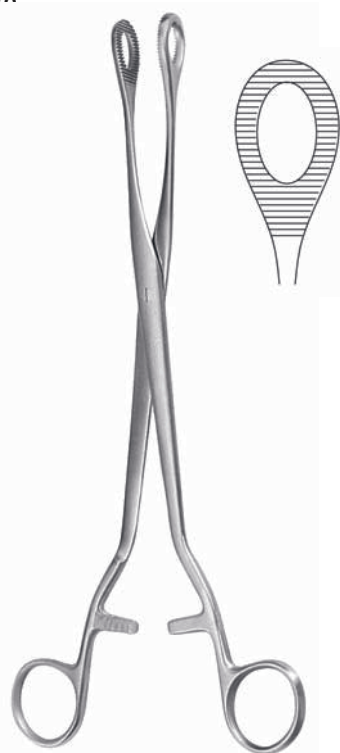

**NOTO**  
27,0 cm, 10<sup>5</sup>/<sub>8</sub>"  
GO-1472-27

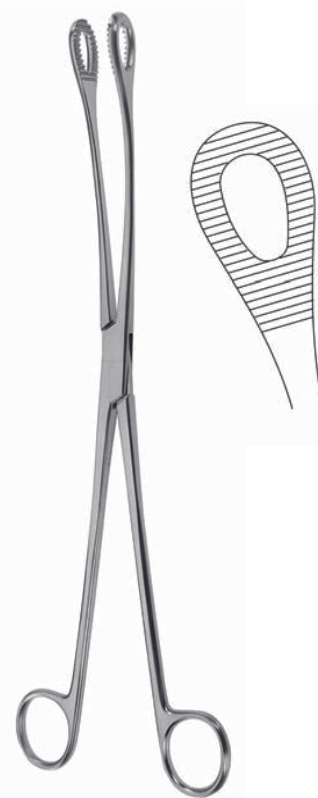

**KELLY**  
32,0 cm, 12<sup>1</sup>/<sub>2</sub>"  
GO-1475-32



**HEYWOOD-SMITH**  
25,0 cm, 9<sup>3</sup>/<sub>4</sub>"  
GO-1480-25



**DAAKIGUES**  
27,0 cm, 10<sup>3</sup>/<sub>4</sub>"  
GO-1482-27



**SOMER**  
23,0 cm, 9"  
GO-1485-23



**Uterusfaßzangen, Uterussonden, Zentimetereinteilung**  
**Uterine Elevating Forceps, Uterine Probes, graduated in centimeters**  
**Pinzas para la útero, HiAKerómetros, graduado en centímetros**  
**Pinze per affarrare l'utero, IAKerometri, graduato in cm**



**COLLIN**  
25,0 cm, 9<sup>3</sup>/<sub>4</sub>"  
GO-1488-25



Amniotom  
Amniotome  
Amniótomo  
Amniotomo

**BEACHAM**  
26,0 cm, 10<sup>1</sup>/<sub>4</sub>"  
GO-1500-26



Uterus-Depressor  
Uterine depressor  
Depresor uterino  
Depressori uterini

**BRAUN**  
28,0 cm, 11"  
GO-1502-28



**SIMS**  
32,0 cm, 12<sup>1</sup>/<sub>2</sub>"  
GO-1510-32



biegsam  
malleable  
maleable  
malleabile

**SIMS**  
32,0 cm, 12<sup>1</sup>/<sub>2</sub>"  
GO-1511-32



**MAAKIN**  
32,0 cm, 12<sup>1</sup>/<sub>2</sub>"  
GO-1516-32



biegsam  
malleable  
maleable  
malleabile

**MAAKIN**  
32,0 cm, 12<sup>1</sup>/<sub>2</sub>"  
GO-1518-32



**VALLEIX**  
25,0 cm, 10"  
GO-1521-25

Ø 4 mm

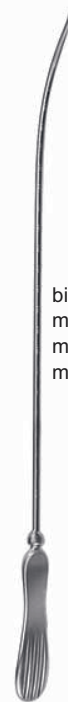

biegsam  
malleable  
maleable  
malleabile

**SIMPSON**  
29,0 cm, 11<sup>1</sup>/<sub>2</sub>"  
GO-1527-29

Ø 4 mm



**COLLIN**  
28,0 cm, 11"  
GO-1529-28



**Biopsieküretten**  
**Biopsy Curettes**  
**Curetas para biopsia**  
**Curette per biopsia**



**KEVORKIAN**  
30,0 cm, 12"  
GO-1540-30



**KEVORKIAN**  
30,0 cm, 12"  
GO-1542-30



**KEVORKIAN**  
30,0 cm, 12"  
GO-1543-30

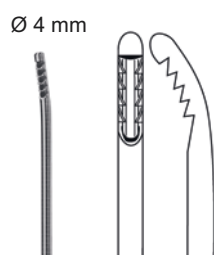

**NOVAK**  
23,0 cm, 9"  
GO-1550-04



**RANDALL**  
23,0 cm, 9"  
GO-1552-04



**MILAN**  
29,0 cm, 11 1/2"



Ø 4 mm  
GO-1560-04

Ø 4 mm  
GO-1560-04

Ø 4 mm  
GO-1560-04



**MyominAKrumente**  
**Myoma InAKruments**  
**InAKrumentos para mioma**  
**AKrumenti per fibroma**



**UTERUSPERFORATOR**  
25,0 cm, 9<sup>3</sup>/<sub>4</sub>"  
GO-1570-25



**FIAKELHAKEN**  
25,0 cm, 9<sup>3</sup>/<sub>4</sub>"  
GO-1572-25



**SIMON**  
22,0 cm, 8<sup>5</sup>/<sub>8</sub>"  
GO-1574-22



**EMMETT**  
22,0 cm, 8<sup>5</sup>/<sub>8</sub>"



GO-1576-01



GO-1576-02



GO-1576-03



v-1576-04



GO-1576-05



**SEGOND**  
27,0 cm, 10<sup>5</sup>/<sub>8</sub>"  
GO-1580-27



**AYRE**  
23,0 cm, 9"  
GO-1583-23

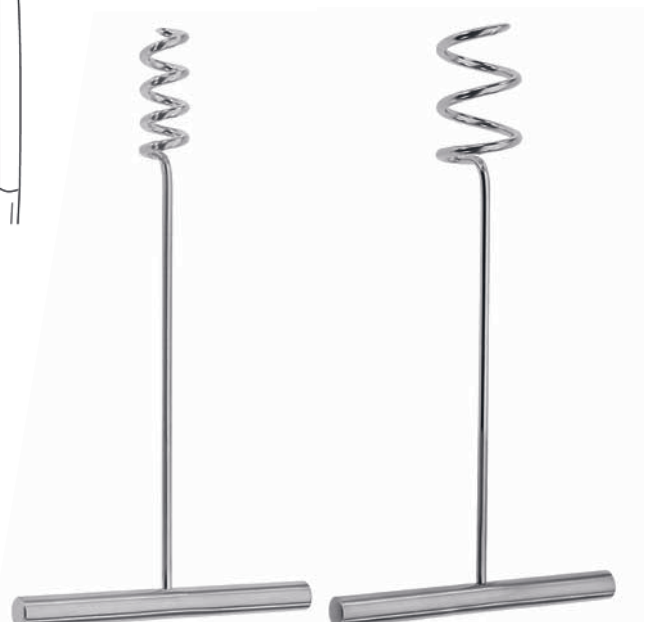
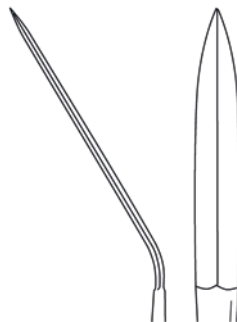

**DOYEN**  
19,0 cm, 7<sup>1</sup>/<sub>2</sub>"  
GO-1588-01

**DOYEN**  
17,0 cm, 6<sup>3</sup>/<sub>4</sub>"  
GO-1588-02



**Uterusküretten**  
**Uterine Curettes**

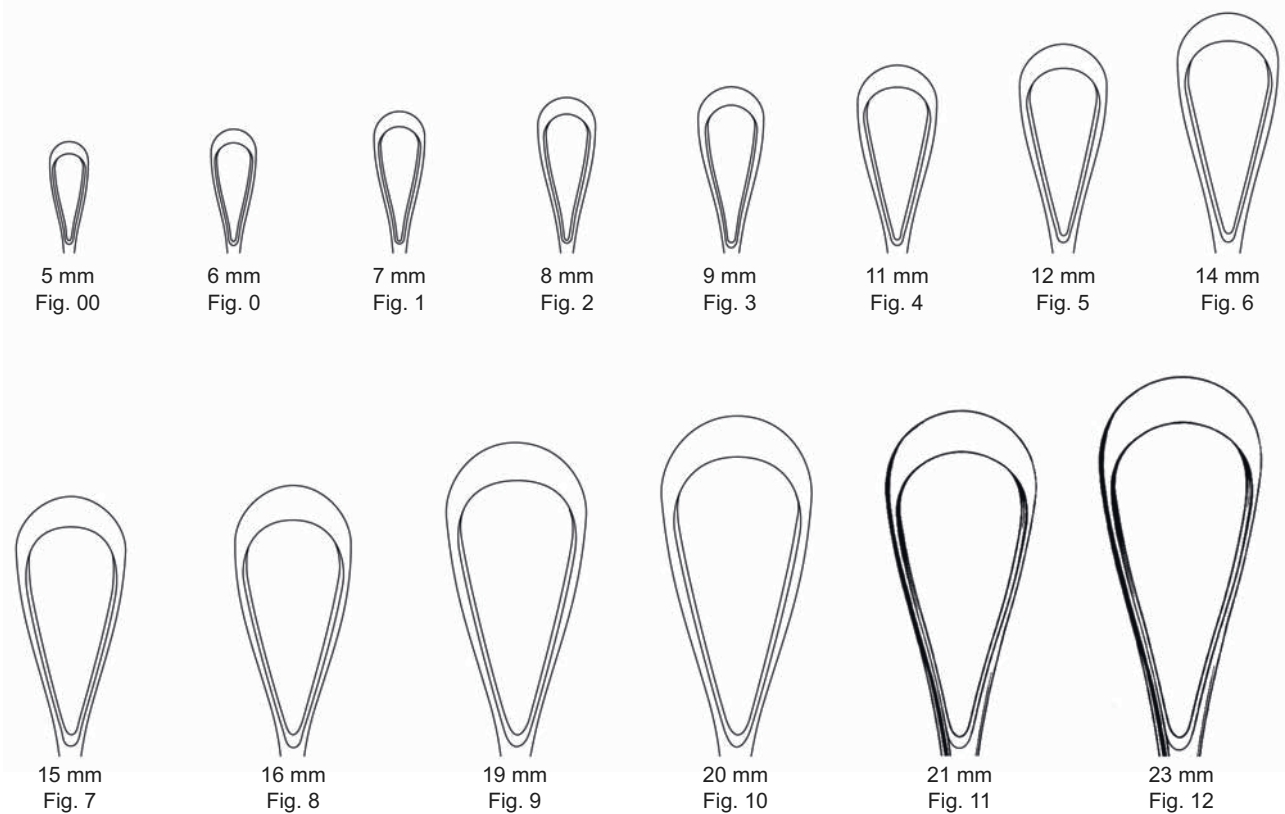

scharf, feAK  
sharp, rigid  
coAKantes, rígidas  
acute, rigide

Fig. 00	GO-1700-05
Fig. 0	GO-1700-06
Fig. 1	GO-1700-07
Fig. 2	GO-1700-08
Fig. 3	GO-1700-09
Fig. 4	GO-1700-11
Fig. 5	GO-1700-12
Fig. 6	GO-1700-14
Fig. 7	GO-1700-15
Fig. 8	GO-1700-16
Fig. 9	GO-1700-19
Fig. 10	GO-1700-20
Fig. 11	GO-1700-21
Fig. 12	GO-1700-23

**RECAMIER**  
26,0 cm, 10¼"



scharf, biegsam  
sharp, malleable  
coAKantes, maleable  
acute, malleabile

Fig. 00	GO-1701-05
Fig. 0	GO-1701-06
Fig. 1	GO-1701-07
Fig. 2	GO-1701-08
Fig. 3	GO-1701-09
Fig. 4	GO-1701-11
Fig. 5	GO-1701-12
Fig. 6	GO-1701-14
Fig. 7	GO-1701-15
Fig. 8	GO-1701-16
Fig. 9	GO-1701-19
Fig. 10	GO-1701-20
Fig. 11	GO-1701-21
Fig. 12	GO-1701-23

**RECAMIER**  
26,0 cm, 10¼"



**Uterusküretten  
Uterine Curettes  
Curetas uterinas  
Curette uterine**

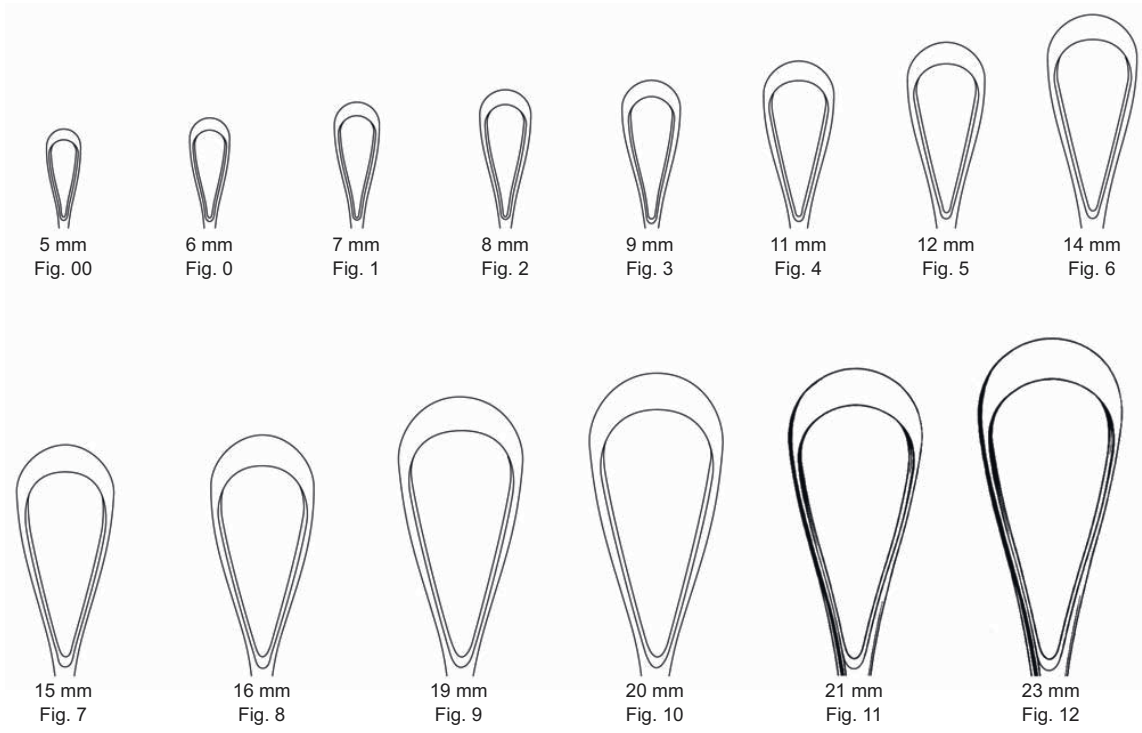

scharf, feAK  
sharp, rigid  
coAKantes, rígidas  
acute, rigide

Fig. 00	GO-1702-05
Fig. 0	GO-1702-06
Fig. 1	GO-1702-07
Fig. 2	GO-1702-08
Fig. 3	GO-1702-09
Fig. 4	GO-1702-11
Fig. 5	GO-1702-12
Fig. 6	GO-1702-14
Fig. 7	GO-1702-15
Fig. 8	GO-1702-16
Fig. 9	GO-1702-19
Fig. 10	GO-1702-20
Fig. 11	GO-1702-21
Fig. 12	GO-1702-23

**SIMS**  
26,0 cm, 10¼"



scharf, biegsam  
sharp, malleable  
coAKantes, maleable  
acute, malleabile

Fig. 00	GO-1703-05
Fig. 0	GO-1703-06
Fig. 1	GO-1703-07
Fig. 2	GO-1703-08
Fig. 3	GO-1703-09
Fig. 4	GO-1703-11
Fig. 5	GO-1703-12
Fig. 6	GO-1703-14
Fig. 7	GO-1703-15
Fig. 8	GO-1703-16
Fig. 9	GO-1703-19
Fig. 10	GO-1703-20
Fig. 11	GO-1703-21
Fig. 12	GO-1703-23

**SIMS**  
26,0 cm, 10¼"



**Uterusküretten**  
**Uterine Curettes**  
**Curetas uterinas**  
**Curette uterine**

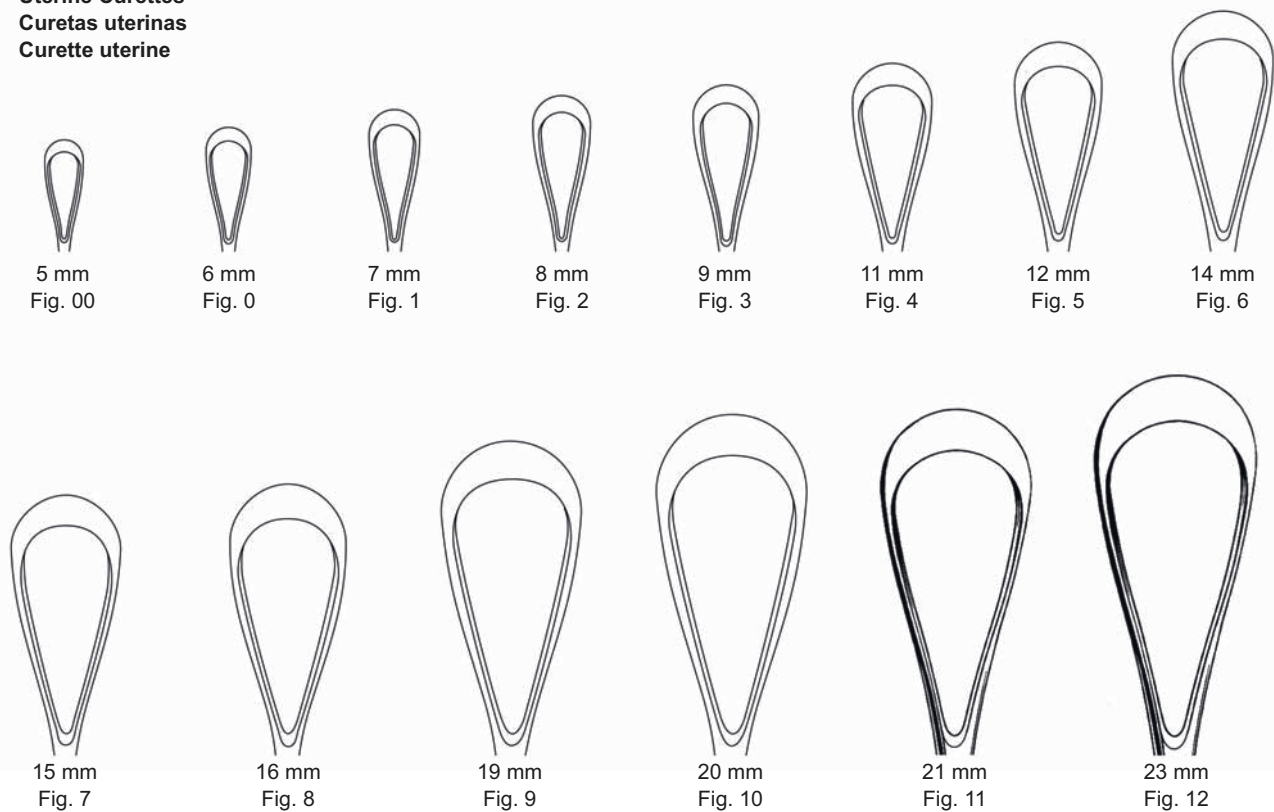

scharf, feAK  
sharp, rigid  
coAKantes, rígidas  
acute, rigide

Fig. 00	GO-1710-05
Fig. 0	GO-1710-06
Fig. 1	GO-1710-07
Fig. 2	GO-1710-08
Fig. 3	GO-1710-09
Fig. 4	GO-1710-11
Fig. 5	GO-1710-12
Fig. 6	GO-1710-14
Fig. 7	GO-1710-15
Fig. 8	GO-1710-16
Fig. 9	GO-1710-19
Fig. 10	GO-1710-20
Fig. 11	GO-1710-21
Fig. 12	GO-1710-23

**RECAMIER**  
31,0 cm, 12¼"



scharf, biegsam  
sharp, malleable  
coAKantes, maleable  
acute, malleabile

Fig. 00	GO-1711-05
Fig. 0	GO-1711-06
Fig. 1	GO-1711-07
Fig. 2	GO-1711-08
Fig. 3	GO-1711-09
Fig. 4	GO-1711-11
Fig. 5	GO-1711-12
Fig. 6	GO-1711-14
Fig. 7	GO-1711-15
Fig. 8	GO-1711-16
Fig. 9	GO-1711-19
Fig. 10	GO-1711-20
Fig. 11	GO-1711-21
Fig. 12	GO-1711-23

**RECAMIER**  
31,0 cm, 12¼"



**Uterusküretten  
Uterine Curettes  
Curetas uterinas  
Curette uterine**

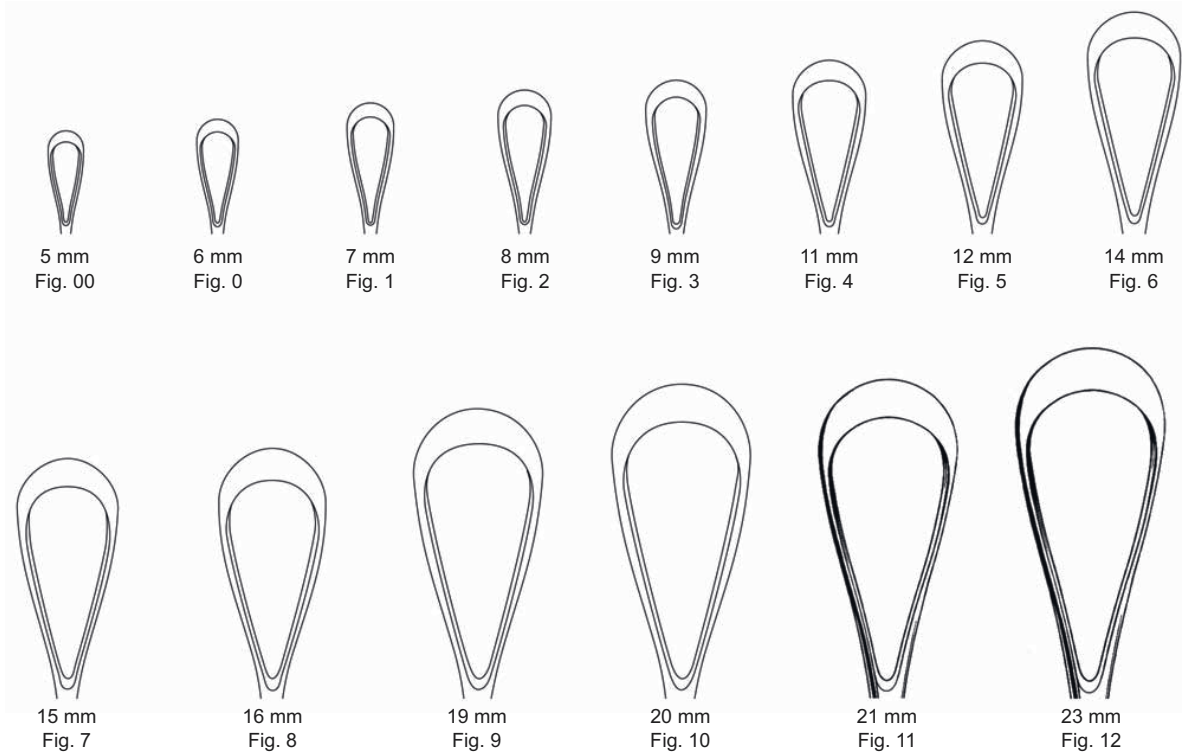

scharf, feAK  
sharp, rigid  
coAKantes, rígidas  
acute, rigide

Fig. 00	GO-1712-05
Fig. 0	GO-1712-06
Fig. 1	GO-1712-07
Fig. 2	GO-1712-08
Fig. 3	GO-1712-09
Fig. 4	GO-1712-11
Fig. 5	GO-1712-12
Fig. 6	GO-1712-14
Fig. 7	GO-1712-15
Fig. 8	GO-1712-16
Fig. 9	GO-1712-19
Fig. 10	GO-1712-20
Fig. 11	GO-1712-21
Fig. 12	GO-1712-23

**SIMS**  
31,0 cm, 12¼"



scharf, biegsam  
sharp, malleable  
coAKantes, maleable  
acute, malleabile

Fig. 00	GO-1713-05
Fig. 0	GO-1713-06
Fig. 1	GO-1713-07
Fig. 2	GO-1713-08
Fig. 3	GO-1713-09
Fig. 4	GO-1713-11
Fig. 5	GO-1713-12
Fig. 6	GO-1713-14
Fig. 7	GO-1713-15
Fig. 8	GO-1713-16
Fig. 9	GO-1713-19
Fig. 10	GO-1713-20
Fig. 11	GO-1713-21
Fig. 12	GO-1713-23

**SIMS**  
31,0 cm, 12¼"





**Uterusküretten**  
**Uterine Curettes**  
**Curetas uterinas**  
**Curette uterine**

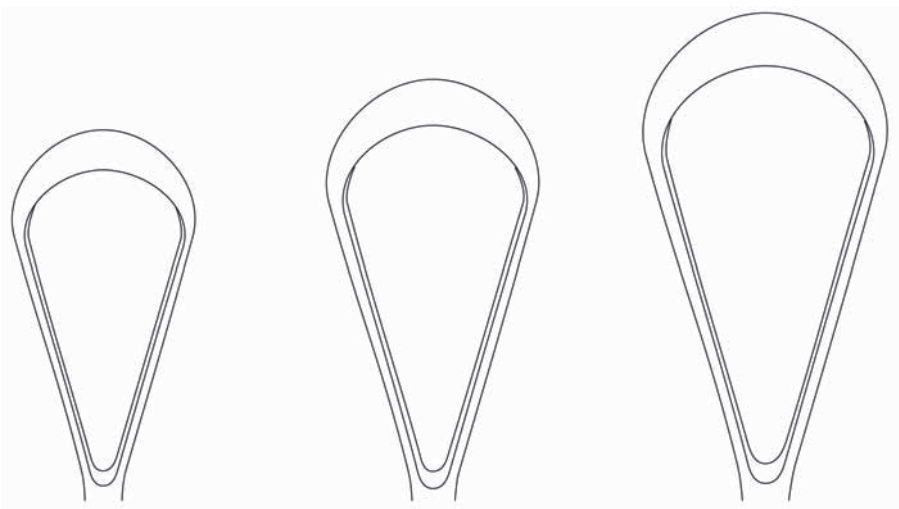

30 mm  
Fig. 1

35 mm  
Fig. 2

40 mm  
Fig. 3



scharf, feAK  
sharp, rigid  
coAKantes, rigidas  
acute, rigide

Fig. 1 **GO-1720-30**  
Fig. 2 **GO-1720-35**  
Fig. 3 **GO-1720-40**

**SIMS**  
31,0 cm, 12<sup>1</sup>/<sub>4</sub>"



scharf, biegsam  
sharp, malleable  
coAKantes, maleable  
acute, malleabile

Fig. 1 **GO-1721-30**  
Fig. 2 **GO-1721-35**  
Fig. 3 **GO-1721-40**

**SIMS**  
31,0 cm, 12<sup>1</sup>/<sub>4</sub>"

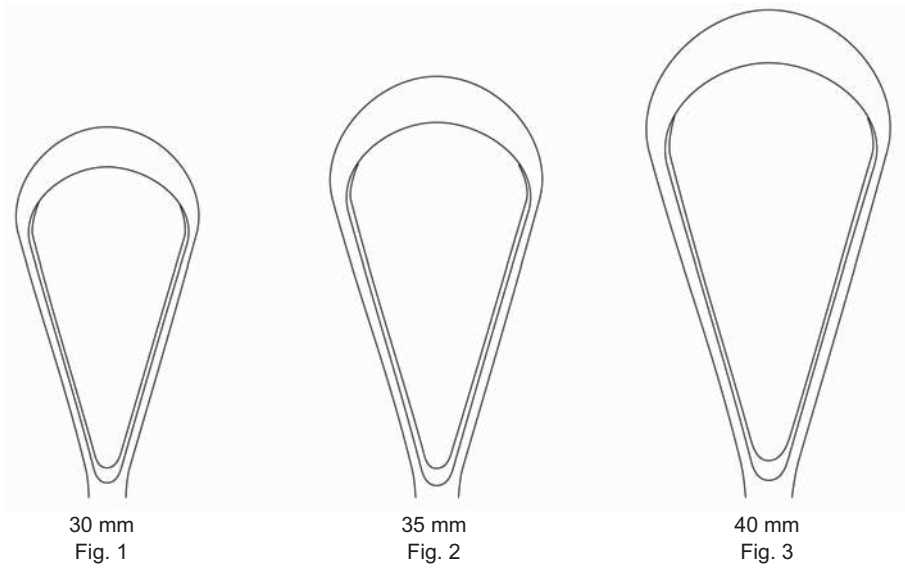

30 mm  
Fig. 1

35 mm  
Fig. 2

40 mm  
Fig. 3



scharf, feAK  
sharp, rigid  
coAKantes, rigidas  
acute, rigide

Fig. 1 **GO-1722-30**  
Fig. 2 **GO-1722-35**  
Fig. 3 **GO-1722-40**

**BUMM**  
31,0 cm, 12<sup>1</sup>/<sub>4</sub>"



scharf, biegsam  
sharp, malleable  
coAKantes, maleable  
acute, malleabile

Fig. 1 **GO-1723-30**  
Fig. 2 **GO-1723-35**  
Fig. 3 **GO-1723-40**

**BUMM**  
31,0 cm, 12<sup>1</sup>/<sub>4</sub>"



**Uteruslöffel, Uterus-Biopsiezangen**  
**Uterine Scoopes, Cervical Biopsy and Specimen Forceps**  
**Cucharillas uterinas, Pinzas saca-bocados para biopsia**  
**Curette uterine, Pinze per la biopsia cervicale e da prelievo**



**BLAKE**  
27,0 cm, 10<sup>5</sup>/<sub>8</sub>"  
GO-1750-27



**SIMON**  
25,0 cm, 9<sup>3</sup>/<sub>4</sub>"

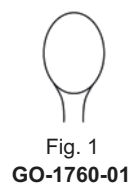

Fig. 1  
GO-1760-01

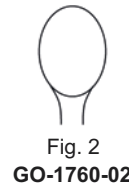

Fig. 2  
GO-1760-02

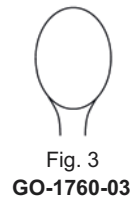

Fig. 3  
GO-1760-03



Fig. 4  
GO-1760-04



Fig. 5  
GO-1760-05



Fig. 6  
GO-1760-06

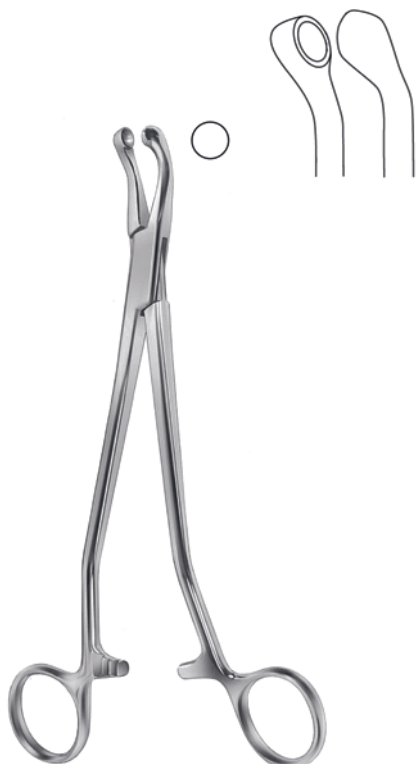

**THOMS-GAYLOR**  
22,0 cm, 8<sup>5</sup>/<sub>8</sub>" GO-1680-22  
24,0 cm, 9<sup>1</sup>/<sub>2</sub>" GO-1680-24

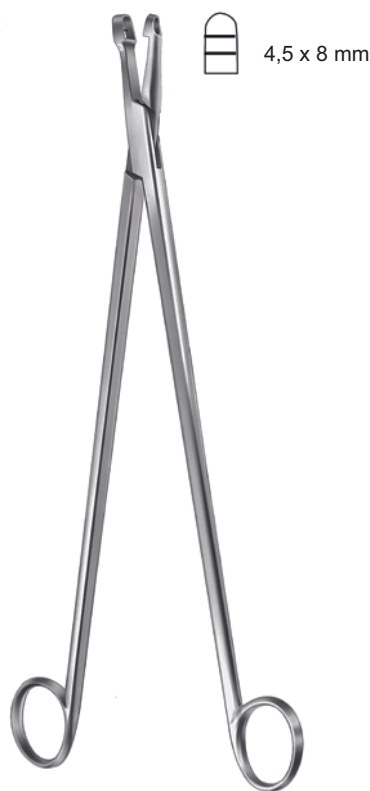

**SCHUBEAK**  
21,0 cm, 8<sup>1</sup>/<sub>4</sub>" GO-1682-21  
29,0 cm, 11<sup>1</sup>/<sub>2</sub>" GO-1682-29



**SCHUMACHER-VAN DOREN**  
24,0 cm, 9<sup>1</sup>/<sub>2</sub>"  
GO-1684-24

**Uterus-Biopsiezangen**  
**Cervical Biopsy and Specimen Forceps**  
**Pinzas saca-bocados para biopsia**  
**Pinze per la biopsia cervicale e da prelievo**



**THOMS-GAYLOR**  
24,0 cm, 9 1/2"  
GO-1686-24



**FAURE**  
21,0 cm, 8 1/4"  
GO-1688-21



**SCHUBEAK**  
26,0 cm, 10 1/4"  
GO-1690-26

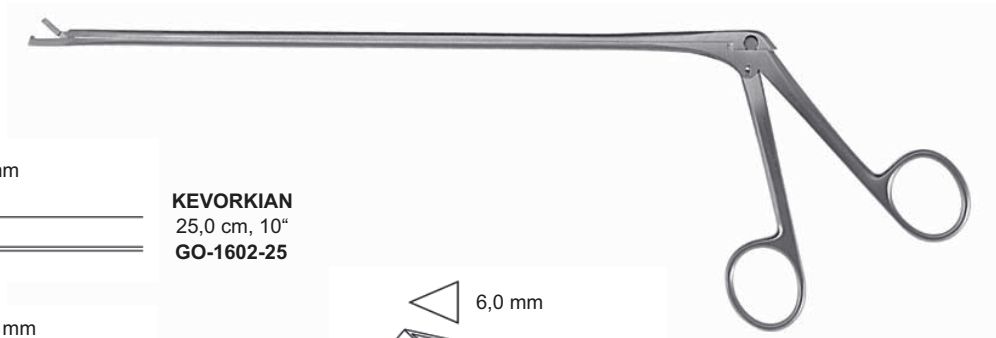

9 x 3 mm



**KEVORKIAN**  
25,0 cm, 10"  
GO-1602-25

4,5 x 8 mm

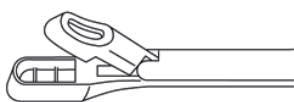

**EPPENDORFER**  
20,0 cm, 8"  
GO-1604-20

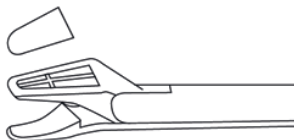

**ALEXANDER**  
28,0 cm, 11"  
GO-1608-28

4,0 mm

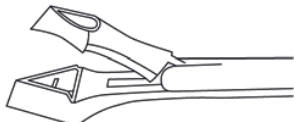

**SCHUMACHER**  
24,0 cm, 9 1/2"  
GO-1610-04

6,0 mm

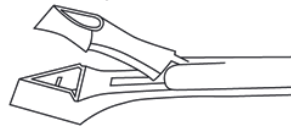

**SCHUMACHER**  
24,0 cm, 9 1/2"  
GO-1610-06

4,5 x 8 mm



**WITTNER**  
23,0 cm, 9"  
GO-1615-23

4,5 x 8 mm



**WITTNER**  
23,0 cm, 9"  
GO-1614-23



**Uterus-Biopsiezangen**  
**Cervical Biopsy and Specimen Forceps**  
**Pinzas saca-bocados para biopsia**  
**Pinze per la biopsia cervicale e da prelievo**

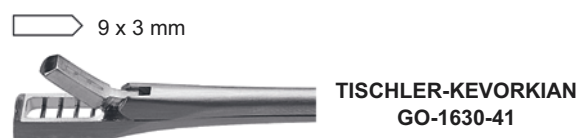
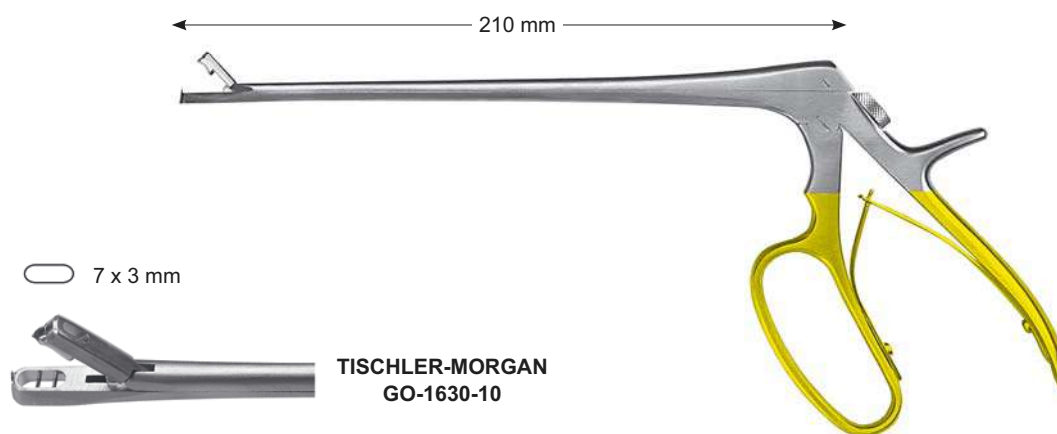
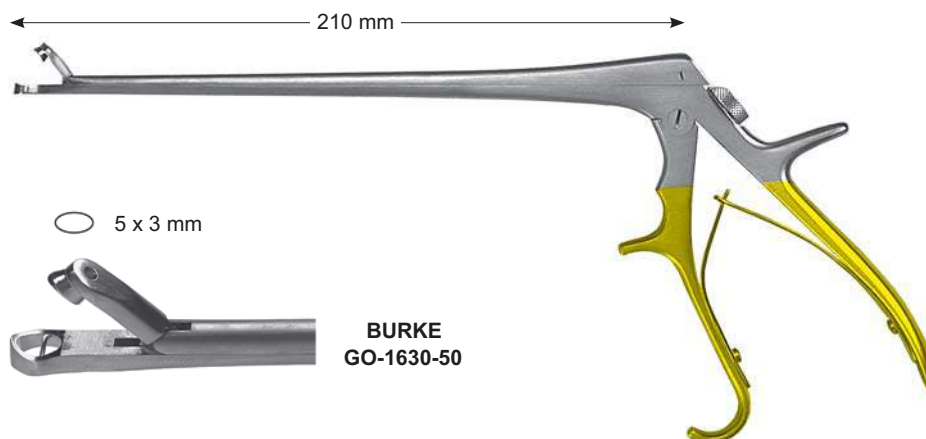



GebuAAKzangen  
ObAKetrical Forceps  
Fórceps para obAKétrica  
Forbici per oAKetricia



**WRIGLEY**  
28,0 cm, 11"  
GO-1056-28



**SIMPSON**  
30,0 cm, 11<sup>3</sup>/<sub>4</sub>"  
GO-134-30



**SIMPSON-BRAUN**  
33,0 cm, 13"  
GO-136-33



**SIMPSON-BRAUN**  
36,0 cm, 14<sup>1</sup>/<sub>8</sub>"  
GO-1036-36



**SIMPSON-LUIKAAK**  
36,0 cm, 14<sup>1</sup>/<sub>8</sub>"  
GO-1046-36



**DE LEE**  
30,0 cm, 11<sup>3</sup>/<sub>4</sub>"  
GO-1058-30



**DE LEE**  
36,0 cm, 14<sup>1</sup>/<sub>8</sub>"  
GO-1058-36



**DE LEE**  
38,0 cm, 15<sup>3</sup>/<sub>8</sub>"  
GO-1058-38



GebuAAKzangen  
ObAKetrical Forceps  
Fórceps para obAKétrica  
Forbici per oAKetricia



**MC LEAN**  
36,0 cm, 14<sup>1</sup>/<sub>8</sub>"  
058-1044-36



**KIELAND**  
41,0 cm, 16"  
GO-1052-41



**KIELAND-LUIKAAK**  
40,0 cm, 15<sup>3</sup>/<sub>4</sub>"  
GO-1054-40



**PIPER**  
44,0 cm, 17<sup>1</sup>/<sub>4</sub>"  
GO-1060-44



**ELLIOT**  
32,0 cm, 12<sup>1</sup>/<sub>2</sub>"  
058-1080-32



**ELLIOT**  
38,0 cm, 15"  
GO-1080-38



**NAEGELE**  
36,0 cm, 14<sup>1</sup>/<sub>8</sub>"  
GO-1084-36



**NAEGELE**  
40,0 cm, 15<sup>3</sup>/<sub>4</sub>"  
GO-1084-40



GebuAAKzangen, Plazentar- und AboAKuzangen  
ObAKetrical Forceps, Placenta and Ovum Forceps  
Fórceps para obAKétrica, Pinzas para aboAKo y placenta  
Forbici per oAKetricia, Pinze per placenta e per ovaie

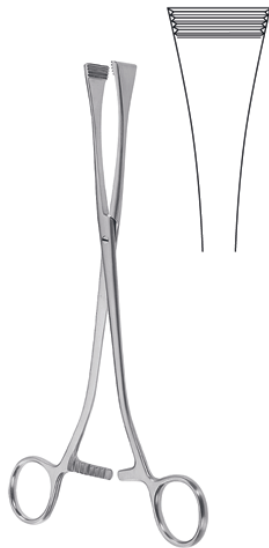

**GREEN-ARMYTAGE**  
21,0 cm, 8<sup>1</sup>/<sub>4</sub>"  
058-1200-21



**PEAKALOZZA**  
30,0 cm, 11<sup>3</sup>/<sub>4</sub>"  
GO-1252-30



**SAENGER**  
27,0 cm, 10<sup>5</sup>/<sub>8</sub>"  
GO-1260-27



**SAENGER**  
27,0 cm, 10<sup>5</sup>/<sub>8</sub>"  
GO-1261-27



**WINTER**  
28,0 cm, 11"



Fig. 1  
GO-1244-01



Fig. 2  
GO-1244-02



Fig. 3  
GO-1244-03



Fig. 1  
GO-1245-01



Fig. 2  
GO-1245-02

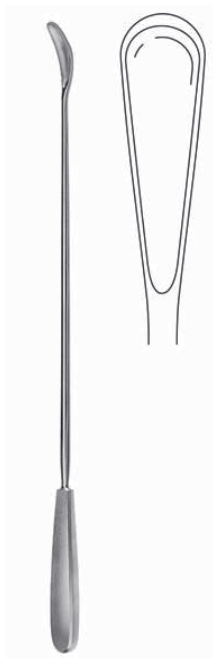

Fig. 3  
GO-1245-03





**Plazentar- und AboAKuzangen**  
**Placenta and Ovum Forceps**  
**Pinzas para aboAKo y placenta**  
**Pinze per placenta e per ovaie**



**WALLICH**  
42,0 cm, 16 $\frac{1}{2}$ "  
GO-1300-42



**MAAKIN**  
34,0 cm, 13 $\frac{3}{8}$ "  
GO-1600-34



**BIERER**  
33,0 cm, 13"  
GO-1236-01



**BIERER**  
33,0 cm, 13"  
GO-1236-02



**BIERER**  
33,0 cm, 13"  
GO-1237-01



**BIERER**  
33,0 cm, 13"  
GO-1237-02



**VASE** INSTRUMENTS  
PREMIUM QUALITY INSTRUMENTS

**Vorbereitung, Dermatologie**  
**Preparation, Dermatology**  
**Preparación, Dermatología**  
**Preparazione, Dermatalogia**





**HautAKanzen, Nagel InAKrumente**  
**Dermal Punches, Nail InAKruments**  
**Trépanos cutáneos, InAKrumentos para uñas**  
**Trapani dermatici, AKrumenti per unghie**



**PIFFARD**  
14,0 cm, 5<sup>3</sup>/<sub>4</sub>"

Lupusküretten  
Lupus curettes  
Curetas para lupus  
Raschiatoio per lupus



**KEYES**  
12,0 cm, 4<sup>3</sup>/<sub>4</sub>"

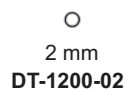

**KEYES**  
12,0 cm, 4<sup>3</sup>/<sub>4</sub>"  
**DT-1210-00**

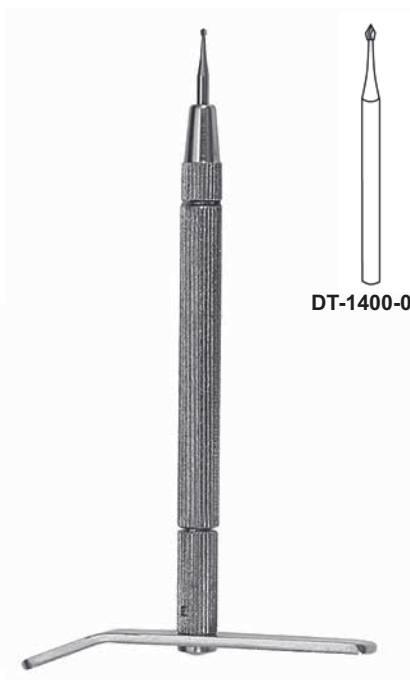

**NAGELBOHRER**  
**DT-1400-00**  
komplett, complete,  
completo, completo

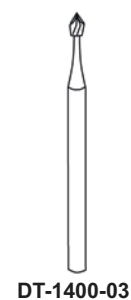
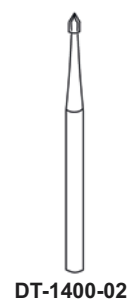
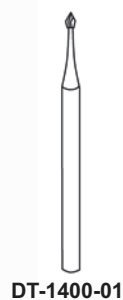



**Komedonenquetscher  
Comedo ExtraAKors  
Saca-comedones  
Tiracomedoni**



**UNNA**  
14,0 cm, 5<sup>3</sup>/<sub>4</sub>"  
DT-000-14



**UNNA**  
14,0 cm, 5<sup>3</sup>/<sub>4</sub>"  
DT-1002-14



**SAALFELD**  
10,0 cm, 4"  
DT-1010-10



**SAALFELD**  
14,0 cm, 5<sup>3</sup>/<sub>4</sub>"  
DT-1012-14



**SCHAMBERG**  
10,0 cm, 4"  
DT-1020-10



**WALTON**  
14,0 cm, 5<sup>3</sup>/<sub>4</sub>"  
DT-1030-14



**FOX**  
14,0 cm, 5<sup>3</sup>/<sub>4</sub>"



Lupusküretten  
Lupus curettes  
Curetas para lupus  
Raschiatoio per lupus



**Nagel InAKrumente**  
**Nail InAKruments**  
**InAKruments para uñas**  
**AKrumenti per unghie**



**FINGERRINGSÄGE**  
17,0 cm, 6<sup>3</sup>/<sub>4</sub>"  
DT-1420-17



**WALTON**  
16,0 cm, 6<sup>1</sup>/<sub>4</sub>"  
DT-1430-16



**RADOLF**  
13,5 cm, 5<sup>3</sup>/<sub>8</sub>"  
DT-1500-13



**NAGELZANGE**  
13,5 cm, 5<sup>3</sup>/<sub>8</sub>"  
DT-1510-13



**NAGELZANGE**  
13,0 cm, 5"  
DT-1600-13



**NAGELZANGE**  
14,0 cm, 5<sup>1</sup>/<sub>2</sub>"



**VASE** INSTRUMENTS  
PREMIUM QUALITY INSTRUMENTS

**Knochenchirurgie**  
**Bone Surgery**  
**Cirurgía ósea**  
**Chirurgia ossea**





**Scharfe Löffel**  
**Bone Curettes**  
**Cucharillas coA Kantes**  
**Curetta per ossa**



Fig. 0000  
**AK-1469-04**



Fig. 0000  
**AK-1472-04**



Fig. 000  
**AK-1469-03**



Fig. 000  
**AK-1472-03**



Fig. 00  
**AK-1469-02**



Fig. 00  
**AK-1472-02**



Fig. 000  
**AK-1467-03**



Fig. 0  
**AK-1469-01**



Fig. 0  
**AK-1472-01**



Fig. 00  
**AK-1467-02**



Fig. 1  
**AK-1469-11**



Fig. 1  
**AK-1472-11**



Fig. 0  
**AK-1467-01**



Fig. 2  
**AK-1469-12**



Fig. 2  
**AK-1472-12**



Fig. 0  
**AK-1467-01**



Fig. 3  
**AK-1469-13**



Fig. 3  
**AK-1472-13**



Fig. 1  
**AK-1467-11**



Fig. 4  
**AK-1469-14**



Fig. 4  
**AK-1472-14**



Fig. 2  
**AK-1467-12**



Fig. 5  
**AK-1469-15**



Fig. 5  
**AK-1472-15**



Fig. 3  
**AK-1467-13**



Fig. 6  
**AK-1469-16**



Fig. 6  
**AK-1472-16**



Fig. 4  
**AK-1467-14**



**SCHEDÉ**  
17,0 cm, 6<sup>3</sup>/<sub>4</sub>"



**VOLKMANN**  
17,0 cm, 6<sup>3</sup>/<sub>4</sub>"



**BRUNS**  
17,0 cm, 6<sup>3</sup>/<sub>4</sub>"

Fig. 00000  
**AK-1448-04**

Fig. 0000  
**AK-1448-03**

Fig. 000  
**AK-1448-02**

Fig. 00  
**AK-1448-01**

Fig. 0  
**AK-1448-00**



**LEMPEAK**  
21,5 cm, 8½"



**HALLE**  
21,0 cm, 8¼"

Fig. 00  
**AK-1452-02**

Fig. 0  
**AK-1452-01**

Fig. 1  
**AK-1452-11**



**DAUBENSPECK**  
20,0 cm, 8"

Fig. 00  
**AK-1487-02**

Fig. 0  
**AK-1487-01**

Fig. 1  
**AK-1487-11**

Fig. 2  
**AK-1487-12**





**Scharfe Löffel**  
**Bone Curettes**  
**Cucharillas coAKantes**  
**Curetta per ossa**



Fig. 1  
**AK-1430-11**

Fig. 2  
**AK-1430-12**

**WILLIGER**  
17,0 cm, 6<sup>3</sup>/<sub>4</sub>"



Fig. 0  
**AK-1406-00**

Fig. 1  
**AK-1406-01**

**WILLIGER**  
14,0 cm, 5<sup>1</sup>/<sub>2</sub>"

Fig. 2  
**AK-1406-02**



Fig. 00/0  
**AK-1408-00**  
14,0 cm, 5<sup>1</sup>/<sub>2</sub>"

Fig. 0/1  
**AK-1408-01**  
14,0 cm, 5<sup>1</sup>/<sub>2</sub>"

Fig. 1/2  
**AK-1408-12**  
14,0 cm, 5<sup>1</sup>/<sub>2</sub>"

**MAAKINI**  
14,0 cm, 5<sup>1</sup>/<sub>2</sub>"  
**AK-1408-00**



**VOLKMANN**

**AK-1414-13**  
13,0 cm, 5"

**AK-1414-14**  
14,0 cm, 5<sup>1</sup>/<sub>2</sub>"

**AK-1414-17**  
17,0 cm, 6<sup>3</sup>/<sub>4</sub>"



**JANSEN**  
15,0 cm, 6"  
**AK-1411-15**



**JANSEN**  
16,0 cm, 6<sup>1</sup>/<sub>4</sub>"  
**AK-1410-16**

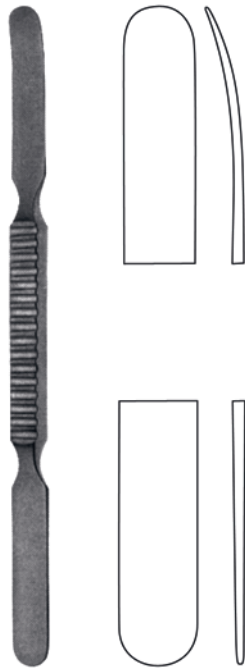

**WATSON-CHEYNE**  
17,5 cm, 6<sup>5</sup>/<sub>8</sub>"  
AK-1501-17



**MC DONALD**  
19,0 cm, 7<sup>1</sup>/<sub>2</sub>"  
AK-1440-19



**WILLIGER**  
17,0 cm, 6<sup>3</sup>/<sub>4</sub>"  
AK-1512-17

Dissektoren, Elevatorien  
DisseAKors, Elecators  
Disecadores, Elevadores  
Dissettori, Elevatori



**WILLIGER**  
16,0 cm, 6<sup>1</sup>/<sub>4</sub>"  
AK-1512-16



**LANGENBECK**  
20,0 cm, 8"  
AK-1520-08



**LANGENBECK**  
20,0 cm, 8"  
AK-1520-10



Raspatorien  
Raspatories  
PerioAKótomos  
PerioAKotomi



1

**ADSON**



8 mm  
**063-1465-01**



7 mm  
**AK-1465-02**



7 mm  
**AK-1465-03**



7 mm  
**AK-1465-04**

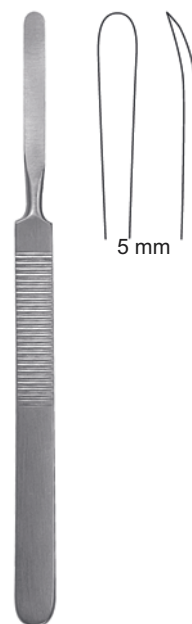

1

**AK-1476-15**

5 mm



**LAMBOTTE**  
21,0 cm, 8 1/4"



10 mm  
**AK-1477-10**



15 mm  
**AK-1477-15**

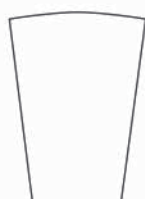

20 mm  
**AK-1477-20**

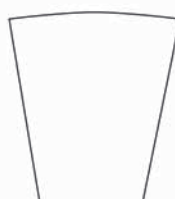

25 mm  
**AK-1477-25**

12,5 mm



**FARABEUF**  
15,0 cm, 6"  
**AK-1478-15**





15,0 mm

**Raspatorien**  
**Raspatories**  
**PerioAKótomos**  
**PerioAKotomi**

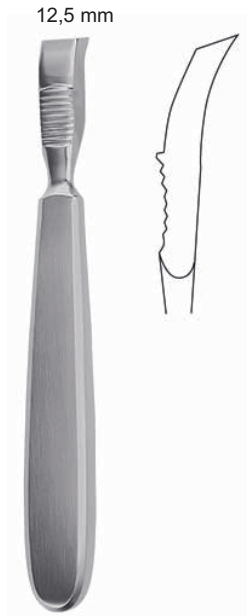

**FARABEUF**  
15,0 cm, 6"  
063-1479-15



**LANGENBECK**  
19,0 cm, 7 1/2"  
AK-1472-19



**SEDILLOT**  
21,0 cm, 8 1/4"  
AK-1488-21



**WILLIGER**  
16,0 cm, 6 1/4"

4 mm **AK-1480-04**  
6 mm **AK-1480-06**  
8 mm **AK-1480-08**



für Kinder  
for children  
para niños  
per bambini

**DOYEN**  
17,0 cm, 6 3/4"  
063-1485-17



für Kinder  
for children  
para niños  
per bambini

**DOYEN**  
17,0 cm, 6 3/4"  
AK-1487-17



für Erwachsene  
for adults  
para adultos  
per adulti

**DOYEN**  
17,0 cm, 6 3/4"  
AK-1481-17



für Erwachsene  
for adults  
para adultos  
per adulti

**DOYEN**  
17,0 cm, 6 3/4"  
AK-1485-17



Flachmeißel, Hohlmeißel, OAKeotome  
Chisels, Gouges, OAKeotomes  
Cinceles, Gubias, OAKeótomos  
ScalPELLi, Sgorbie, OAKeotomi



8,0 mm	<b>AK-1300-08</b>
10,0 mm	<b>AK-1300-10</b>
12,0 mm	<b>AK-1300-12</b>
14,0 mm	<b>AK-1300-14</b>
16,0 mm	<b>AK-1300-16</b>

13,5 cm, 5<sup>3</sup>/<sub>8</sub>"



8,0 mm	<b>AK-1301-08</b>
10,0 mm	<b>AK-1301-10</b>
12,0 mm	<b>AK-1301-12</b>
14,0 mm	<b>AK-1301-14</b>
16,0 mm	<b>AK-1301-16</b>

13,5 cm, 5<sup>3</sup>/<sub>8</sub>"



8,0 mm	<b>AK-1302-08</b>
10,0 mm	<b>AK-1302-10</b>
12,0 mm	<b>AK-1302-12</b>
14,0 mm	<b>AK-1302-14</b>
16,0 mm	<b>AK-1302-16</b>

13,5 cm, 5<sup>3</sup>/<sub>8</sub>"



3,0 mm	<b>AK-1334-03</b>
4,0 mm	<b>AK-1334-04</b>
5,0 mm	<b>AK-1334-05</b>
6,0 mm	<b>AK-1334-06</b>

**PAAAKCH**  
13,5 cm, 5<sup>3</sup>/<sub>8</sub>"



3,0 mm	<b>AK-1336-03</b>
4,0 mm	<b>AK-1336-04</b>
5,0 mm	<b>AK-1336-05</b>
6,0 mm	<b>AK-1336-06</b>

**PAAAKCH**  
13,5 cm, 5<sup>3</sup>/<sub>8</sub>"



10,0 mm	<b>AK-1361-10</b>
15,0 mm	<b>AK-1361-15</b>
20,0 mm	<b>AK-1361-20</b>
25,0 mm	<b>AK-1361-25</b>

**AKILLE**  
20,0 cm, 8"

Flachmeißel, Hohlmeißel, OAKEotome  
Chisels, Gouges, OAKEotomes  
Cinceles, Gubias, OAKEótomos  
Scalpelli, Sgorbie, OAKEotomi



10,0 mm	<b>AK-1360-10</b>
15,0 mm	<b>AK-1360-15</b>
20,0 mm	<b>AK-1360-20</b>
25,0 mm	<b>AK-1360-25</b>

**AKILLE**  
20,0 cm, 8"



10,0 mm	<b>AK-1362-10</b>
15,0 mm	<b>AK-1362-15</b>
20,0 mm	<b>AK-1362-20</b>
25,0 mm	<b>AK-1362-25</b>

**AKILLE**  
20,0 cm, 8"



4,0 mm	<b>AK-1318-04</b>
6,0 mm	<b>AK-1318-06</b>
8,0 mm	<b>AK-1318-08</b>
10,0 mm	<b>AK-1318-10</b>
12,0 mm	<b>AK-1318-12</b>
14,0 mm	<b>AK-1318-14</b>

**ALEXANDER**  
18,0 cm, 7"



4,0 mm	<b>AK-1319-04</b>
6,0 mm	<b>AK-1319-06</b>
8,0 mm	<b>AK-1319-08</b>
10,0 mm	<b>AK-1319-10</b>
12,0 mm	<b>AK-1319-12</b>
14,0 mm	<b>AK-1319-14</b>

**ALEXANDER**  
18,0 cm, 7"



6,0 mm	<b>AK-1350-06</b>
9,0 mm	<b>AK-1350-09</b>
13,0 mm	<b>AK-1350-13</b>
16,0 mm	<b>AK-1350-16</b>
19,0 mm	<b>AK-1350-19</b>
25,0 mm	<b>AK-1350-25</b>
32,0 mm	<b>AK-1350-32</b>

**SMITH-PETERSEN**  
20,0 cm, 8"



6,0 mm	<b>AK-1351-06</b>
9,0 mm	<b>AK-1351-09</b>
13,0 mm	<b>AK-1351-13</b>
16,0 mm	<b>AK-1351-16</b>
19,0 mm	<b>AK-1351-19</b>
25,0 mm	<b>AK-1351-25</b>
32,0 mm	<b>AK-1351-32</b>

**SMITH-PETERSEN**  
20,0 cm, 8"



Flachmeißel, Hohlmeißel, OAKeotome, Hämmer  
Chisels, Gouges, OAKeotomes, Mallets  
Cinceles, Gubias, OAKeótomos, MaAKillos  
ScalPELLi, Sgorbie, OAKeotomi, MaAKelli



9,0 mm	<b>AK-1352-09</b>
14,0 mm	<b>AK-1352-14</b>
16,0 mm	<b>AK-1352-16</b>
19,0 mm	<b>AK-1352-19</b>
25,0 mm	<b>AK-1352-25</b>

**SMITH-PETERSEN**  
20,0 cm, 8"



9,0 mm	<b>AK-1353-09</b>
14,0 mm	<b>AK-1353-14</b>
16,0 mm	<b>AK-1353-16</b>
19,0 mm	<b>AK-1353-19</b>
25,0 mm	<b>AK-1353-25</b>

**SMITH-PETERSEN**  
20,0 cm, 8"



6,0 mm	<b>AK-1450-06</b>
15,0 mm	<b>AK-1450-15</b>
20,0 mm	<b>AK-1450-20</b>
25,0 mm	<b>AK-1450-25</b>
30,0 mm	<b>AK-1450-30</b>
38,0 mm	<b>AK-1450-38</b>
44,0 mm	<b>AK-1450-44</b>
50,0 mm	<b>AK-1450-50</b>

**LAMBOTTE**  
24,0 cm, 9 1/2"



6,0 mm	<b>AK-1451-06</b>
15,0 mm	<b>AK-1451-15</b>
20,0 mm	<b>AK-1451-20</b>
25,0 mm	<b>AK-1451-25</b>
30,0 mm	<b>AK-1451-30</b>
38,0 mm	<b>AK-1451-38</b>
44,0 mm	<b>AK-1451-44</b>
50,0 mm	<b>AK-1451-50</b>

**LAMBOTTE**  
24,0 cm, 9 1/2"

Ø 30 mm  
220 g



**COLLIN**  
20,0 cm, 8"  
**AK-1132-20**

Ø 22 mm  
200 g



**PAAAKCH**  
18,0 cm, 7"  
**AK-1145-18**

Ø 45 mm  
300 g



**BERGMANN**  
24,0 cm, 9 1/2"  
**AK-1201-24**

mit Bleifüllung  
lead filled head  
cabezal relleno de plomo  
teAKa di piombo



**VASE** INSTRUMENTS  
PREMIUM QUALITY INSTRUMENTS

**AKerilisation**  
**AKerilization**  
**EAKerilización**  
**AKerilizzazione**







**AKerilisierzangen**  
**AKerilizing Forceps**  
**Pinzas para eAKerilización**  
**Pinze per AKerilizzazione**



20,0 cm, 8"  
**AK-1160-20**



**CHEATTLE**  
27,0 cm, 10<sup>5</sup>/<sub>8</sub>"  
**AK-1163-27**



**ROGGE**  
23,0 cm, 9"  
**AK-1164-23**



**PYE-SMITH (HARRISON)**  
30,0 cm, 12"  
**AK-1166-30**



**MAYO**  
14,0 cm, 5<sup>1</sup>/<sub>2</sub>"  
**AK-1151-14**



**BUNT**  
12,0 cm, 4<sup>3</sup>/<sub>4</sub>"  
**AK-1154-12**



**AKANDZYLINDER**

Ø 75 x 130 mm	<b>AK-1142-06</b>
Ø 75 x 175 mm	<b>AK-1142-07</b>
Ø 100 x 175 mm	<b>AK-1142-08</b>
Ø 100 x 200 mm	<b>AK-1142-09</b>



**RUNDE SCHALE**

Ø 40,0 mm	<b>AK-1130-04</b>
Ø 60,0 mm	<b>AK-1130-06</b>
Ø 80,0 mm	<b>AK-1130-08</b>
Ø 100,0 mm	<b>AK-1130-10</b>
Ø 120,0 mm	<b>AK-1130-12</b>
Ø 150,0 mm	<b>AK-1130-15</b>



**NIERENSCHALE**

170 mm	<b>AK-1140-17</b>
250 mm	<b>AK-1140-25</b>
275 mm	<b>AK-1140-27</b>



**SPÜLSCHALE**

165 x 55 mm	0,75 l	<b>AKI-1133-00</b>
175 x 70 mm	1,00 l	<b>AKI-1133-10</b>
225 x 100 mm	2,00 l	<b>AKI-1133-20</b>
240 x 95 mm	2,75 l	<b>AKI-1133-30</b>
260 x 120 mm	4,00 l	<b>AKI-1133-40</b>
290 x 100 mm	5,00 l	<b>AKI-1133-50</b>
315 x 150 mm	5,50 l	<b>AKI-1133-60</b>
325 x 135 mm	8,00 l	<b>AKI-1133-70</b>
360 x 165 mm	12,00 l	<b>AKI-1133-80</b>
415 x 150 mm	14,00 l	<b>AKI-1133-90</b>



Schalen  
Trays  
Bandejas  
Bacinelle



**INAKRUMENTENKÄAKCHEN**

200 x 150 x 25 mm	<b>AK-1200-01</b>
260 x 180 x 30 mm	<b>AK-1200-02</b>
300 x 220 x 30 mm	<b>AK-1200-03</b>
350 x 220 x 40 mm	<b>AK-1200-04</b>
220 x 170 x 50 mm	<b>AK-1200-05</b>
280 x 200 x 50 mm	<b>AK-1200-06</b>
320 x 240 x 50 mm	<b>AK-1200-07</b>
370 x 270 x 50 mm	<b>AK-1200-08</b>
420 x 320 x 50 mm	<b>AK-1200-09</b>



**NAEDELDOSE**

**AK-1300-00**

Ø 65 x 17 mm

Außen- und Innendose

Exterior and interior box

Caja exterior e interior

Scatola eAKeAKa es interiore

**AK-1300-01**

Ø 62 x 13 mm

Innendose allein

Interior box only

Caja interior, suelta

Scatola interiore sola



**SPÜLSCHALE  
MIT SKALIERUNG**

25 ccm

**AK-310-25**



**SPÜLBECHER  
MIT SKALIERUNG**

50 ccm

**AK-310-50**



# VASE INSTRUMENTS

PREMIUM QUALITY INSTRUMENTS

+92-52-7046105

+92-302-6132711

[www.vaseinstruments.com](http://www.vaseinstruments.com)

[vaseinstruments@gmail.com](mailto:vaseinstruments@gmail.com) | [info@vaseinstruments.com](mailto:info@vaseinstruments.com)

Defence Road, Al Hadi Town, Sialkot - 51310, Pakistan

