

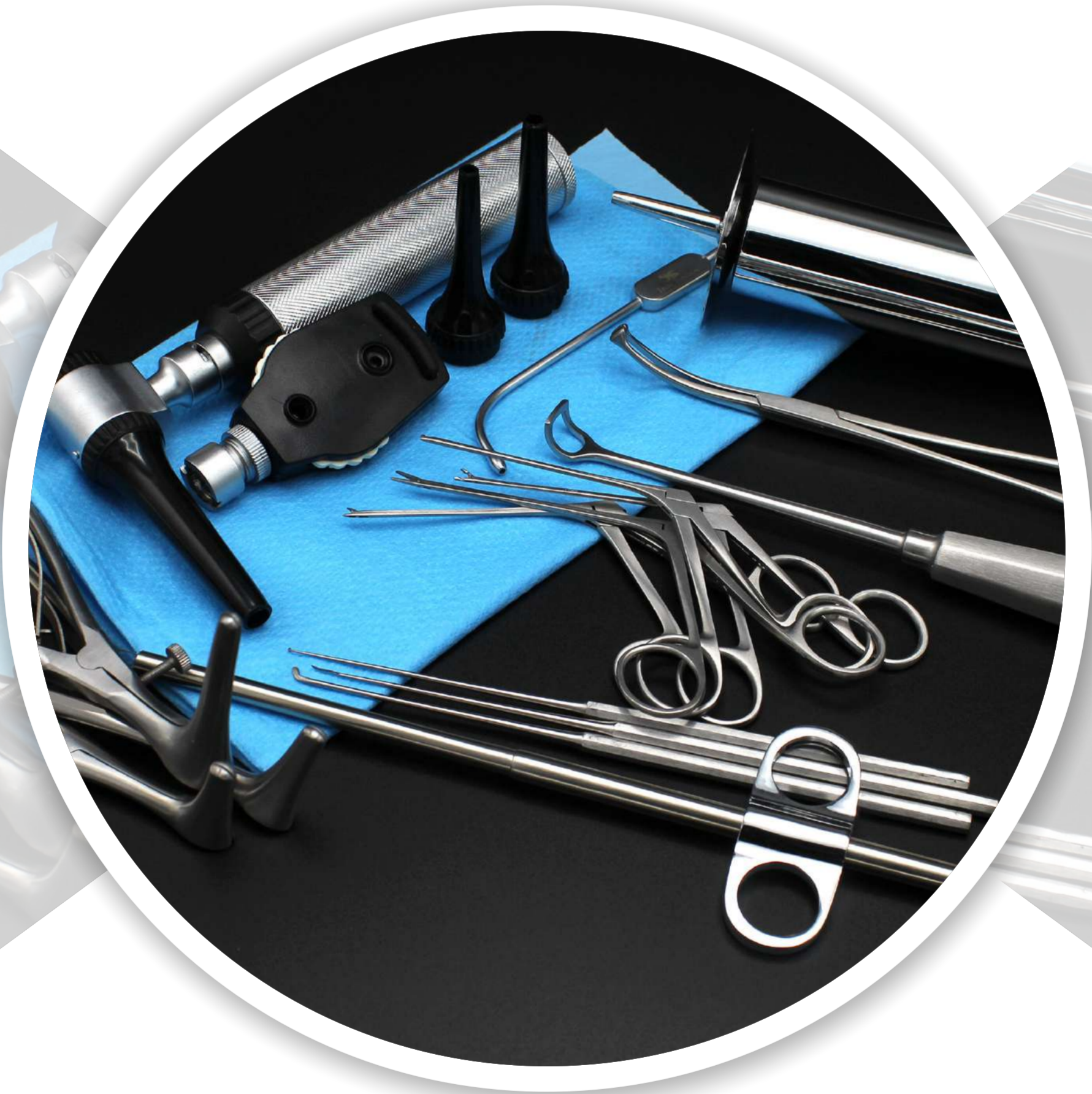

VASE **INSTRUMENTS**
PREMIUM QUALITY INSTRUMENTS



ENT

Instruments Catalogue

www.vaseinstruments.com



VASE INSTRUMENTS
PREMIUM QUALITY INSTRUMENTS

About Us

VASE INSTRUMENTS was established in 2001 and Oldest manufacturer and exporter of vast rang of Instruments. It comprises of an integrated manufacturing facility, employing skilled craftsmen to produce broad range of professional Instruments. Its manufacturing process is running under the supervision of expert technicians.

Management

Skilled employees are its main source for innovation and development of new products. They are working in safe and open environment where every worker contributes continuously to expand the company business. Qualified persons are hired to make use of the progressive technology. The company is also providing active support to its employees to improve their skills, creativity power and social development.

Our Aim

VASE INSTRUMENTS & Company has earned the credit to get the entire satisfaction of the customers. By providing

Quality Products
Fair Prices
Timely Deliveries
Product Range

VASE INSTRUMENTS produces different types of Instruments. Our Main line of the business is General Surgical Instruments, Dental, Plastic Surgery Instruments, ENT Instruments, Gynecology & Ophthalmic Instruments. Each Instrument manufactured by

VASE INSTRUMENTS has personally been supervised and monitored to make sure that the Instruments are perfect. In other words, continuous research and development has allowed this company to make superior quality products.

Quality Standards

VASE INSTRUMENTS has achieved the certification of Sialkot Chamber of Commerce, Surgical Instruments Manufacturer Association Of Pakistan, NTN, CE Mark, ISO 13485-2016. These quality assurance standards are maintained throughout the different production process by its modern testing devices and trained staff which is the main hallmark to maintain the quality of its products.

VASE INSTRUMENTS

C.E.O



VASE **INSTRUMENTS**
PREMIUM QUALITY INSTRUMENTS



ENT

INSTRUMENTS CATALOGUE



VASE **INSTRUMENTS**
PREMIUM QUALITY INSTRUMENTS

Otology

- Ear Polypus Forceps
- Ear Syringes
- Micro Ear Forceps
- Micro Ear Scissors
- Micro Ear Knives
- Micro Ear Hooks
- Micro Ear Needles
- Micro Ear Curettes
- Micro Ear Speculas
- Mastoid Rongeurs
- Tuning Forks



BLACK COATED

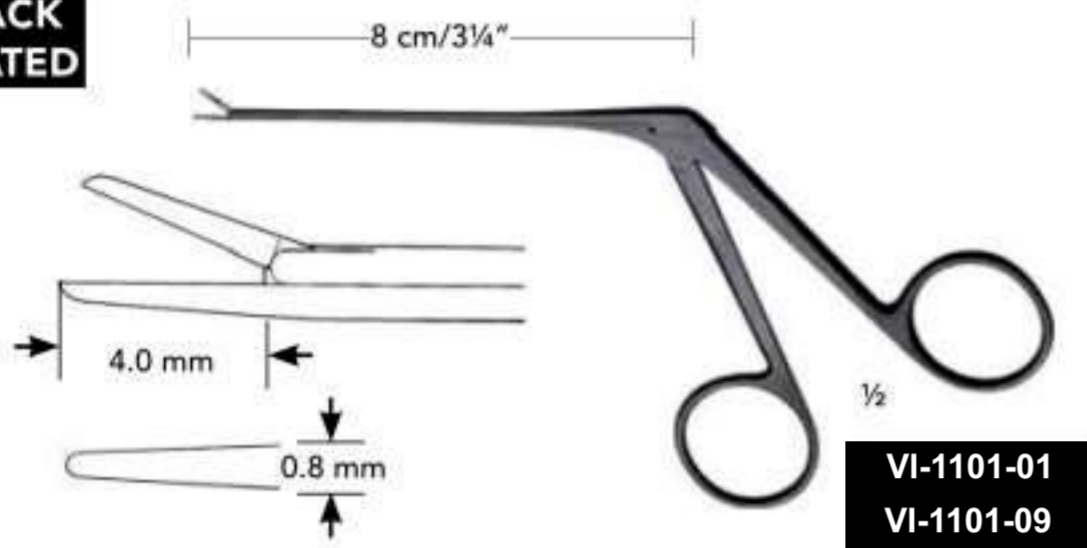

VI-1101-01
VI-1101-09

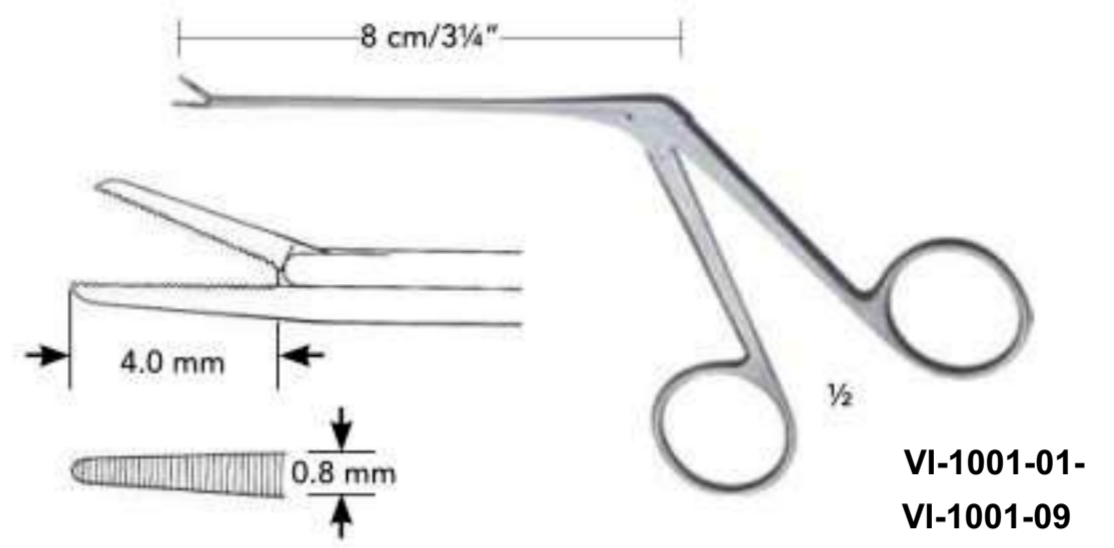

VI-1001-01-
VI-1001-09

Straight, smooth



VI-1001-01

VI-1101-01

Straight, serrated



VI-1001-06

VI-1101-06

Bent upwards, serrated



VI-1001-07

VI-1101-07

Right, serrated



VI-1001-08

VI-1101-08

Left, serrated



VI-1001-09

VI-1101-09

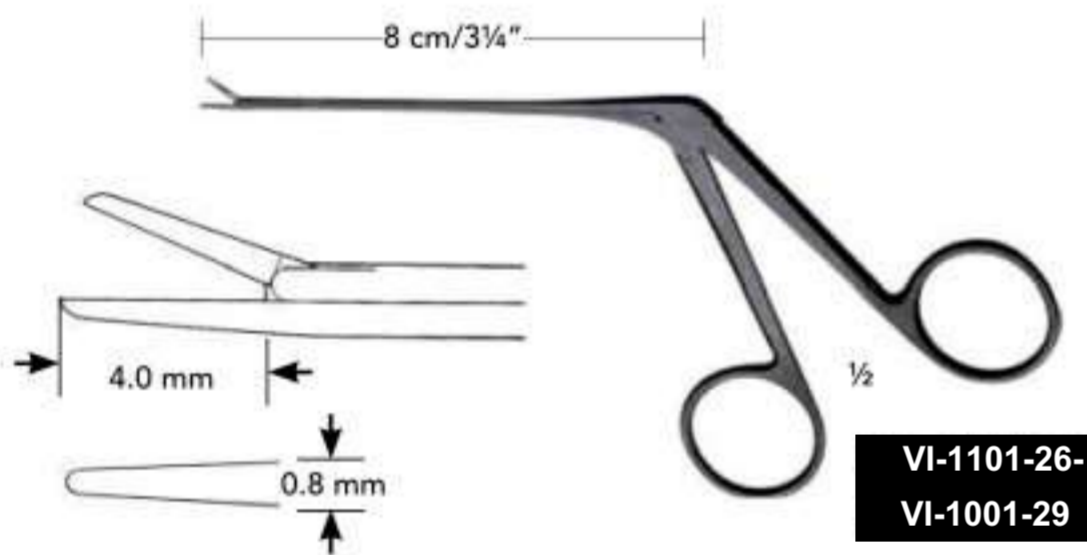

VI-1101-26-
VI-1001-29

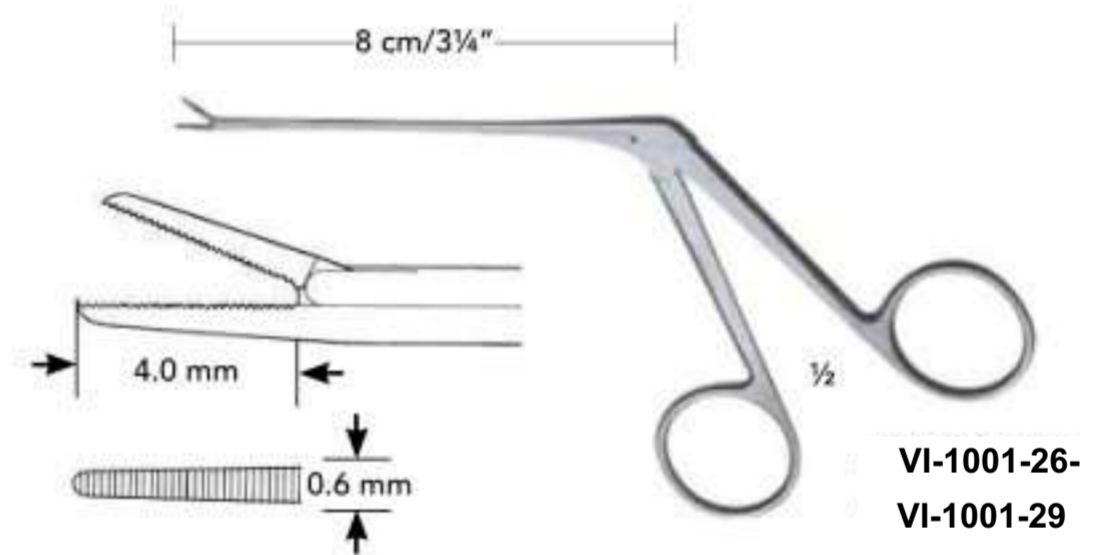

VI-1001-26-
VI-1001-29

Straight, smooth



VI-1001-26

VI-1101-26

Upwards, serrated



VI-1001-27

VI-1101-27

Right, serrated



VI-1001-28

VI-1101-28

Left, serrated



VI-1001-29

VI-1101-29

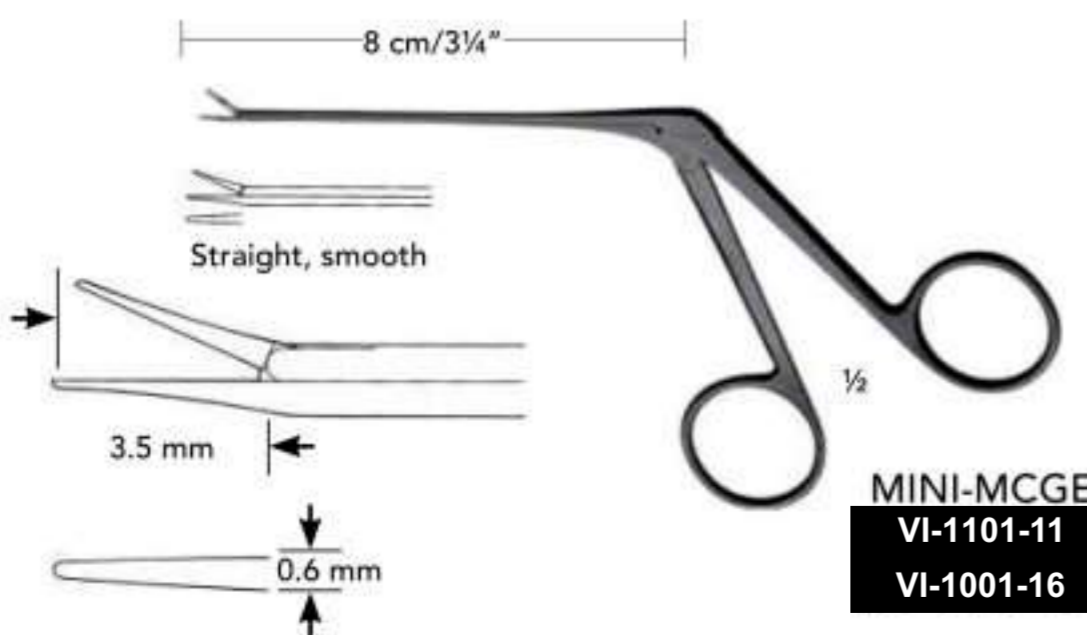

MINI-MCGEE
VI-1101-11
VI-1001-16

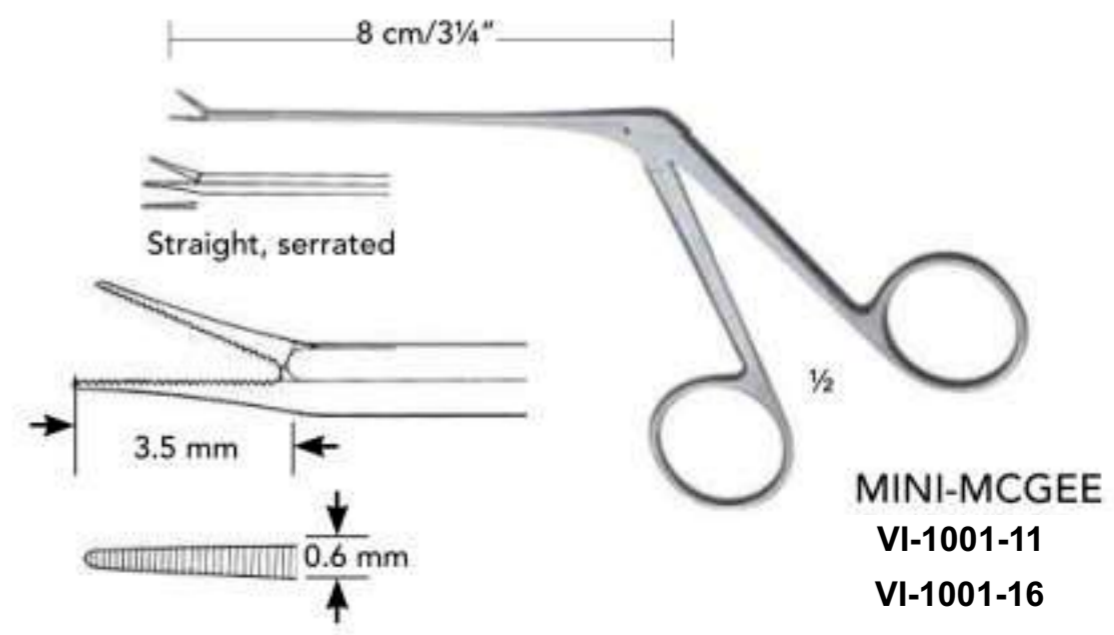

MINI-MCGEE
VI-1001-11
VI-1001-16

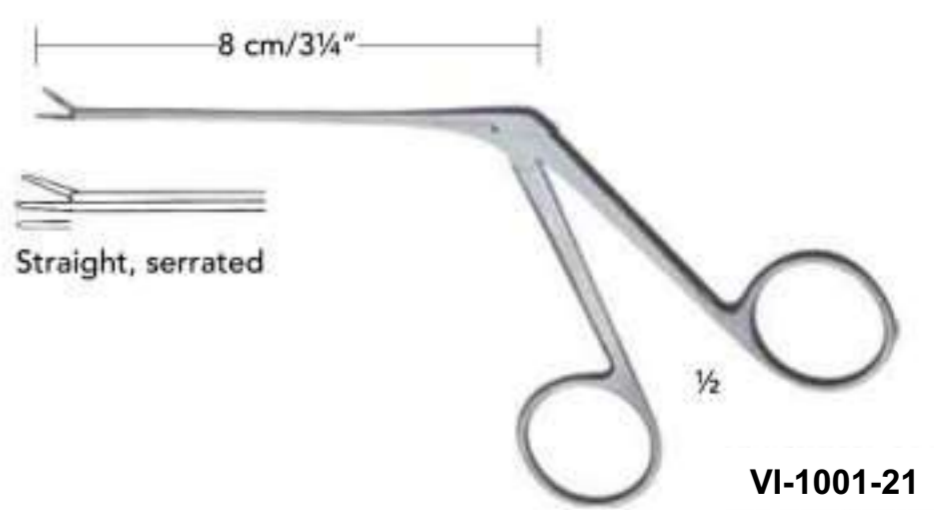
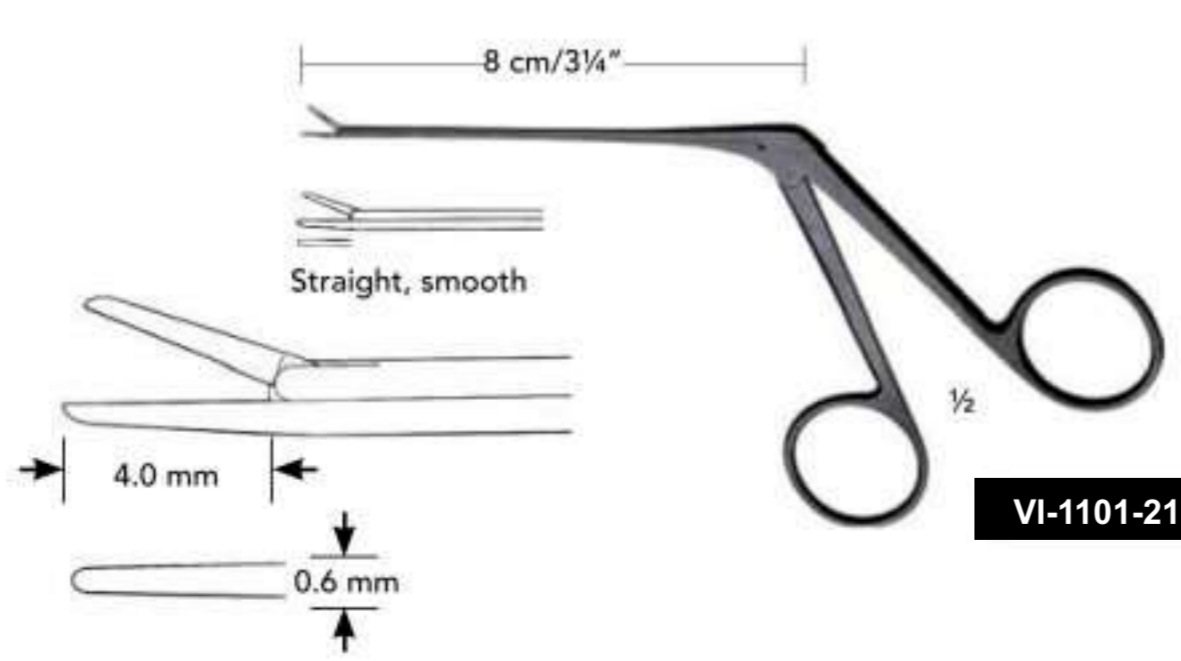
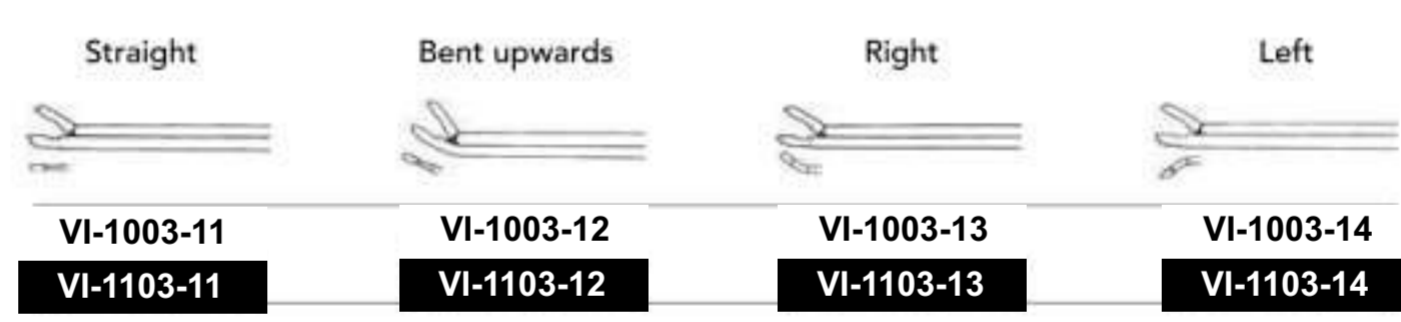
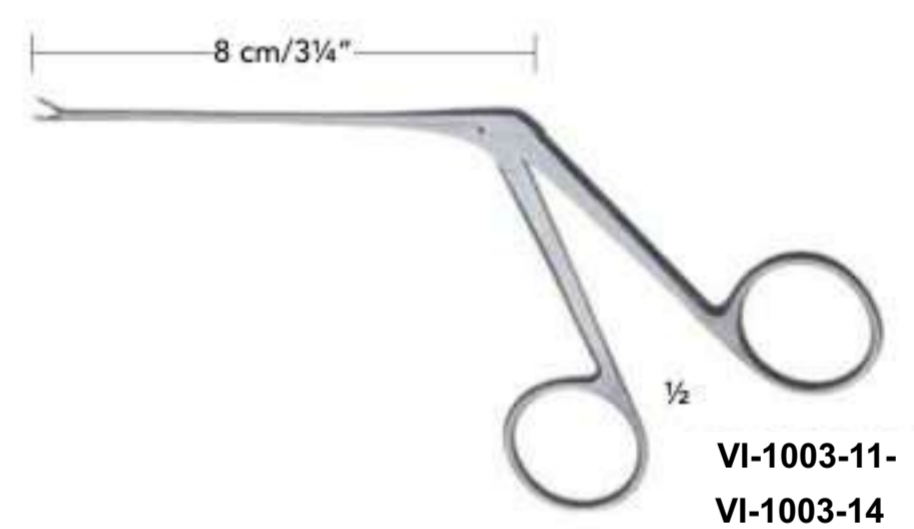
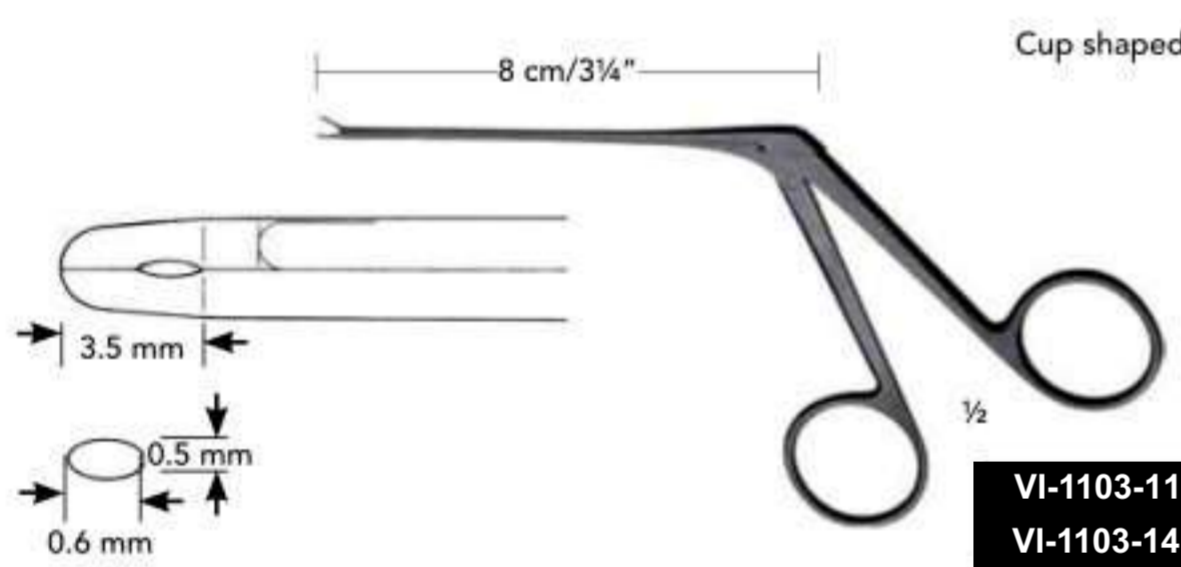
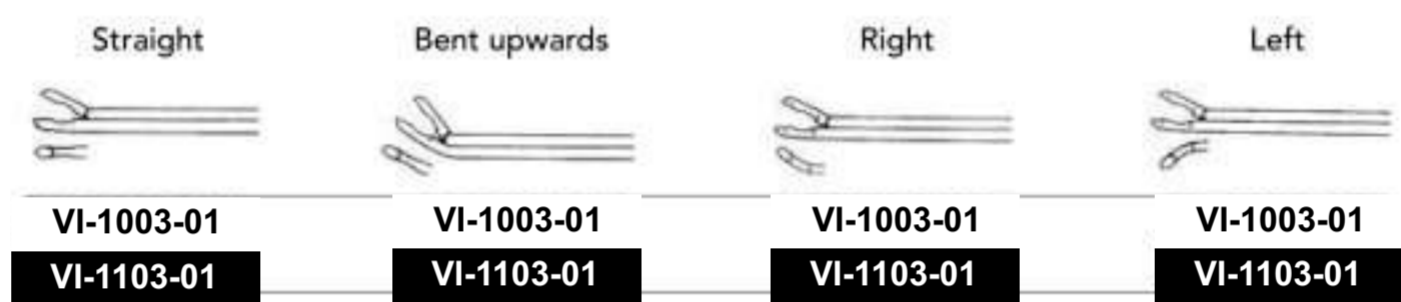
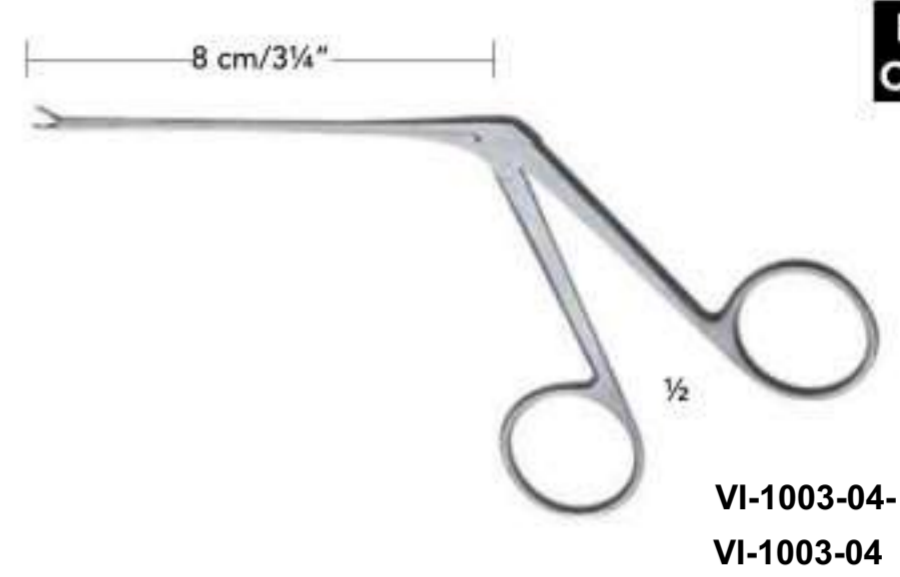
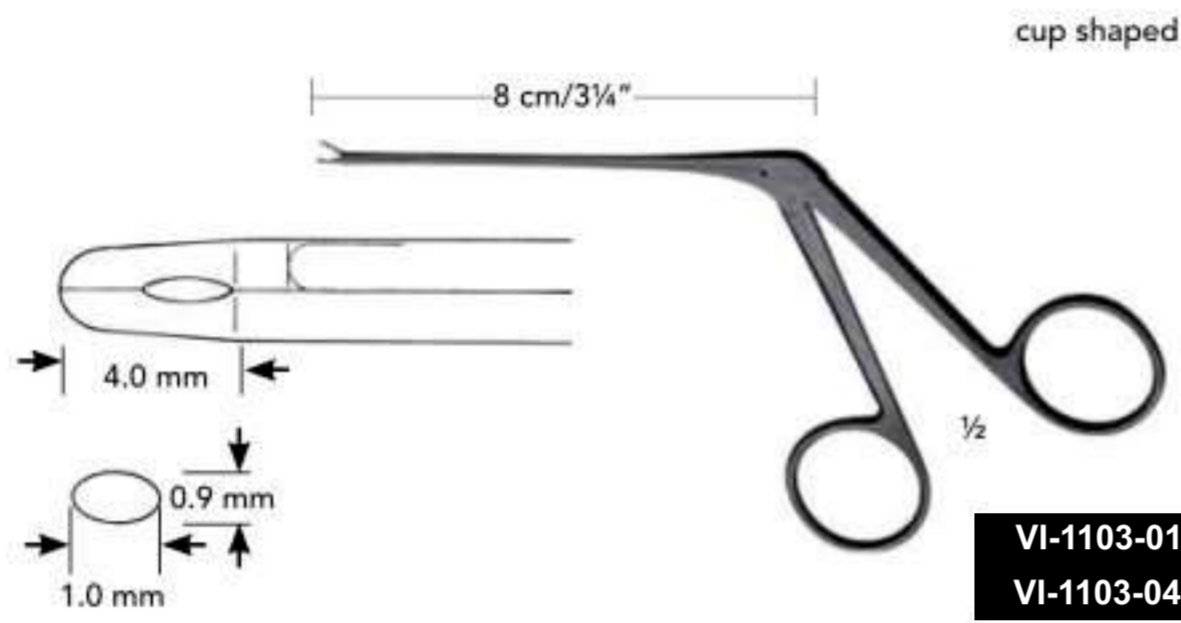



BLACK COATED

Wire bending forceps

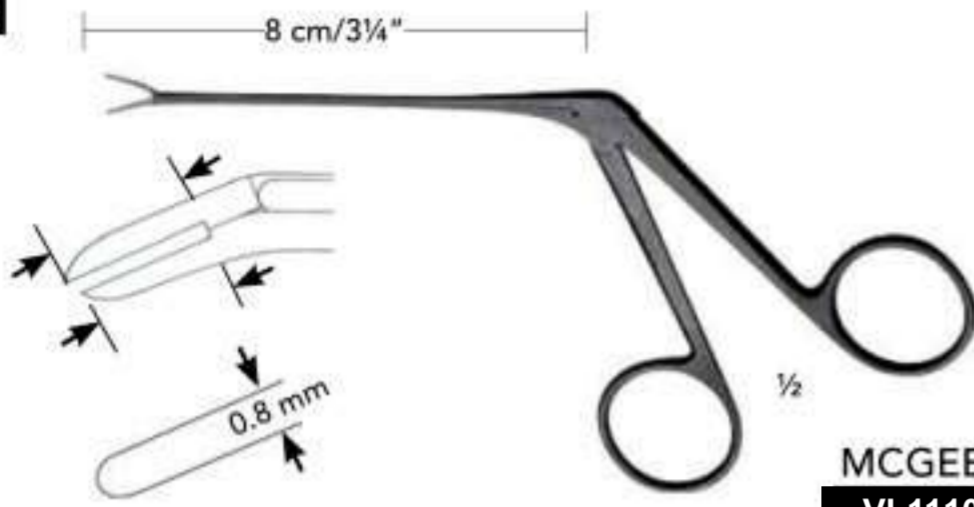

MCGEE
VI-1110-11-
VI-1101-12

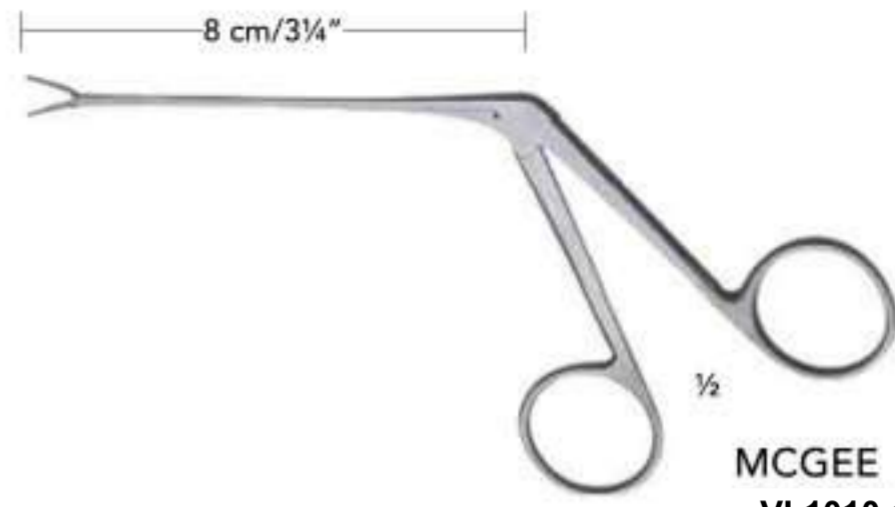

MCGEE
VI-1010-11-
VI-1010-12

Angled downward



0.8 x 3.5 mm
VI-1010-11
VI-1110-11

Angled downward



0.8 x 6.0 mm
VI-1010-12
VI-1110-12

Malleus nipper

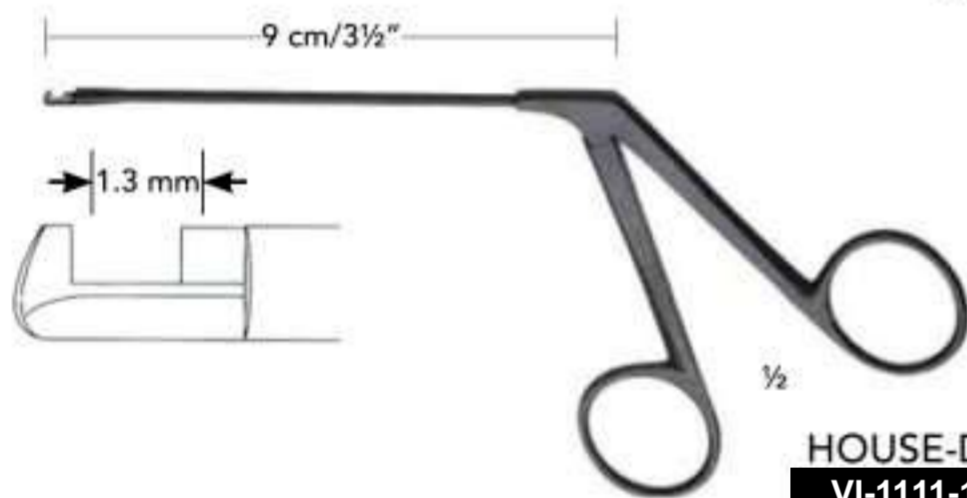

HOUSE-DIETER
VI-1111-11-
VI-1111-07

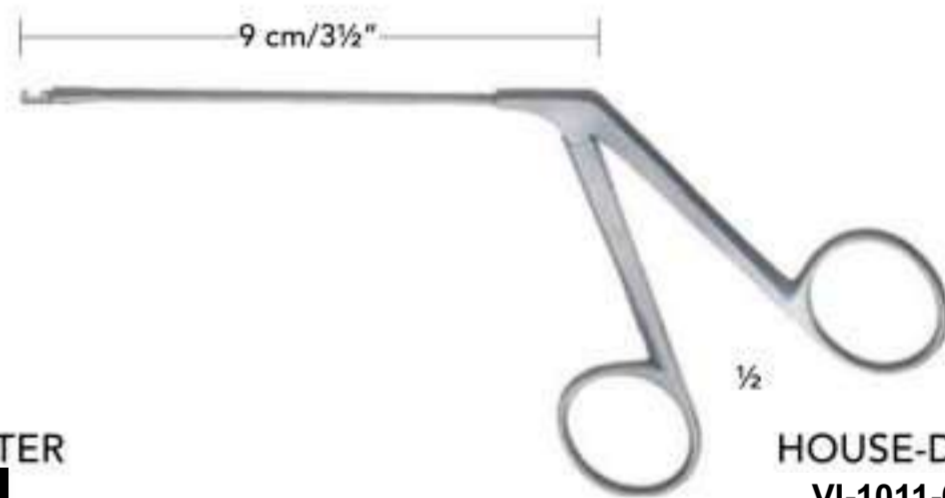

HOUSE-DIETER
VI-1011-01-
VI-1011-07

Up cutting



VI-1011-01
VI-1111-01

Down cutting



VI-1011-02
VI-1111-02

Right cutting



VI-1011-06
VI-1111-06

Left cutting



VI-1011-07
VI-1111-07

Introducing Forceps, for teflon prosthesis

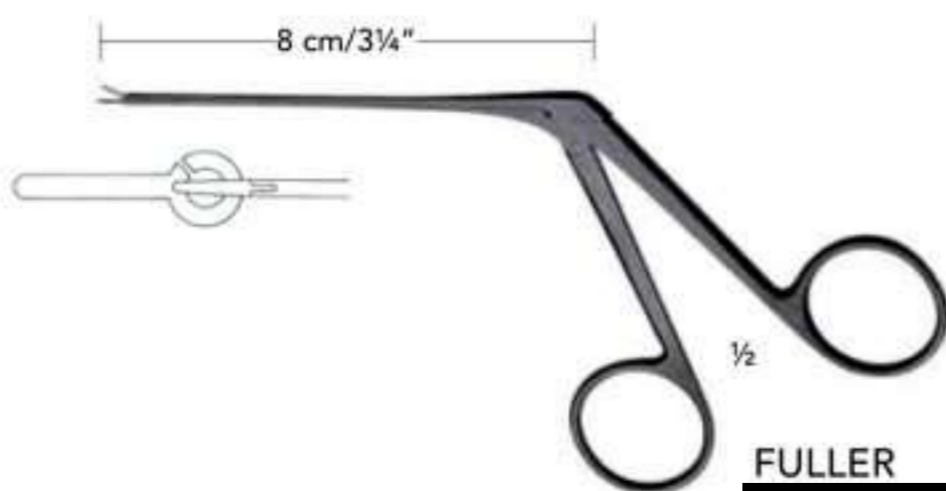

FULLER
VI-1113-01

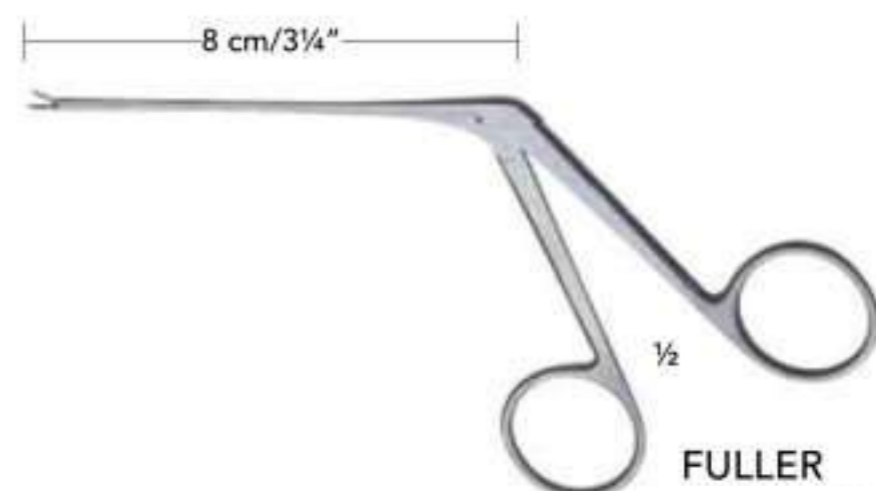

FULLER
VI-1013-01

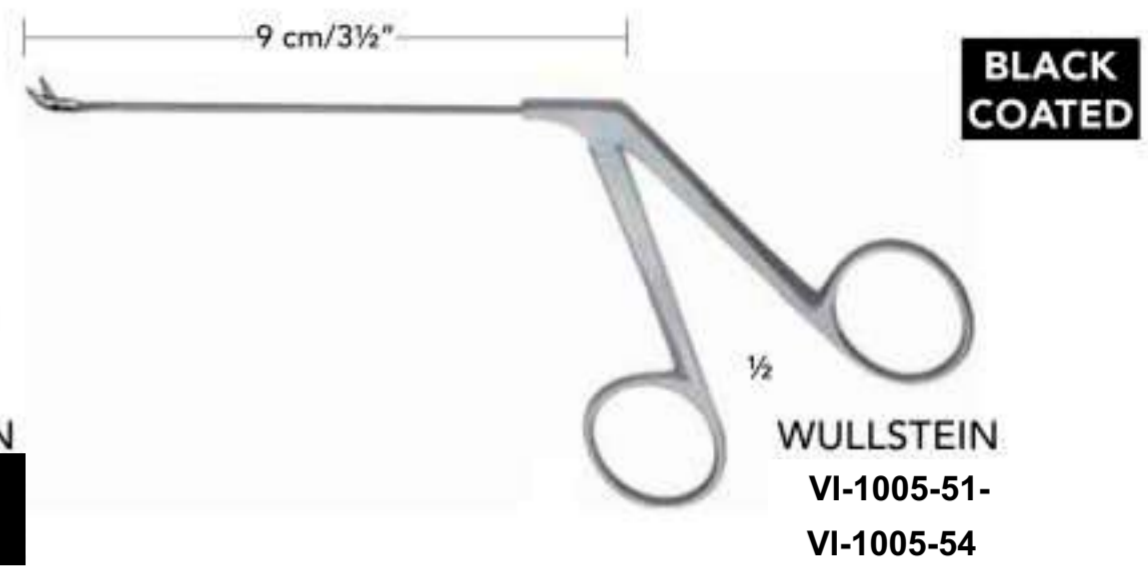
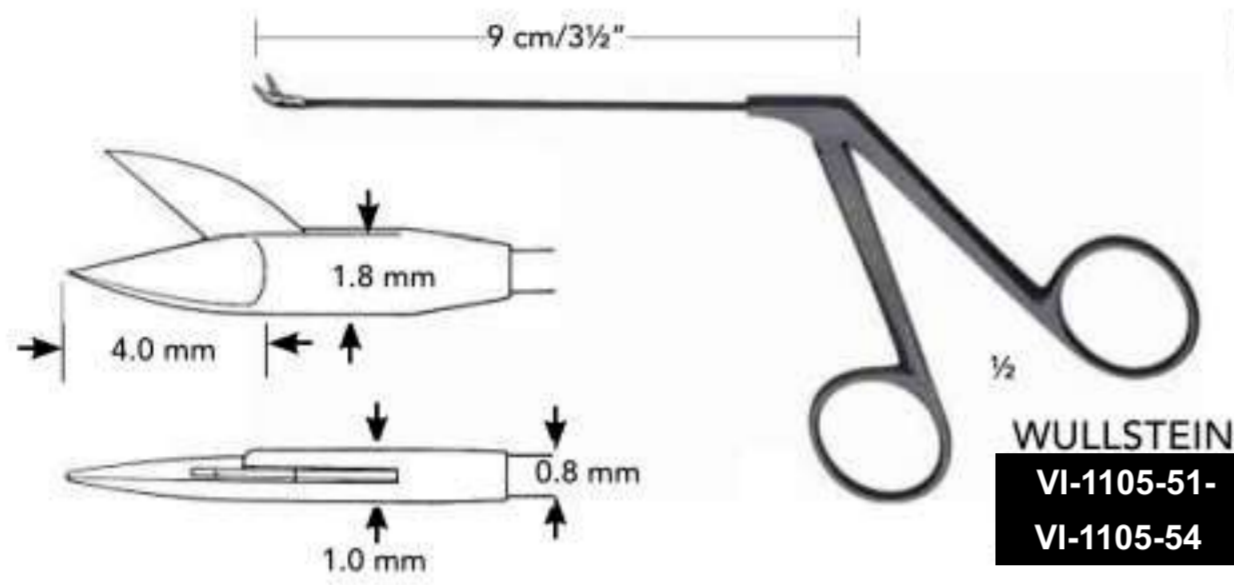

Straight



VI-1005-51
VI-1105-51

Bent upwards



VI-1005-52
VI-1105-52

Right



VI-1005-53
VI-1105-53

Left

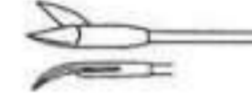

VI-1005-54
VI-1105-54

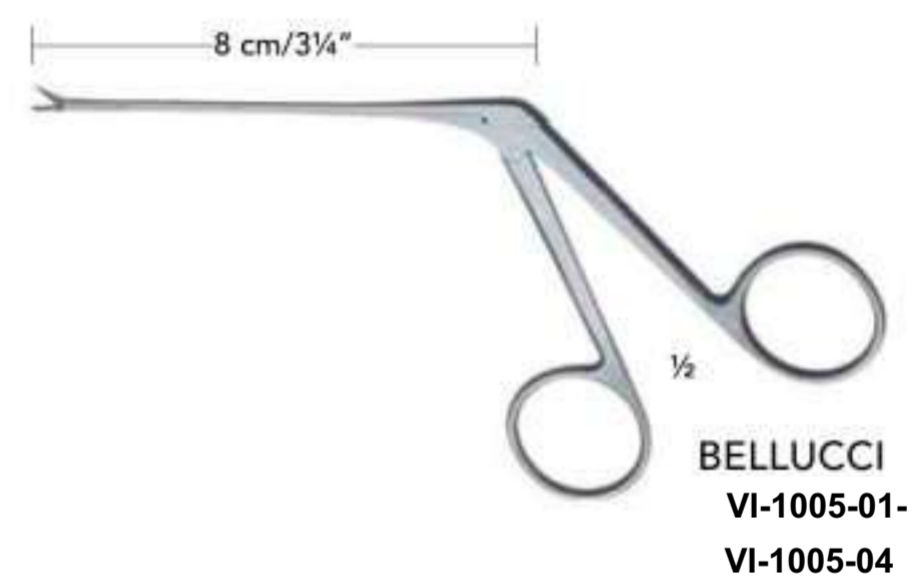
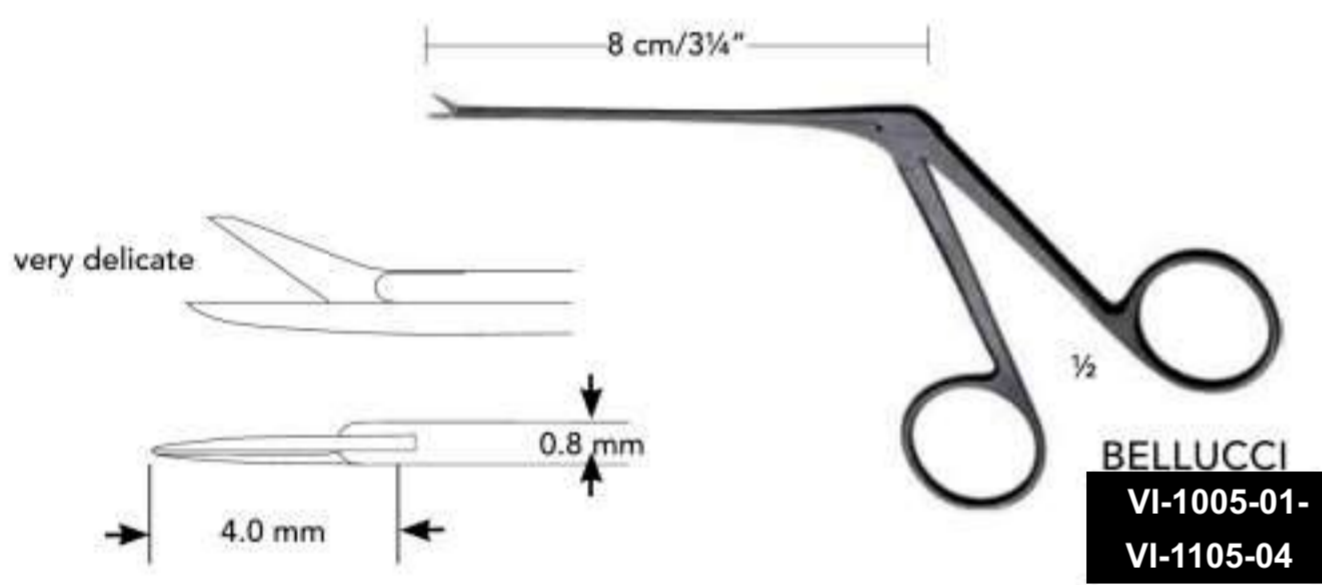

Straight



VI-1005-01
VI-1105-01

Bent upwards



VI-1005-02
VI-1105-02

Right



VI-1005-03
VI-1105-03

Left



VI-1005-04
VI-1105-04

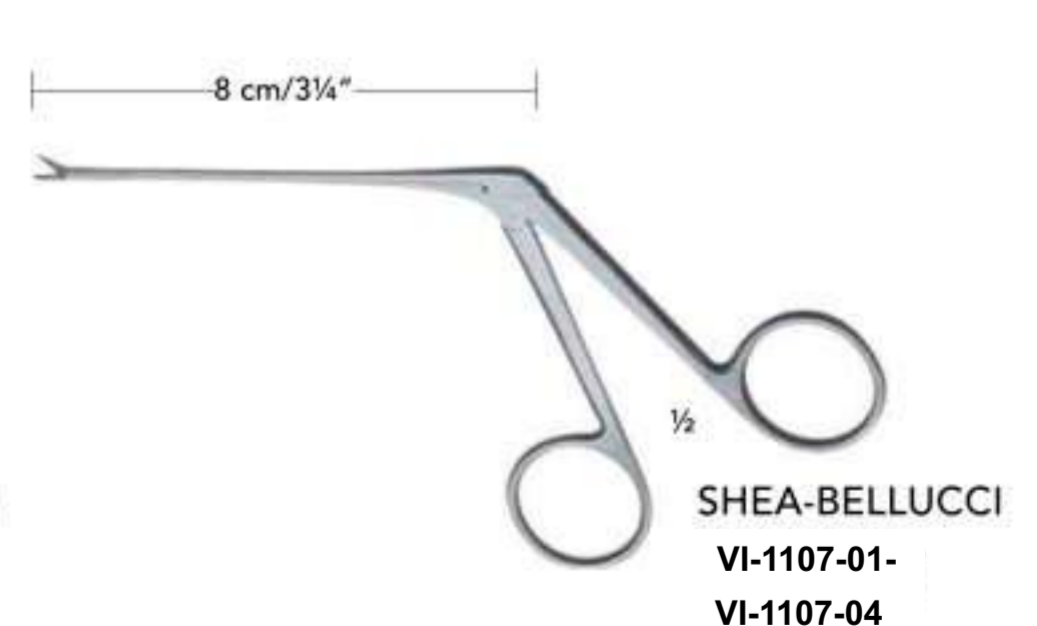
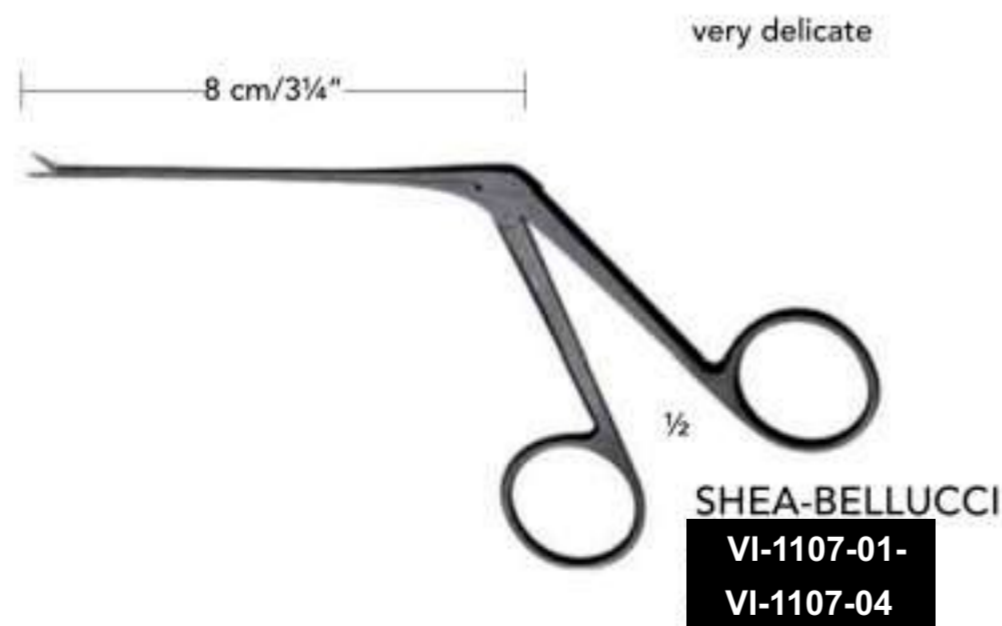

Straight



VI-1007-01
VI-1107-01

Bent upwards



VI-1007-02
VI-1107-02

Right



VI-1007-03
VI-1107-03

Left



VI-1007-04
VI-1107-04



Sickle knife



SCHUKNECHT
VI-1020-06
14.5 cm/5¾"

Roller knives

Vertical



SCHUKNECHT
VI-1020-01
15.5 cm/6"

Horizontal



SCHUKNECHT
VI-1020-02
15.5 cm/6"

Micro knife



ROSEN
15 cm/6"



Diameter

- Ø 1.0 mm
- Ø 1.4 mm
- Ø 1.5 mm
- Ø 1.6 mm
- Ø 2.0 mm
- Ø 2.3 mm
- Ø 2.5 mm
- Ø 2.6 mm
- Ø 2.8 mm
- Ø 3.0 mm

- VI-1021-20
- VI-1021-09
- VI-1021-10

- VI-1022-10
- VI-1022-14
- VI-1022-16
- VI-1022-20
- VI-1022-26
- VI-1022-28
- VI-1022-30

- VI-1023-10
- VI-1023-15
- VI-1023-16
- VI-1023-20
- VI-1023-23
- VI-1023-25
- VI-1023-26
- VI-1023-28
- VI-1023-30

Sickle knife



WULLSTEIN
VI-1020-11
15.5 cm/6"

Mucosa knife



TABB
VI-1020-16
15.5 cm/6"

Flap knife



PLESTER
VI-1020-21
15 cm/6"

Ear knives



SEXTON
VI-1513-17
17 cm/6¾"

Bayonet



SEXTON-GERZOG
VI-1514-17
17 cm/6¾"



Tympanum needles



POLITZER
VI-1630-16
17.5 cm/7"



POLITZER
VI-1616-13
16 cm/6¼"



POLITZER
VI-1655-16
15.5 cm/6"



POLITZER
VI-1657-16
16 cm/6¼"



LUCAE
VI-1661-18
18 cm/7"



LUCAE
VI-1663-18
17.5 cm/7"

Micro ear needles



16 cm/6¼"



BARBARA
VI-1624-01



BARBARA
VI-1624-02



BARBARA
VI-1624-03



ROSEN
VI-1624-04

Micro ear hooks



Hook
25°

- 0.3 mm VI-1024-06
- 0.6 mm VI-1024-07
- 1.0 mm VI-1024-08



Hook
45°

- 0.3 mm VI-1024-11 VI-1024-21
- 0.6 mm VI-1024-12 VI-1024-22
- 1.0 mm VI-1024-13 VI-1024-23
- 1.2 mm VI-1024-14 VI-1024-24
- 1.5 mm VI-1024-15 VI-1024-25
- 2.0 mm VI-1024-16 VI-1024-26
- 2.5 mm VI-1024-17 VI-1024-27



Hook
90°

- 0.5 mm VI-1024-31
- 1.0 mm VI-1024-32

Micro ear needles



VI-1029-01



VI-1029-02

BARBARA
15.5 cm/6"

Micro ear hooks

	bent upwards	angled
	90°	90°
0.3 mm	VI-1025-01	VI-1025-06
0.6 mm	VI-1025-02	VI-1025-07
1.0 mm	VI-1025-03	VI-1025-08

Micro ear hooks

	25°	25°	25°	45°
			SHAMBAUGH	
	VI-1030-06	VI-1030-07	VI-1030-08	VI-1030-11
	Ø 0.3 mm	Ø 0.6 mm	Ø 1.0 mm	Ø 0.3 mm

Micro ear hooks

	bent upwards	angled
	MCGEE	MCGEE
0.5 mm	VI-1027-01	VI-1027-11
1.0 mm	VI-1027-02	VI-1027-12

for footplate

	45°	45°	Exploring hook blunt	Blunt	Attic dissector
			45°		90°
	VI-1030-12	SHAMBAUGH	SHEA		AUSTIN
	Ø 0.6 mm	VI-1030-13	VI-1030-20		VI-1030-30
		Ø 1.0 mm	Ø 2.0 mm		Ø 3.0 mm

15.5 cm/6¼"

15 cm/6"

Ear hooks

VI-1598-01	VI-1585-01 Fig. 1	VI-1585-02 Fig. 2	VI-1585-03 Fig. 3	VI-1585-04 Fig. 4	VI-1577-01 Fig. 1	VI-1577-02 Fig. 2
VI-1598-02	VI-1585-05 Fig. 5	VI-1585-06 Fig. 6	VI-1585-07 Fig. 7	VI-1577-03 Fig. 3		

Ear hooklets

VI-1577-01 Fig. 1	VI-1577-02 Fig. 2
VI-1577-03 Fig. 3	

Ear hooklet

VI-1570-16

DAY
17 cm/6¾"

WAGENER
14 cm/5½"

LUCAE
14 cm/5½"

HARTMANN
16 cm/6¼"



Micro hooks, Picks

	Straight	25° Angled
0.3 mm	VI-1026-03	VI-1027-03
0.5 mm	VI-1026-05	VI-1027-05
0.6 mm	VI-1026-06	VI-1027-06
1.0 mm	VI-1026-10	VI-1027-10



SHAMBAUGH
16 cm/6¼"

Micro otology hooks

	25° Upwards	25° Downwards
0.3 mm	VI-1040-11	VI-1041-16
0.6 mm	VI-1040-12	VI-1041-17
1.0 mm	VI-1040-13	VI-1041-18



15.5 cm/6¼"

	45° Angled	90° Angled
0.3 mm	VI-1032-03	40-1034-03
0.5 mm	VI-1032-05	40-1034-05
0.6 mm	VI-1032-06	40-1034-06
1.0 mm	VI-1032-10	40-1034-10
1.2 mm	VI-1032-12	40-1034-12
1.5 mm	VI-1032-15	40-1034-15
2.0 mm	VI-1032-20	40-1034-20
2.5 mm	VI-1032-25	40-1034-25

	45° Upwards	45° Downwards
0.3 mm	VI-1042-21	VI-1043-26
0.6 mm	VI-1042-22	VI-1043-27
1.0 mm	VI-1042-23	VI-1043-28

	90° Upwards	90° Downwards
0.3 mm	VI-1045-03	VI-1046-03
0.6 mm	VI-1045-06	VI-1046-06
1.0 mm	VI-1045-10	VI-1046-10

Micro dissectors

	angled to right	angled to left
VI-1036-01	15 cm/6"	VI-1036-02
VI-1036-05	15.5 cm/6¼"	VI-1036-06
FISCH		HOUSE
		15.5 cm/6¼"

Micro measuring rods

VI-1038-01	Ø 3.5 mm
VI-1038-02	Ø 4.0 mm
VI-1038-03	Ø 4.5 mm
VI-1038-04	Ø 5.0 mm

Foreign body levers

MOLDENHAUER	VI-1561-16
	16 cm/6¼"
ZAUFAL	VI-1563-16
	15 cm/6"



Periosteal elevators



LEMPERT
VI-1737-20
20.5 cm/8"



LEMPERT
VI-1739-17
18 cm/7"



LEMPERT
21.5 cm/8 1/2"

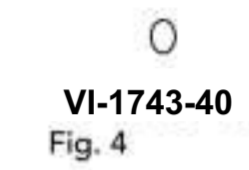
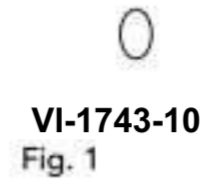

Foreign body instrument

Micro ear periosteal elevator



ROSEN
VI-1036-23
15 cm/6"



WEBER-LOCH
VI-1551-01
17 cm/6"



SHAPLEIGH
15 cm/6"



Micro curettes

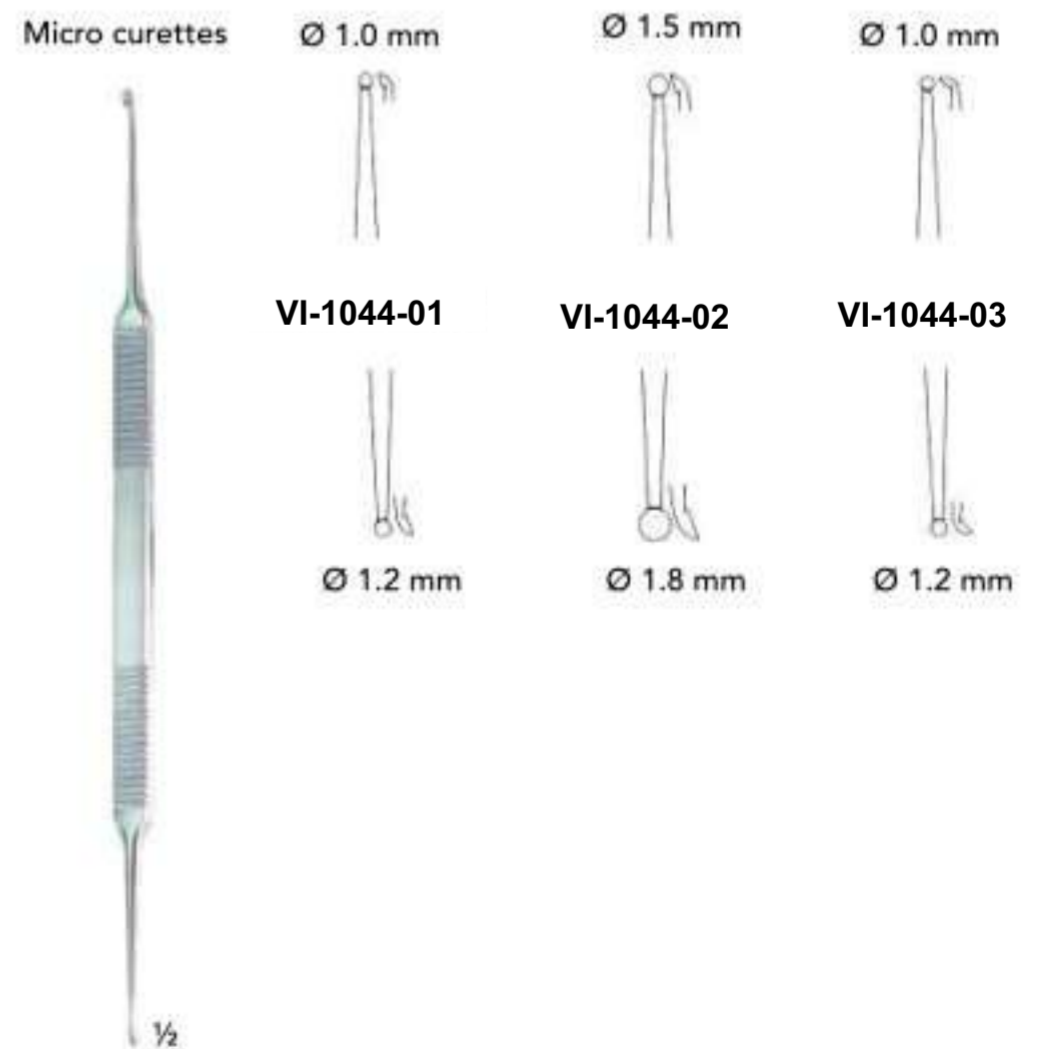

HOUSE
14.5 cm/5 3/4"



Ear curettes		sharp						
		VI-1494-01	VI-1494-02	VI-1494-10	VI-1494-11	VI-1494-12	VI-1494-13	VI-1494-14
		1.8 mm Fig. 000	2.1 mm Fig. 00	2.6 mm Fig. 0	3.2 mm Fig. 1	3.7 mm Fig. 2	4.1 mm Fig. 3	4.4 mm Fig. 4
		blunt						
		VI-1495-01	VI-1495-02	VI-1495-10	VI-1495-11	VI-1495-12	VI-1495-13	VI-1495-14
		1.8 mm Fig. 000	2.1 mm Fig. 00	2.6 mm Fig. 0	3.2 mm Fig. 1	3.7 mm Fig. 2	4.1 mm Fig. 3	4.4 mm Fig. 4
		sharp						
		VI-1496-01	VI-1496-02	VI-1496-10	VI-1496-11	VI-1496-12	VI-1496-13	VI-1496-14
		1.8 mm Fig. 000	2.1 mm Fig. 00	2.6 mm Fig. 0	3.2 mm Fig. 1	3.7 mm Fig. 2	4.1 mm Fig. 3	4.4 mm Fig. 4
		blunt						
		VI-1497-01	VI-1497-02	VI-1497-10	VI-1497-11	VI-1497-12	VI-1497-13	VI-1497-14
		1.8 mm Fig. 000	2.1 mm Fig. 00	2.6 mm Fig. 0	3.2 mm Fig. 1	3.7 mm Fig. 2	4.1 mm Fig. 3	4.4 mm Fig. 4

Ear Scoops		Ear scoop sharp		Ear loops	
LANGENBECK VI-1491-13 13 cm/5"		JANSEN VI-1532-15 16 cm/6 1/4"	BARTH VI-1534-18 18 cm/7"	VI-1554-01 Fig. 1	
				VI-1554-02 Fig. 2	
				VI-1554-03 Fig. 3	
					GROSS VI-1543-12 16 cm/5"
					BILLEAU 16.5 cm/6 1/2"

○
VI-1112-10
Ø 3 mm
Fig. 0

○
VI-1112-11
Ø 4 mm
Fig. 1

○
VI-1112-12
Ø 5 mm
Fig. 2

○
VI-1112-13
Ø 6 mm
Fig. 3

○
VI-1112-14
Ø 7.5 mm
Fig. 4

○
VI-1113-30
Ø 3 mm
Fig. 1

○
VI-1113-45
Ø 4.5 mm
Fig. 3

○
VI-1113-55
Ø 5.5 mm
Fig. 5

○
VI-1113-65
Ø 6.5 mm
Fig. 7

○
VI-1113-75
Ø 7.5 mm
Fig. 9

○
VI-1113-40
Ø 4 mm
Fig. 2

○
VI-1113-50
Ø 5.0 mm
Fig. 4

○
VI-1113-60
Ø 6.0 mm
Fig. 6

○
VI-1113-70
Ø 7.0 mm
Fig. 8



HARTMANN
3.6 cm/1 1/2"

Fig.

Set of 3	0-3	VI-1112-03
Set of 3	2-4	VI-1114-03
Set of 4	1-4	VI-1115-04



HARTMANN

Fig.

Set of 3	1, 2, 4	KI-1113-03
Set of 4	3, 5, 7, 9	KI-1113-04
Set of 4	2, 4, 6, 8	KI-1114-04

○
VI-1115-05
4.5 x 5 mm

○
VI-1115-06
5.5 x 6 mm

○
VI-1115-07
6.5 x 7 mm

○
VI-1115-08
7.5 x 8 mm

Chrome plated, Oval



HARTMANN

○
VI-1118-11
Ø 4 mm
Fig. 1

○
VI-1118-12
Ø 5 mm
Fig. 2

○
VI-1118-13
Ø 6 mm
Fig. 3

○
VI-1118-14
Ø 7.5 mm
Fig. 4



TOYNBEE
3.6 cm/1 1/2"

Fig

Set for 3	2 - 4	VI-1118-03
Set for 4	1 - 4	VI-1119-04



VI-1120-82
Ø 8.2 mm

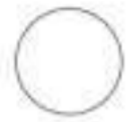

VI-1120-77
Ø 7.7 mm

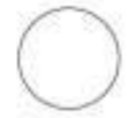

VI-1120-72
Ø 7.2 mm

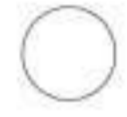

VI-1120-67
Ø 6.7 mm

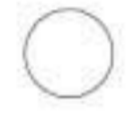

VI-1120-63
Ø 6.3 mm

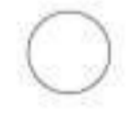

VI-1120-58
Ø 5.8 mm



VI-1120-53
Ø 5.3 mm



VI-1120-48
Ø 4.8 mm



VI-1120-43
Ø 4.3 mm



VI-1120-38
Ø 3.8 mm



VI-1120-33
Ø 3.3 mm

Satin finish, round



FARRIOR

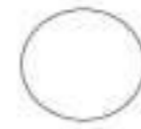

VI-1121-80
9.0 mm

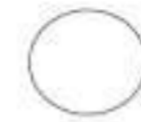

VI-1121-75
8.5 mm

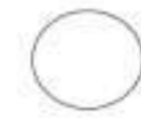

VI-1121-70
8.0 mm

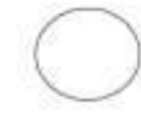

VI-1121-65
7.5 mm

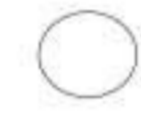

VI-1121-60
7.0 mm

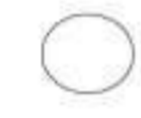

VI-1121-55
6.5 mm



VI-1121-50
6.0 mm



VI-1121-45
5.5 mm



VI-1121-40
5.0 mm



VI-1121-35
4.5 mm



VI-1121-33
4.0 mm

Satin finish, oval



FARRIOR

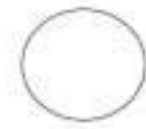

VI-1122-80
9.0 mm

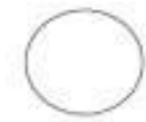

VI-1122-75
8.5 mm



VI-1122-70
8.0 mm

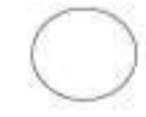

VI-1122-65
7.5 mm



VI-1122-60
7.0 mm

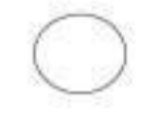

VI-1122-55
6.5 mm



VI-1122-50
6.0 mm



VI-1122-45
5.5 mm



VI-1122-40
5.0 mm



VI-1122-35
4.5 mm



VI-1122-33
4.0 mm

Satin finish, oval



FARRIOR

VI-1148-12
Ear specula storage rack

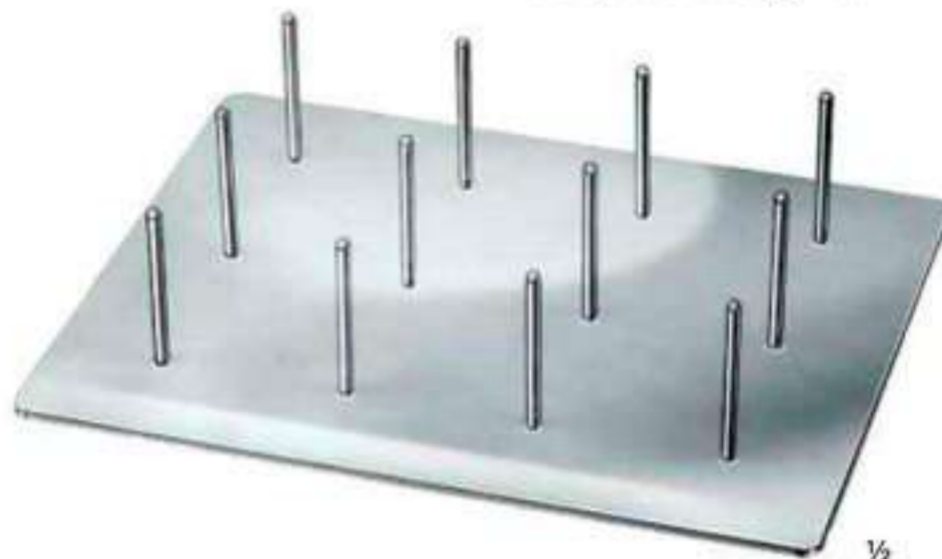

VI-1134-07
Ø 11.5 mm
Fig. 7



VI-1134-06
Ø 11.5 mm
Fig. 6



VI-1134-05
Ø 10.5 mm
Fig. 5



VI-1134-04
Ø 8.5 mm
Fig. 4



VI-1134-03
Ø 7.5 mm
Fig. 3



VI-1134-02
Ø 6.5 mm
Fig. 2



VI-1134-01
Ø 5.5 mm
Fig. 1



VI-1132-06
11.5 mm
Fig. 6



VI-1132-05
10.5 mm
Fig. 5

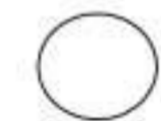

VI-1132-04
9.5 mm
Fig. 4



VI-1132-03
8.5 mm
Fig. 3



VI-1132-02
7.5 mm
Fig. 2



VI-1132-01
6.5 mm
Fig. 1

VI-1132-00
Fig. 1-6
Complete set





FRENCH
VI-1170-07
C² 16



FRENCH
VI-1172-08
C¹ 32



HARTMANN
VI-1172-09
C 64



HARTMANN
VI-1174-10
C 128



HARTMANN
VI-1177-11
C¹ 256



with dampers

ALUMINIUM

VI-1180-10
C 128



VI-1182-11
C 256



VI-1184-12
C 512



VI-1186-13
C 1024



VI-1188-14
C 2048

VI-1190-00

Set of 5
(C 128 Hz - C 2048 Hz)



HARTMANN
VI-1189-10
C 128



HARTMANN
VI-1192-11
C¹ 256



HARTMANN
VI-1194-12
C² 512



HARTMANN
VI-1196-13
C³ 1024



HARTMANN
VI-1198-14
C⁴ 2048



HARTMANN
VI-1200-15
C⁵ 4096



LUCAE
VI-1210-10
C 128



LUCAE
VI-1212-11
C¹ 256



LUCAE
VI-1214-12
C² 512

VI-1216-98
Socket only



LUCAE
VI-1216-13
C³ 1024



LUCAE
VI-1218-14
C⁴ 2048



LUCAE
VI-1220-15
C⁵ 4096



LUCAE
VI-1221-10
C 128

VI-1221-98
Socket only



with hammer, pinwheel, brush & wheel for Neuro

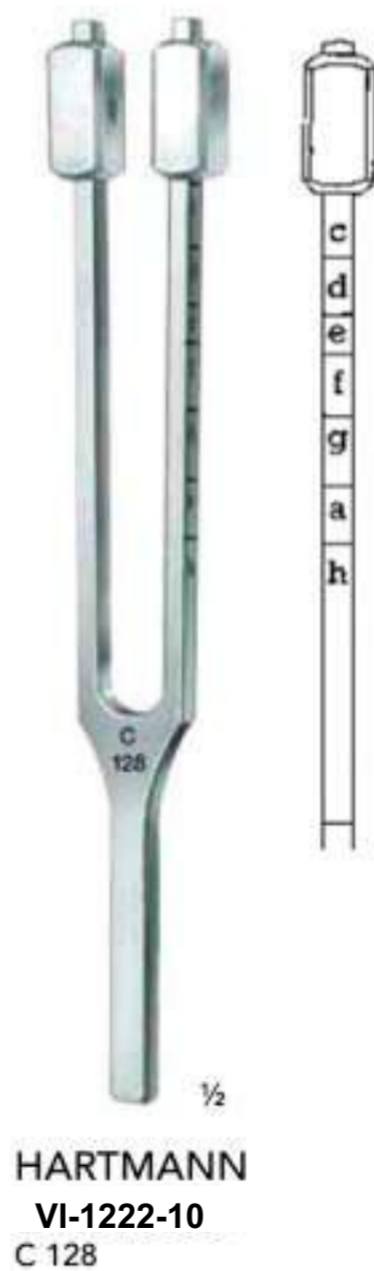

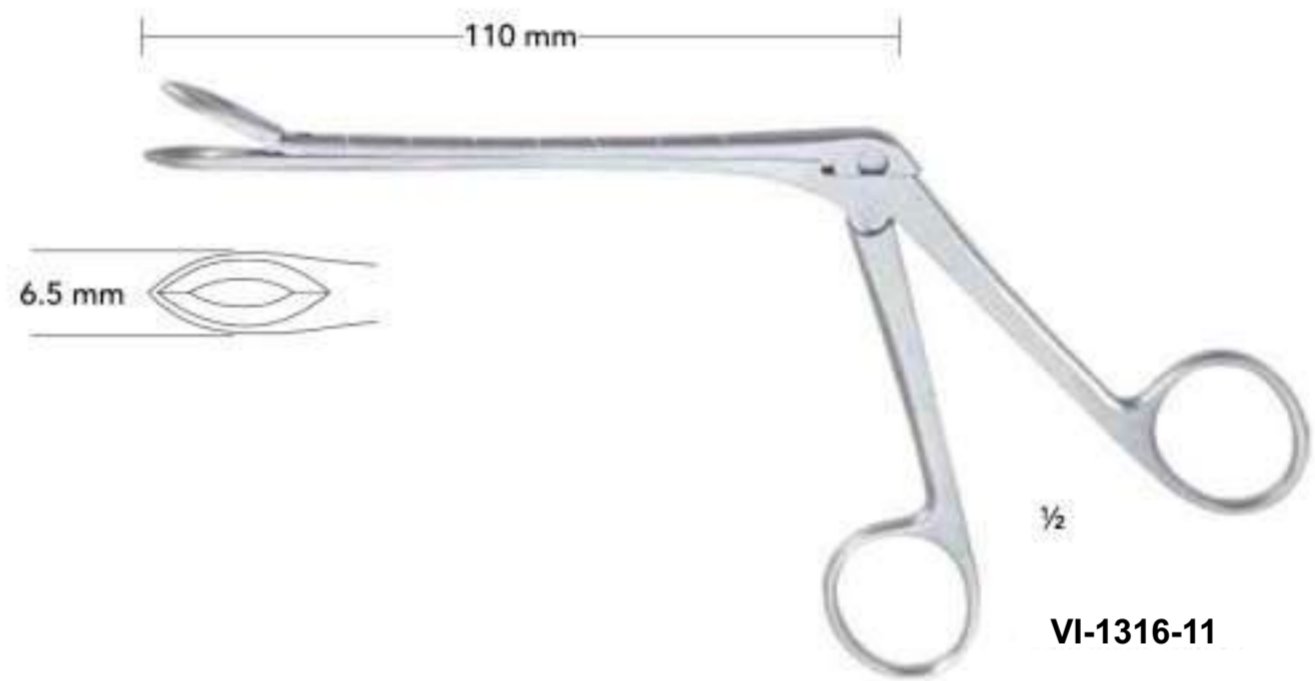
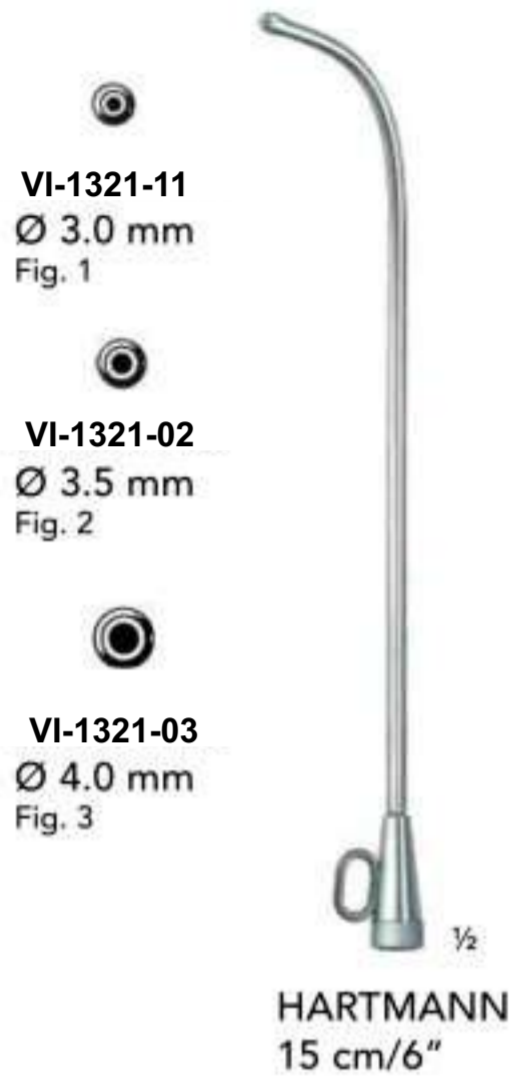



TROELTSCH (WILDE)
VI-1371-11
10.5 cm/4"



TROELTSCH (WILDE)
VI-1375-12
11 cm/4 1/4"



TROELTSCH (WILDE)
VI-1381-13
12.5 cm/4 3/4"



LUCAE
VI-1391-14
14.5 cm/5 3/4"



JANSEN
16.0 cm/6 1/4" VI-1395-16
21.5 cm/8 1/2" VI-1395-20

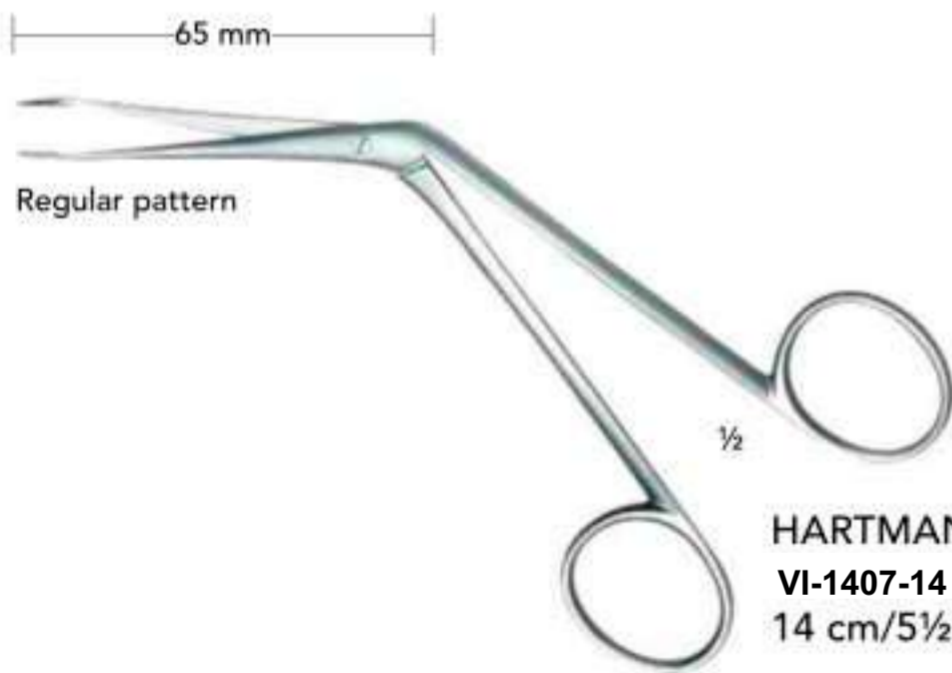

HARTMANN
VI-1407-14
14 cm/5 1/2"

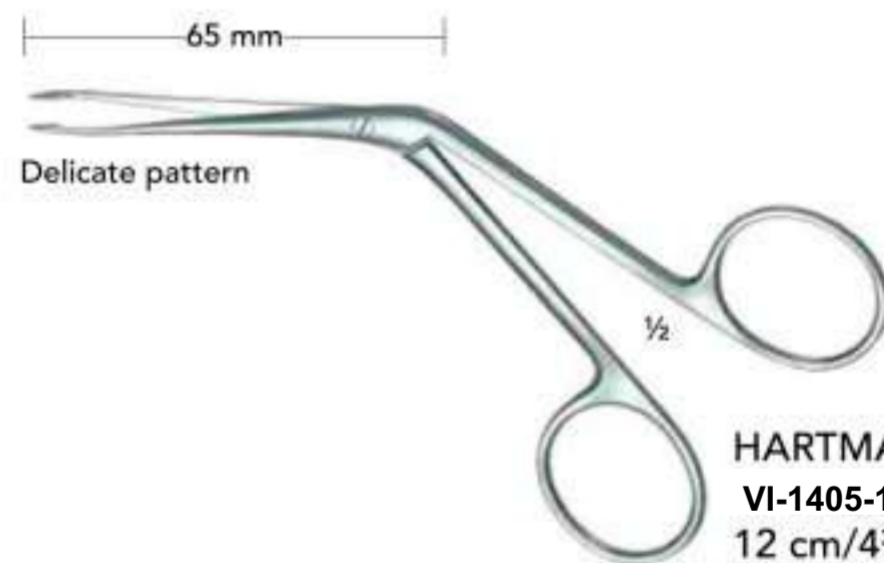

HARTMANN
VI-1405-12
12 cm/4 3/4"



QUIRE
VI-1418-10
10.5 cm/4 1/4"



BUCK
VI-1416-11
11.5 cm/4 1/2"



Serrated



HARTMANN-WULLSTEIN
1.8 x 4.0 mm **VI-1425-04**
1.8 x 8.0 mm **VI-1425-08**

Smooth



HARTMANN-WULLSTEIN
1.8 x 8.0 mm **VI-1426-04**



HARTMANN-WULLSTEIN
8.5 cm/3 1/2"
Ø 1.0 mm **VI-1442-10**
Ø 2.0 mm **VI-1442-20**
Ø 2.5 mm **VI-1442-25**
Ø 3.0 mm **VI-1442-30**

Serrated



HARTMANN
8.5 cm/3 1/4" **VI-1430-08**
14 cm/5 1/2" **VI-1430-14**
16.5 cm/6 1/2" **VI-1430-16**

1:2



HARTMANN
8.5 cm/3 1/2" **VI-1431-08**
14 cm/5 1/2" **VI-1431-14**

Ø 3 mm



HARTMANN
VI-1445-08
8.5 cm/3 1/4"

Ø 2 mm



HARTMANN-HERZFELD
VI-1442-81
8.5 cm/3 1/4"

Ø 2.5 mm



HARTMANN-HERZFELD
VI-1442-82
8.5 cm/3 1/4"

Ø 3 mm



HARTMANN-HERZFELD
VI-1442-83
8.5 cm/3 1/4"

through cutting
Ø 2 mm



HARTMANN-HOFFMANN
VI-1456-08
8.5 cm/3 1/4"



HARTMANN-NOYES
Serrated **VI-1434-09**
1x2 teeth **VI-1435-09**



STRÜMPEL
VI-1448-08
8.5 cm/3 1/4"

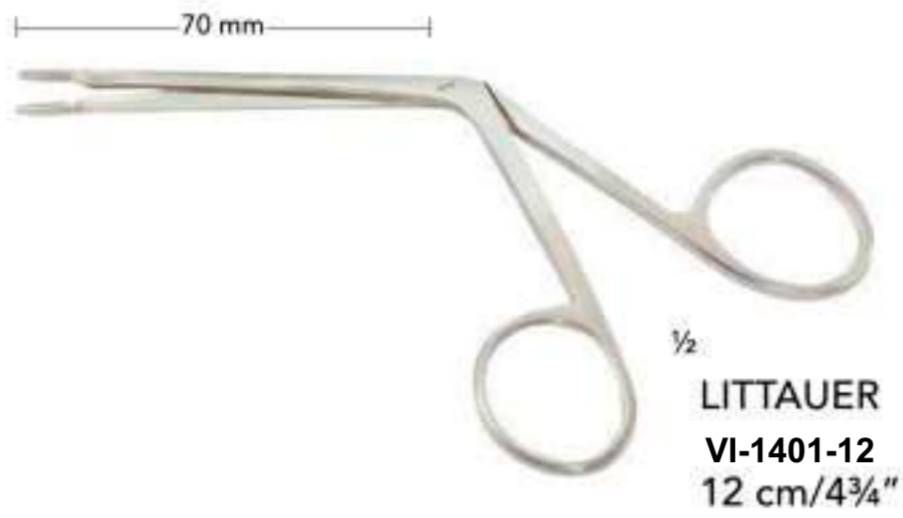

Mastoid Rongeurs

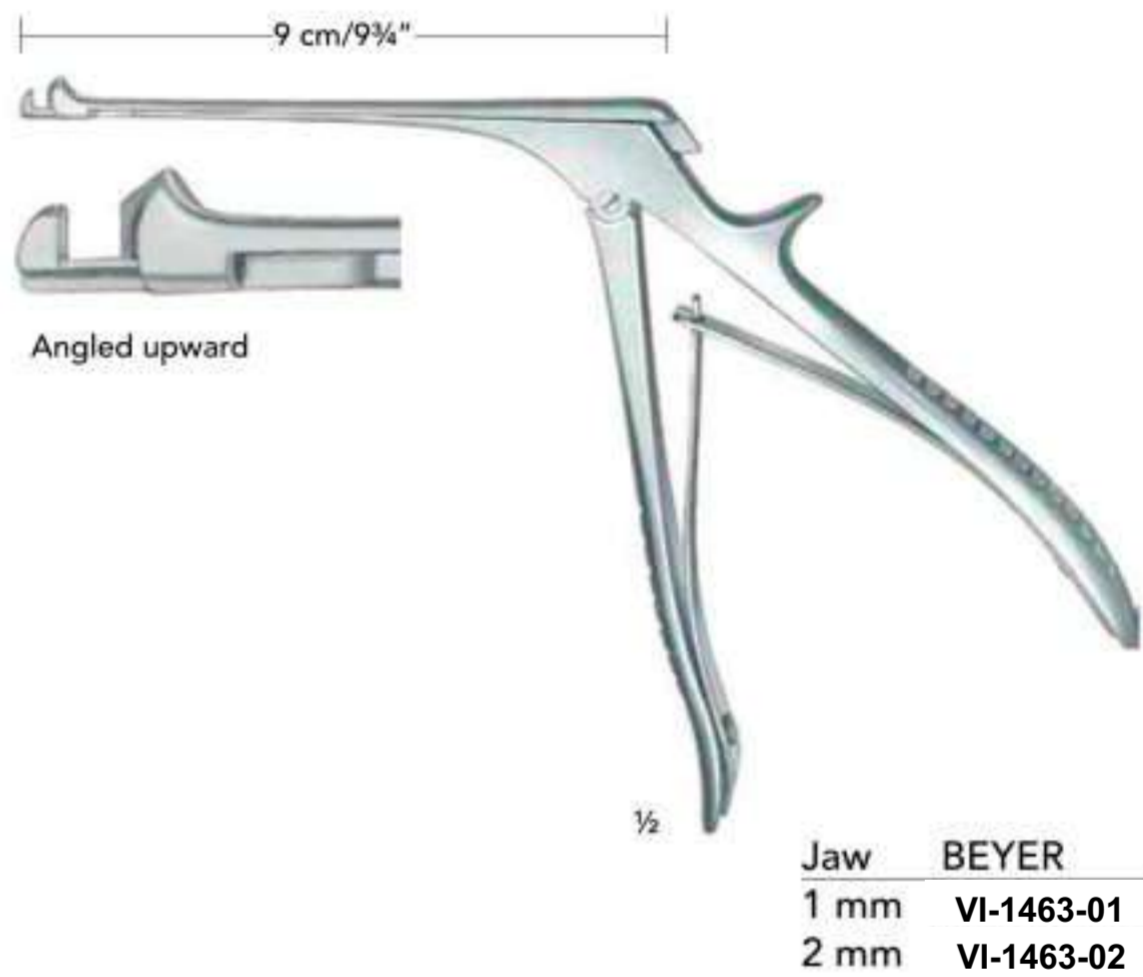

Valve Attachment



VI-1794-02

Suction Nozzle



VI-1794-04

Protecting Disc



VI-1794-05

Metal Olive



VI-1794-06

Conical tip



VI-1794-07

Button ended tip



VI-1794-08

Threaded tip



VI-1794-09



VI-1794-03
Flexible tube



VI-1794-00

Complete, self filling
in plastic pouch

VI-1794-90

Rubber gasket

VI-1794-91

Retention spring

VI-1795-01

Syringe, only
10 ml

VI-1795-90

Complete ear syringe with shield & 2 tips

Irrigation adapters



All metal syringe only Luer-Lock



Accessories for SCHIMMELBUSCH



SCHIMMELBUSCH	
50 ml	VI-1795-50
75 ml	VI-1795-75
100 ml	VI-1795-10
150 ml	VI-1795-15
200 ml	VI-1795-20

SCHIMMELBUSCH	
50 ml	VI-1796-50
75 ml	VI-1796-75
100 ml	VI-1796-10
150 ml	VI-1796-15
200 ml	VI-1796-20



Rhinology

- Adenoid Currettes
- Cartilage Crushers
- Chisels
- Elevators
- Osteotomes
- Gouges
- Nasal Cutting Forceps
- Nasal Dressing Forceps
- Nasal Knives
- Nasal Rasps
- Nasal Retractors
- Nasal Speculas
- Polypus Forceps
- Retractors
- Septum Forceps
- Skin Hooks

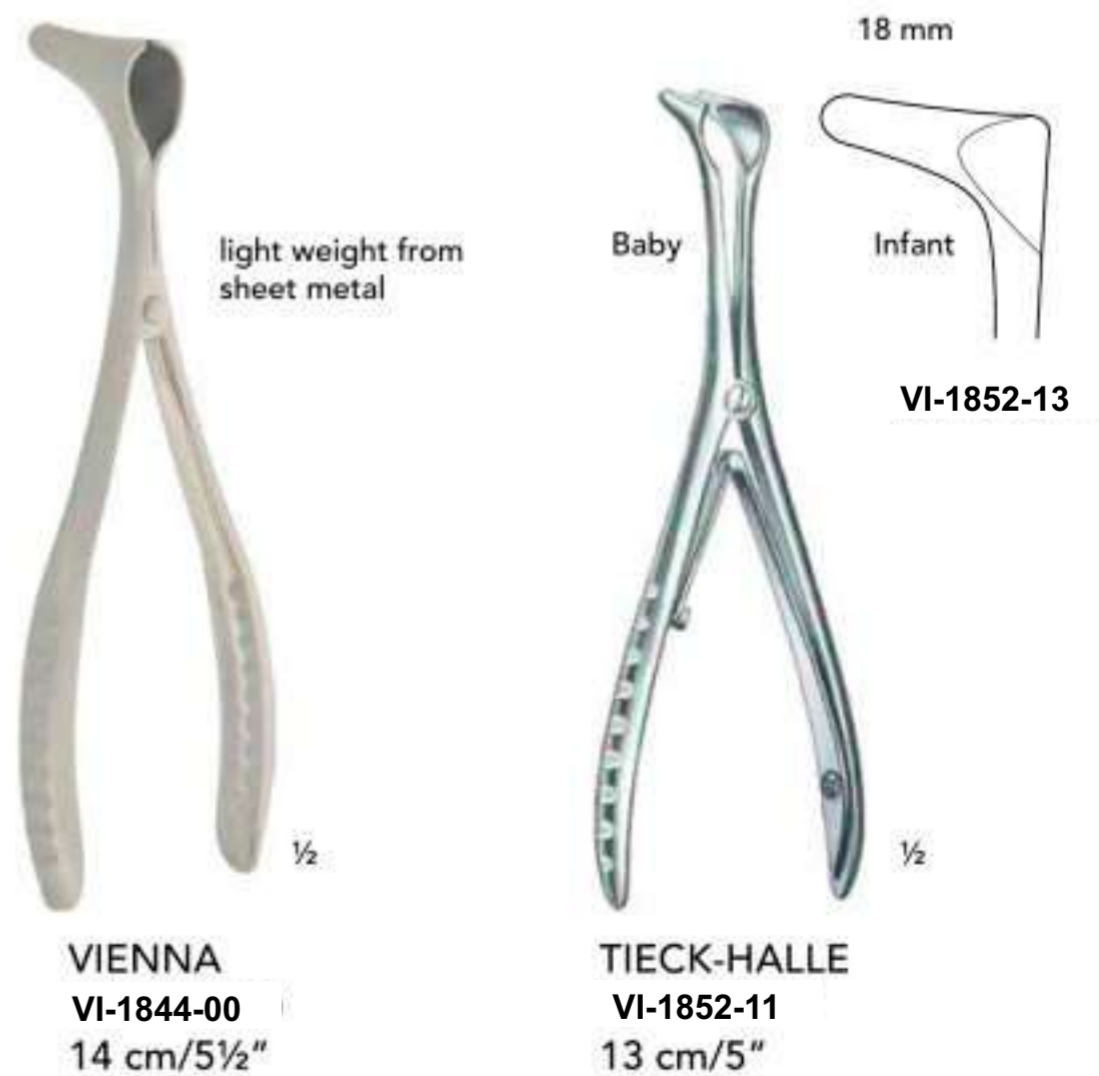
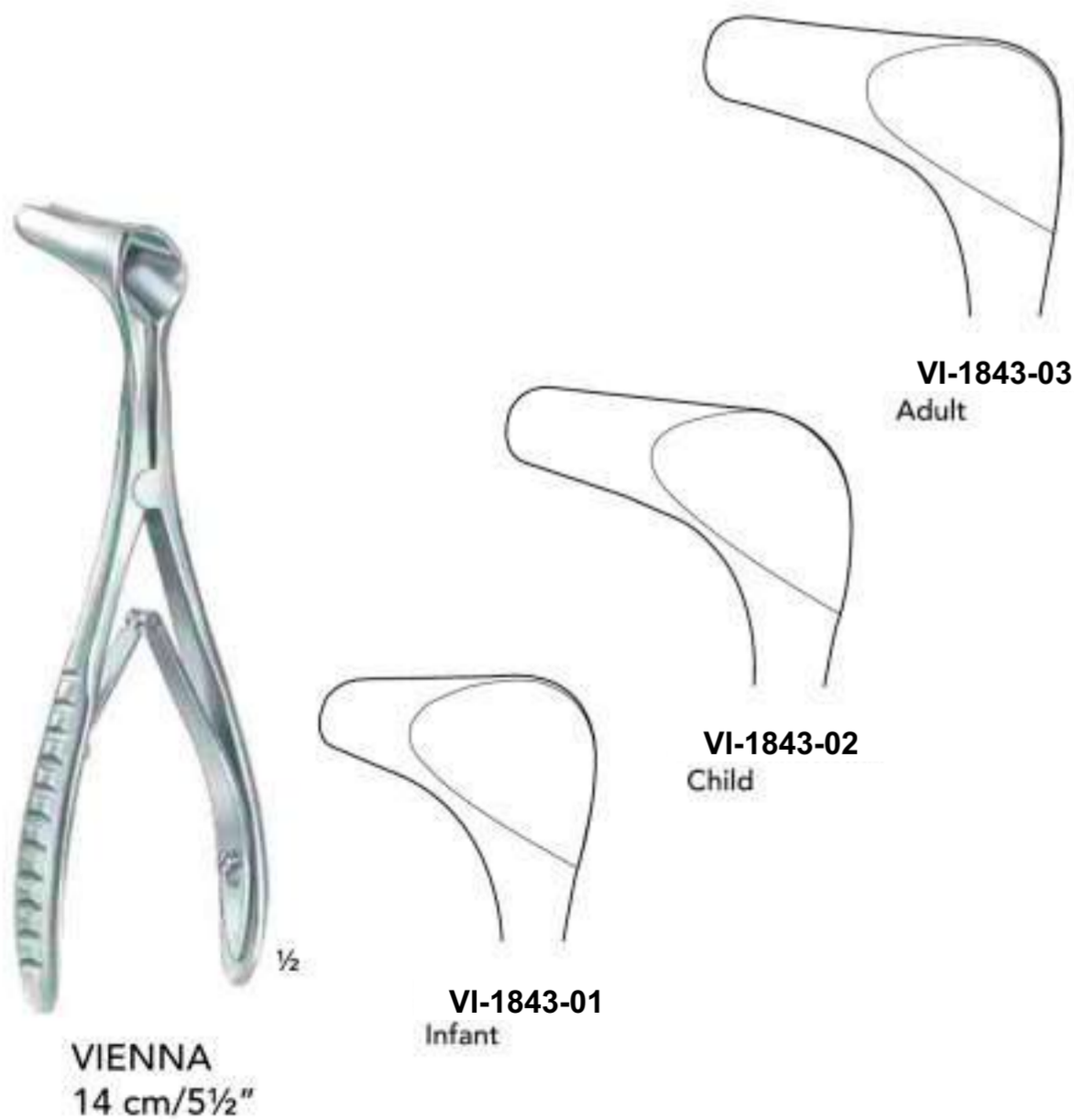
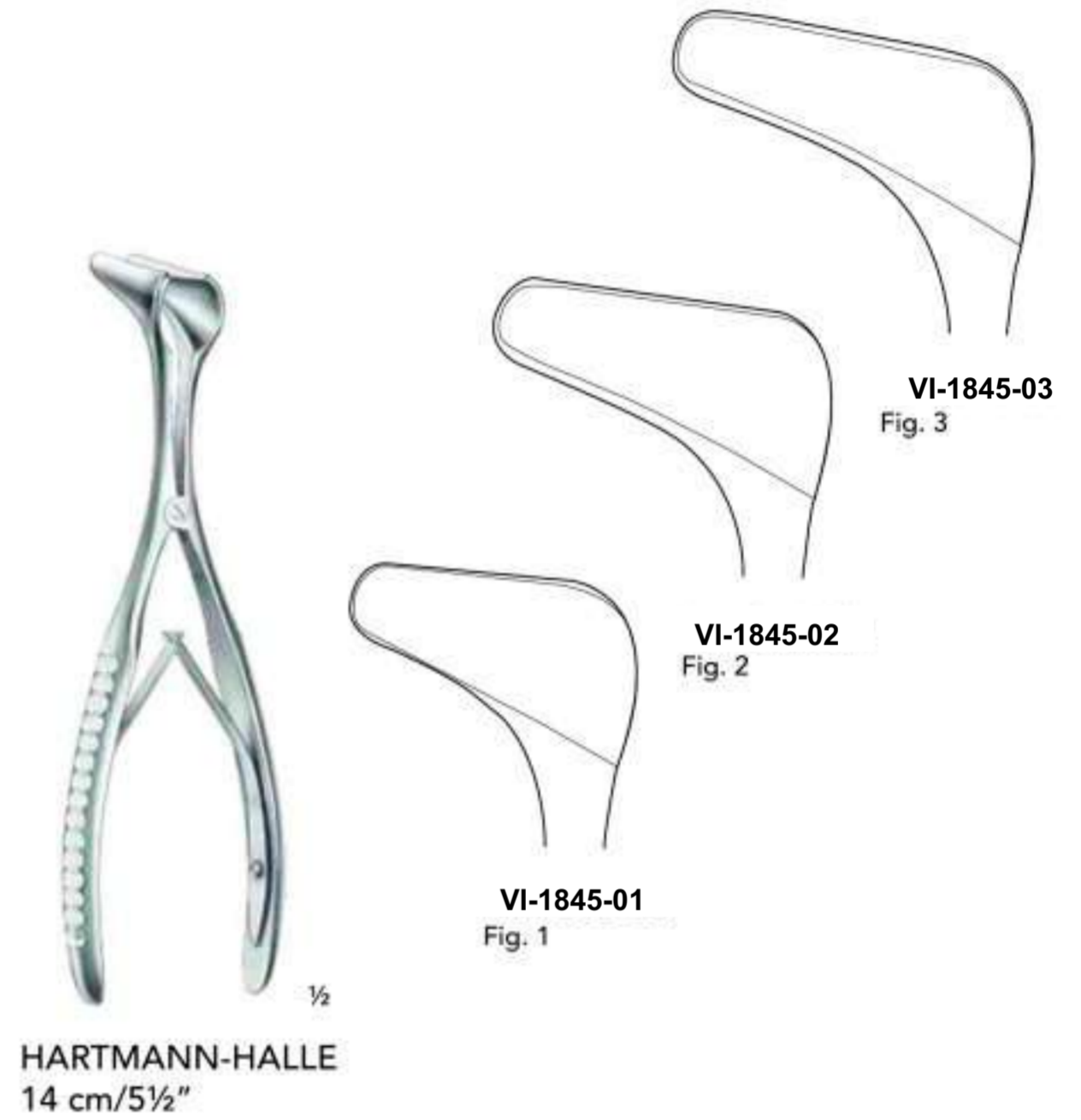
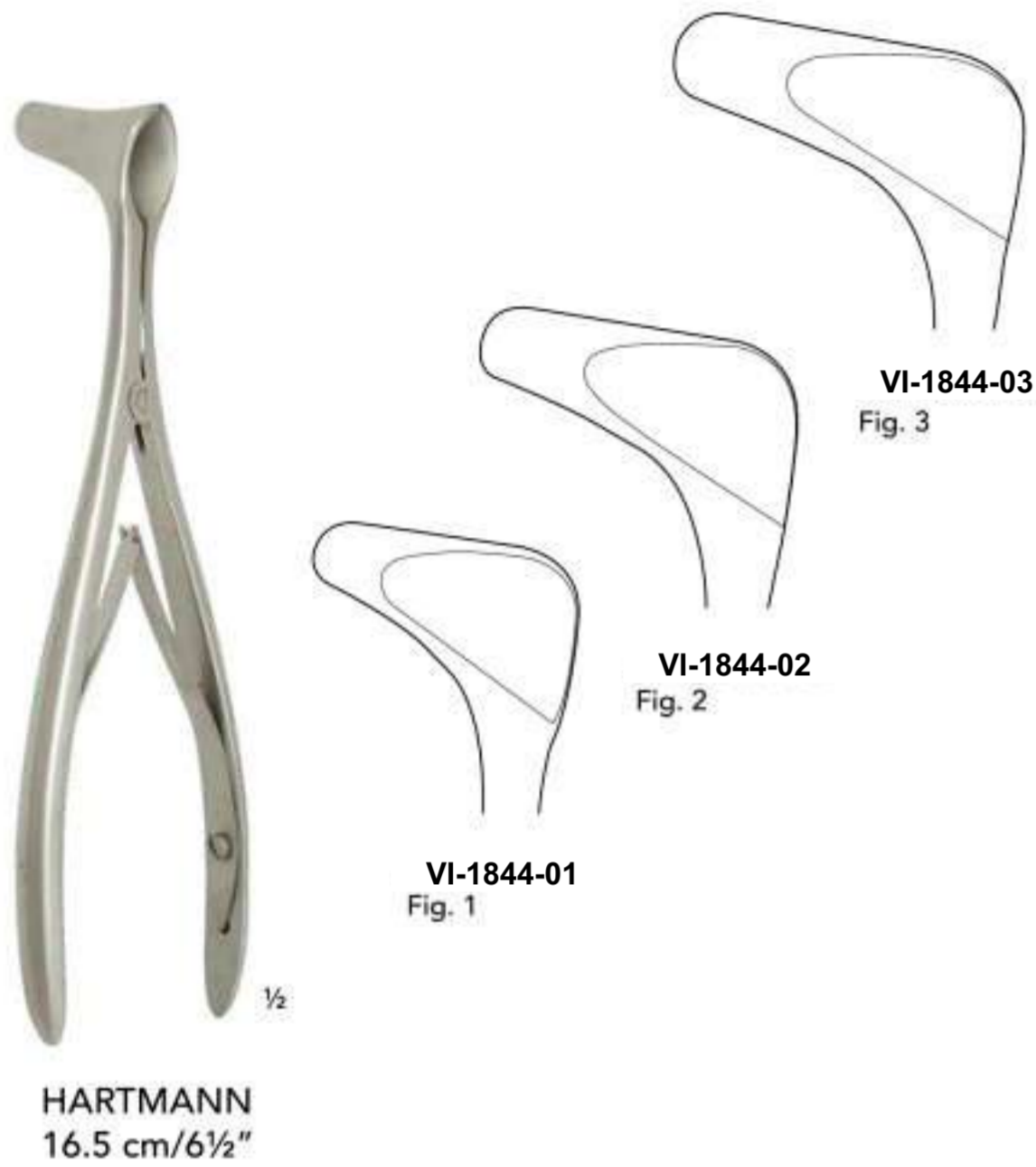



KILLIAN
14 cm/5½"

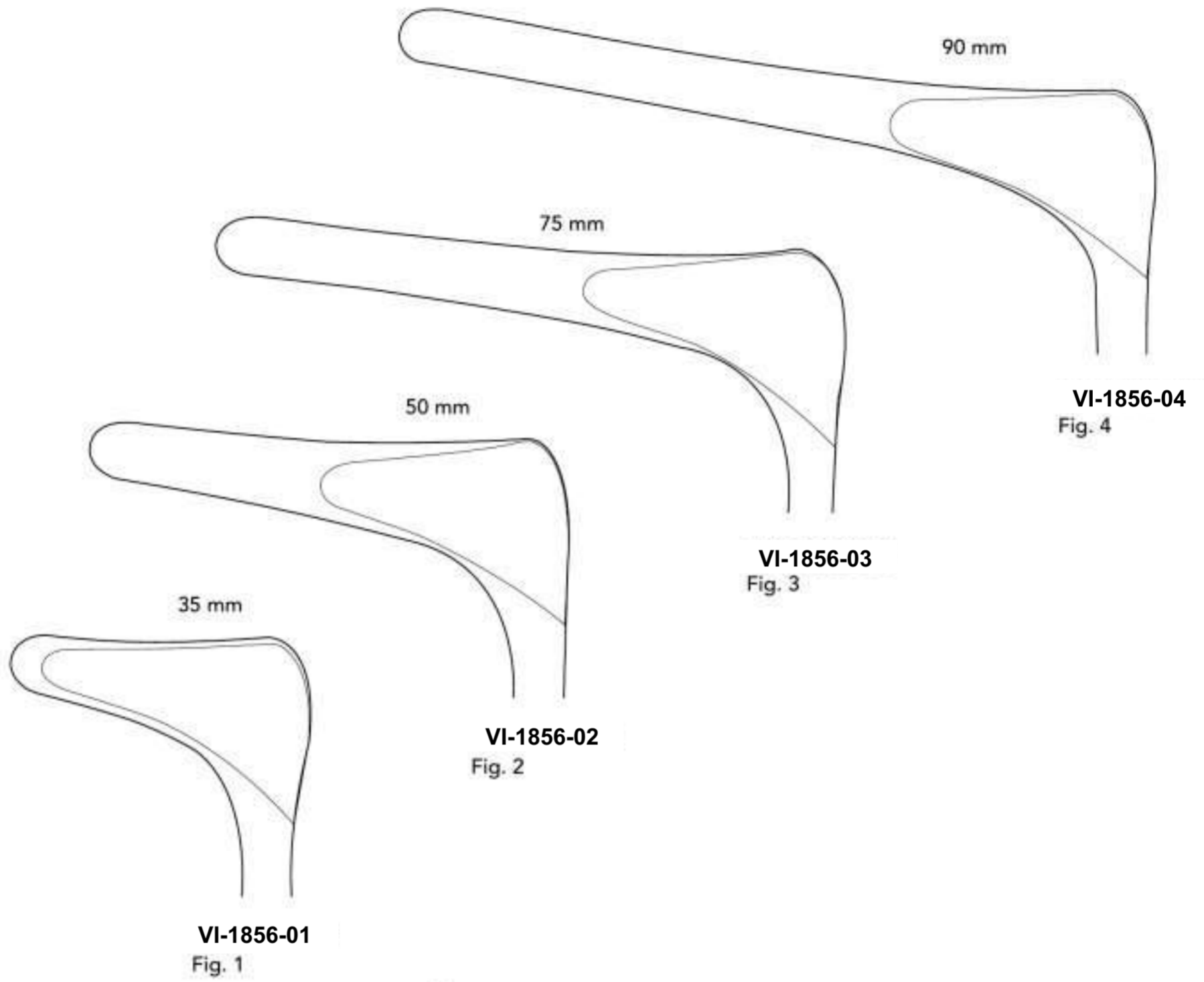

VI-1856-01
Fig. 1

VI-1856-02
Fig. 2

VI-1856-03
Fig. 3

VI-1856-04
Fig. 4



COTTLE
15 cm/6"

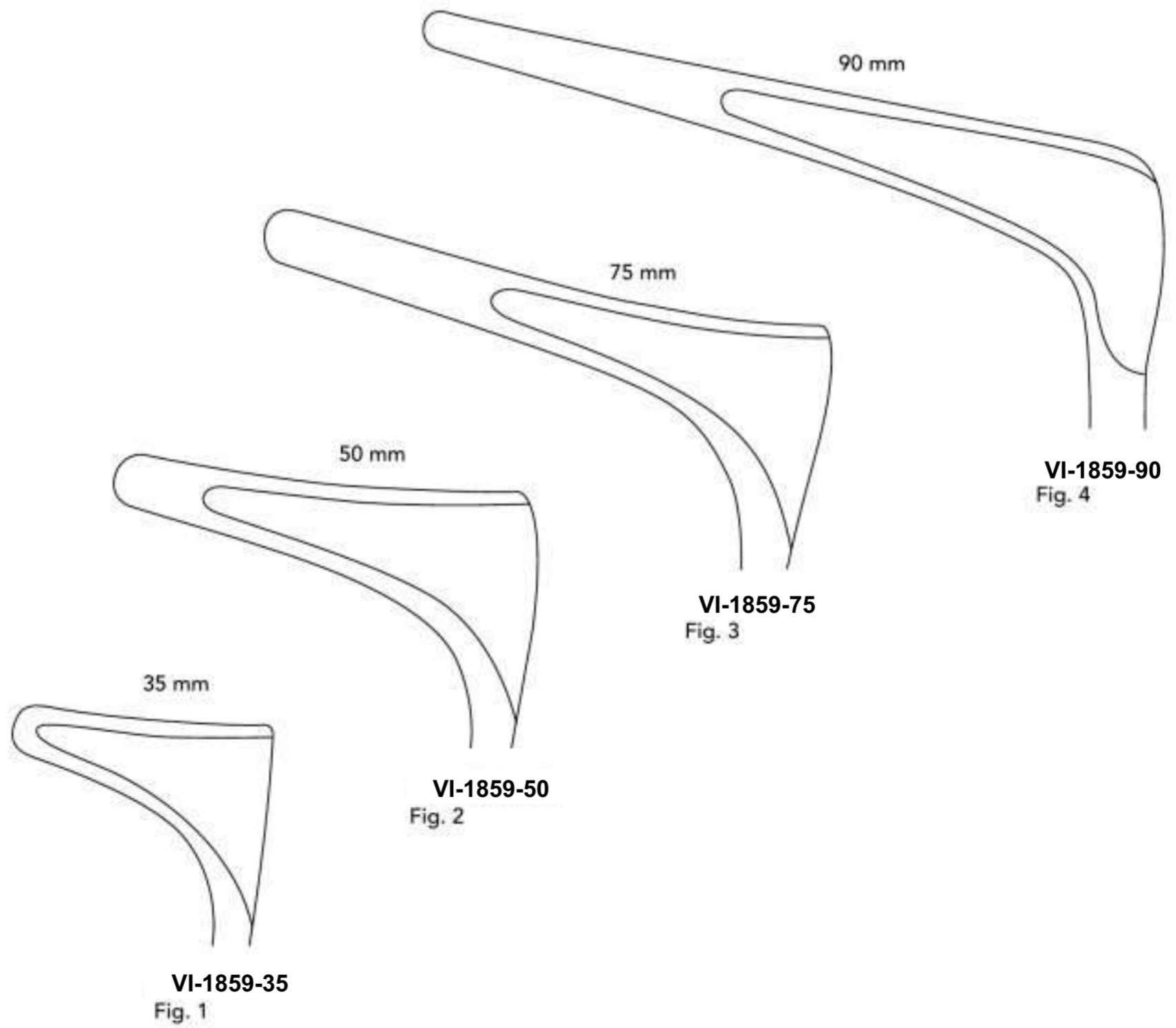

VI-1859-35
Fig. 1

VI-1859-50
Fig. 2

VI-1859-75
Fig. 3

VI-1859-90
Fig. 4



GOLDSMITH-THUDICHUM
6.5 cm/2½"

18.5 x 9.5 mm

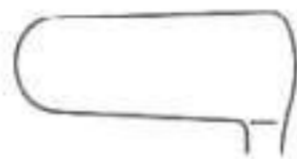

VI-1817-01
Fig. 1

21.0 x 10.5 mm

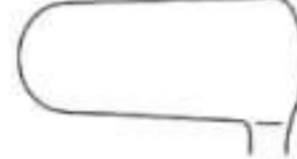

VI-1817-02
Fig. 2

21.0 x 11.5 mm



VI-1817-03
Fig. 3



THUDICHUM (MARK HOVELL)

8.5 x 6.0 mm



VI-1818-70
70 mm

9.0 x 7.0 mm



VI-1818-71
71 mm

12.5 x 8.0 mm



VI-1818-72
72 mm

15.0 x 8.5 mm



VI-1818-73
73 mm

16.5 x 9.0 mm



VI-1818-74
74 mm

18.0 x 10.0 mm

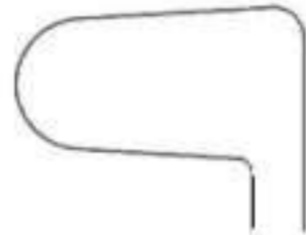

VI-1819-74
74 mm

19.5 x 10.6 mm

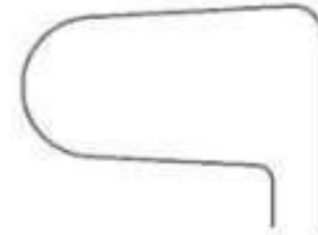

VI-1818-75
75 mm



GRUENWALD (JANSEN)



TROELTSCH
VI-1101-14
14.5 cm/5¾"



TROELTSCH
VI-1101-15
15.5 cm/6"



TROELTSCH
15 cm/6" VI-1105-15
18 cm/7" VI-1105-18

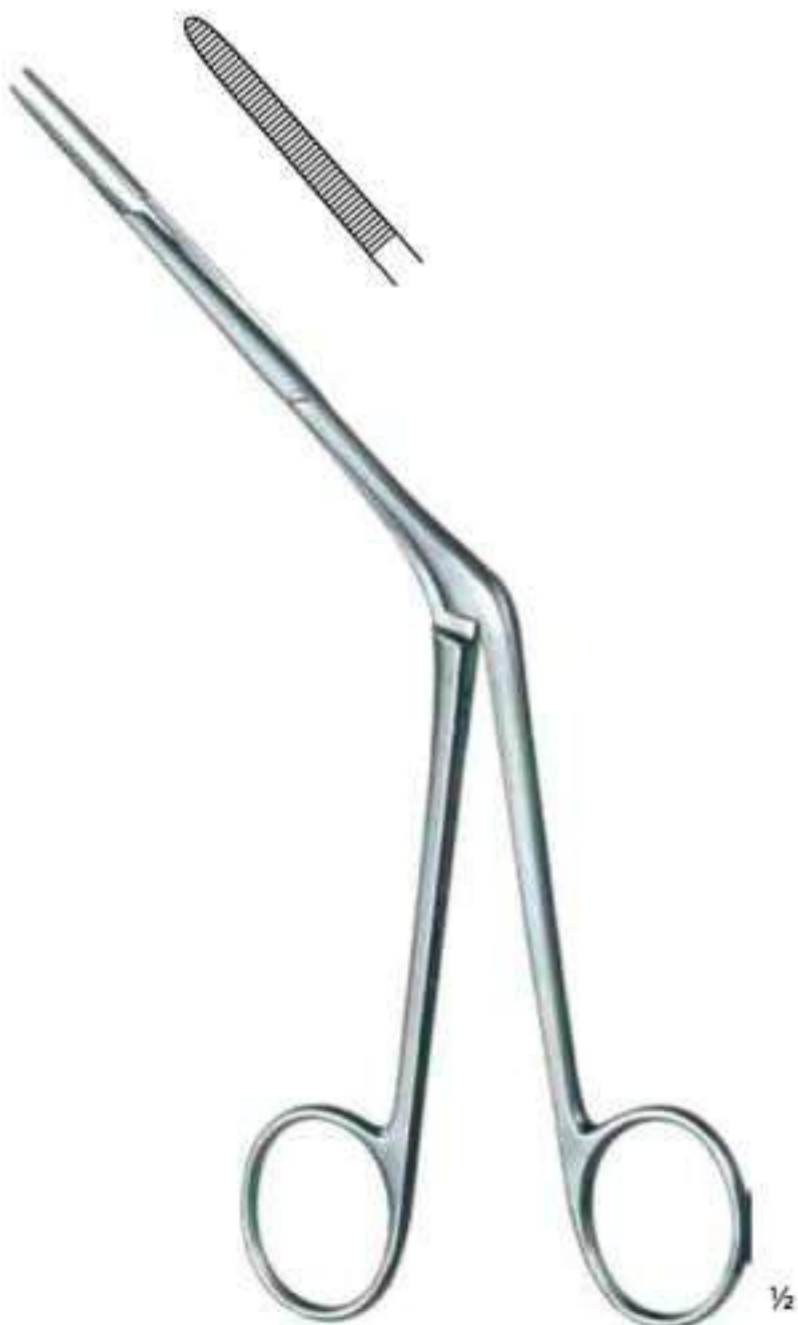

WESTMACOTT
VI-1121-20
20 cm/8"



LUBET-BARBON
VI-1129-20
18.5 cm/7¼"



HARTMANN
VI-1145-20
18.5 cm/7¼"

Nasal polypus forceps



KNIGHT
VI-1207-18
17 cm/6¾"



GRAIG
VI-1213-18
16 cm/6¼"



15.5 cm/6"



LUC
20 cm/8"

VI-1223-01
Fig. 1



BRUENINGS
16.5 cm/6½"



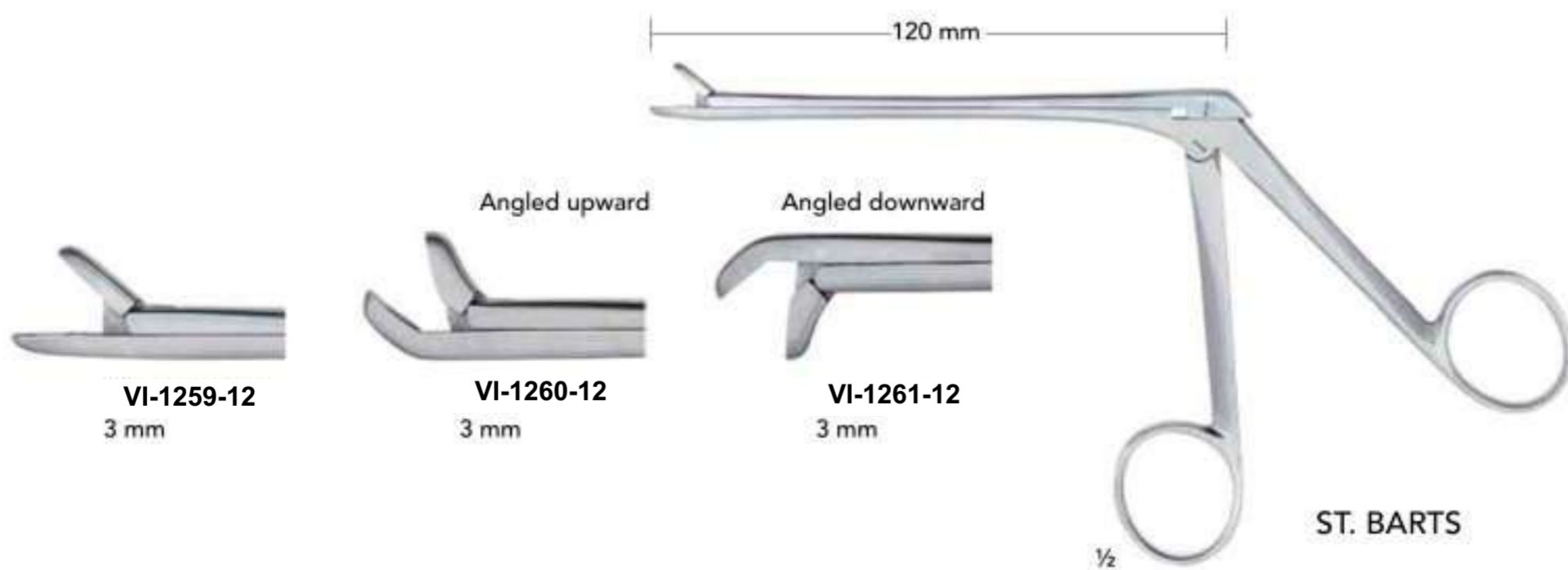
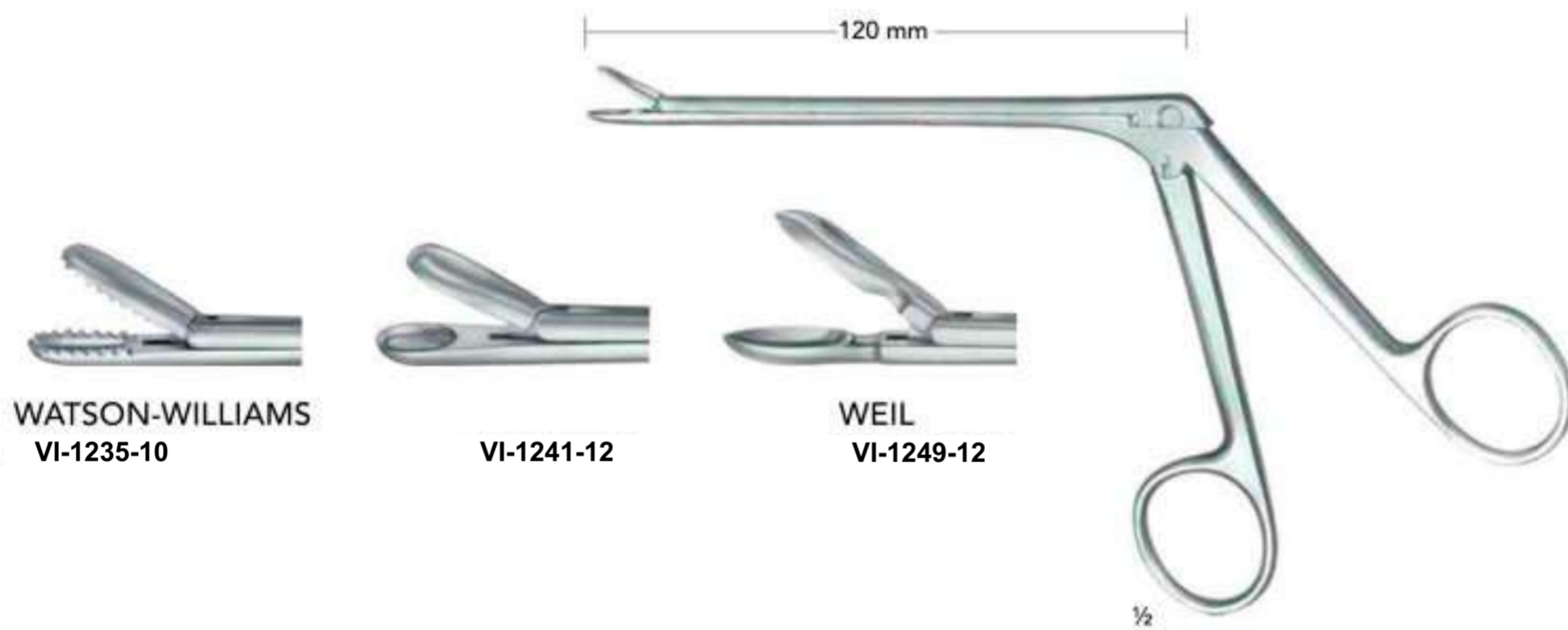
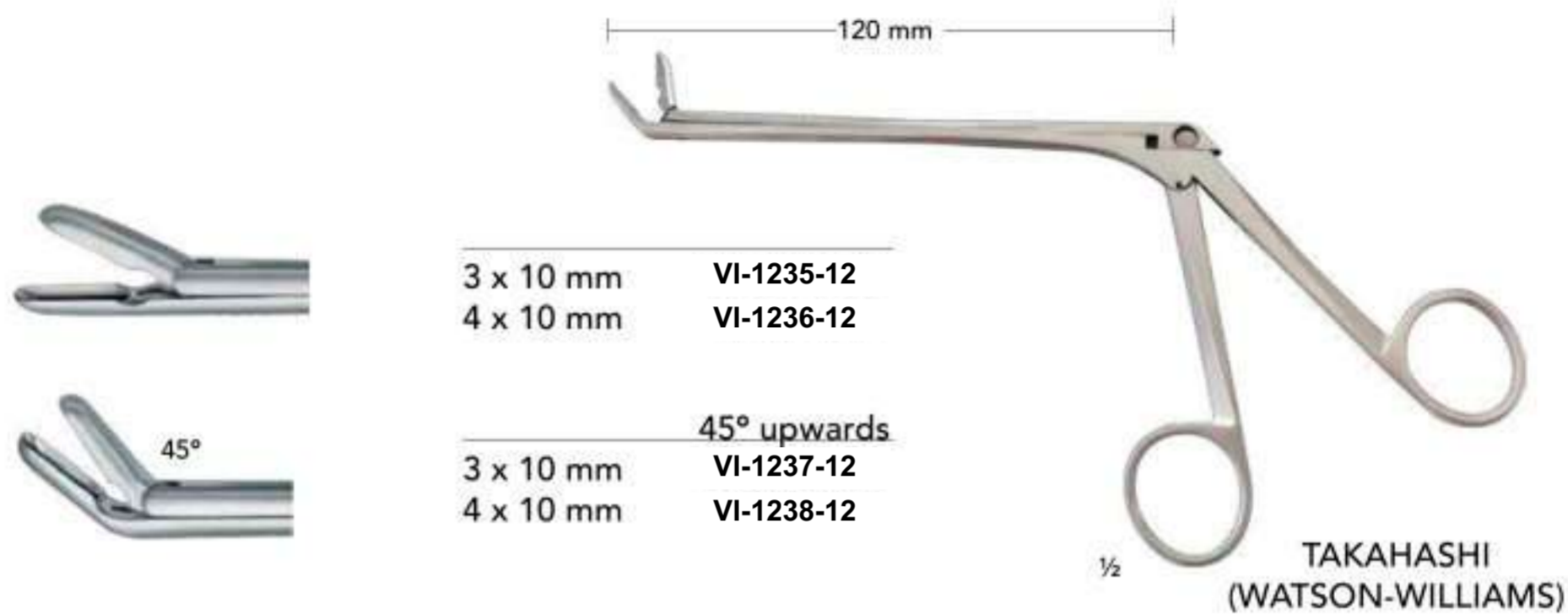

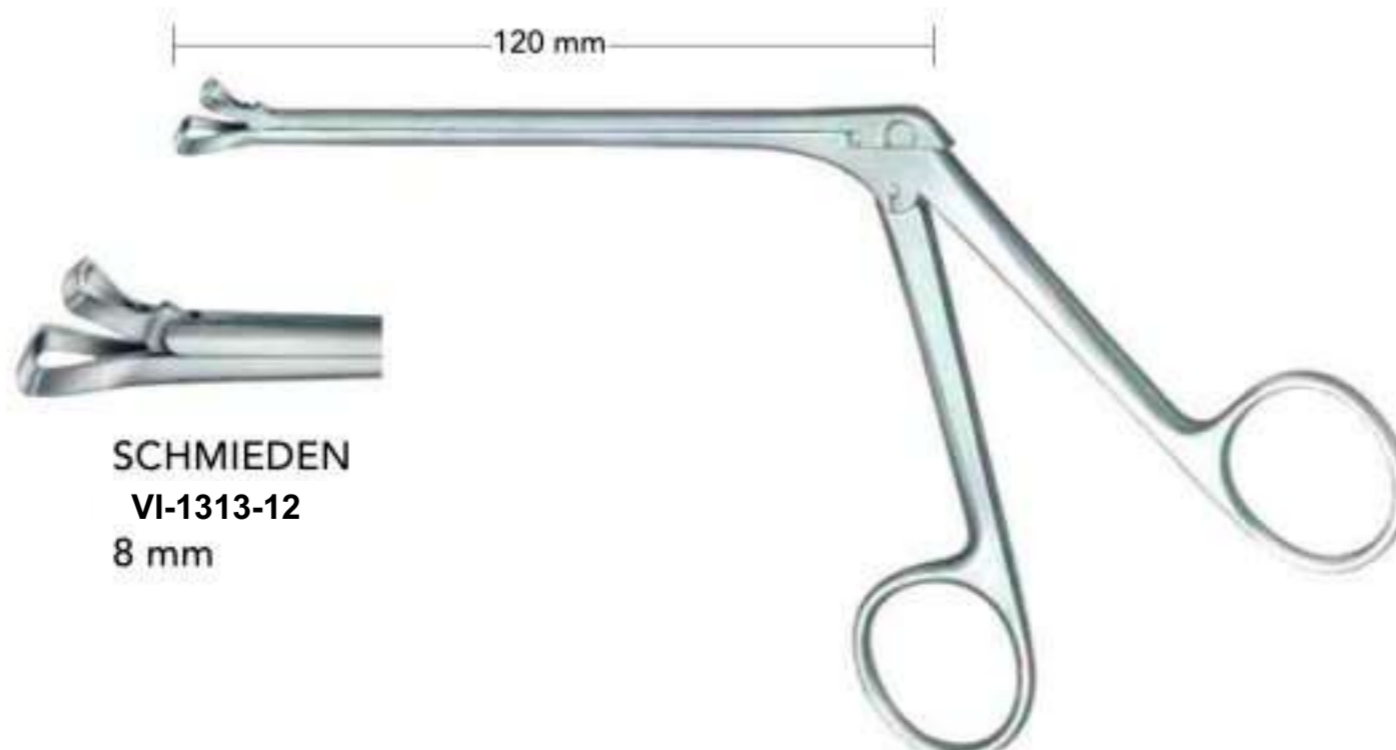
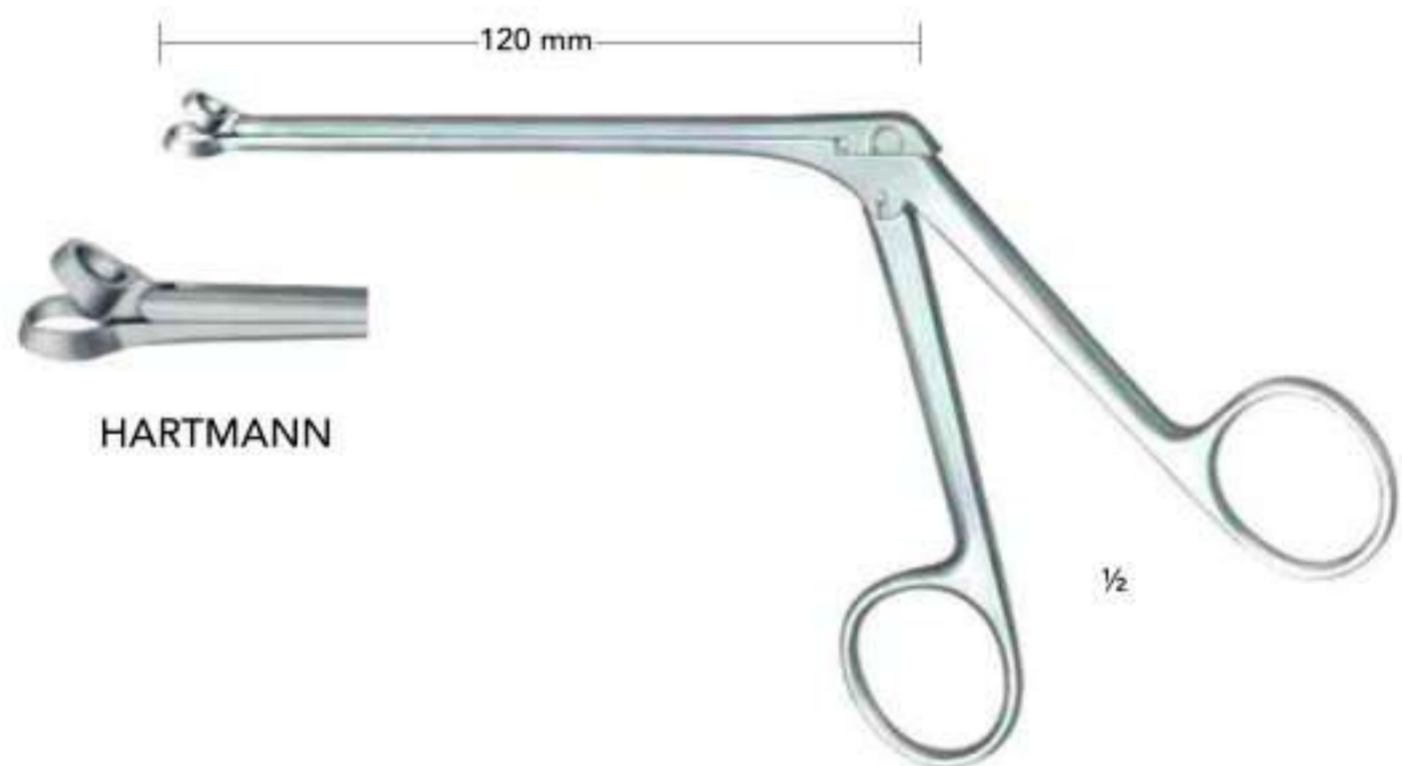
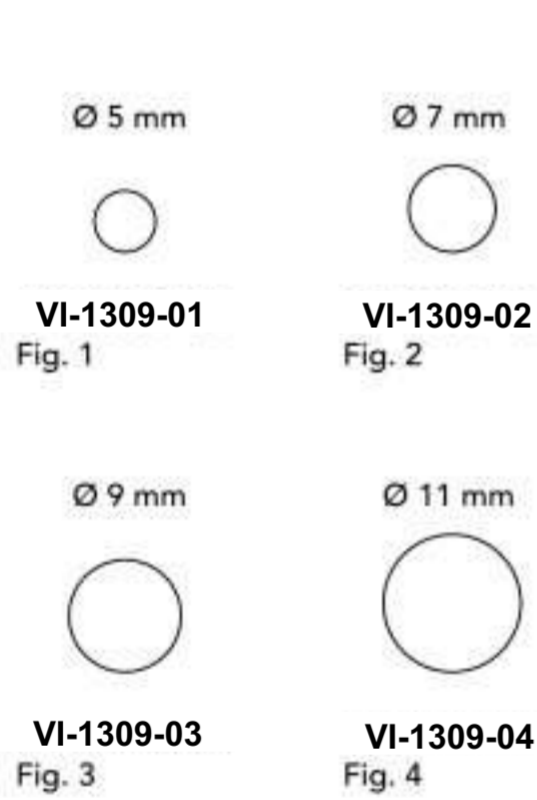
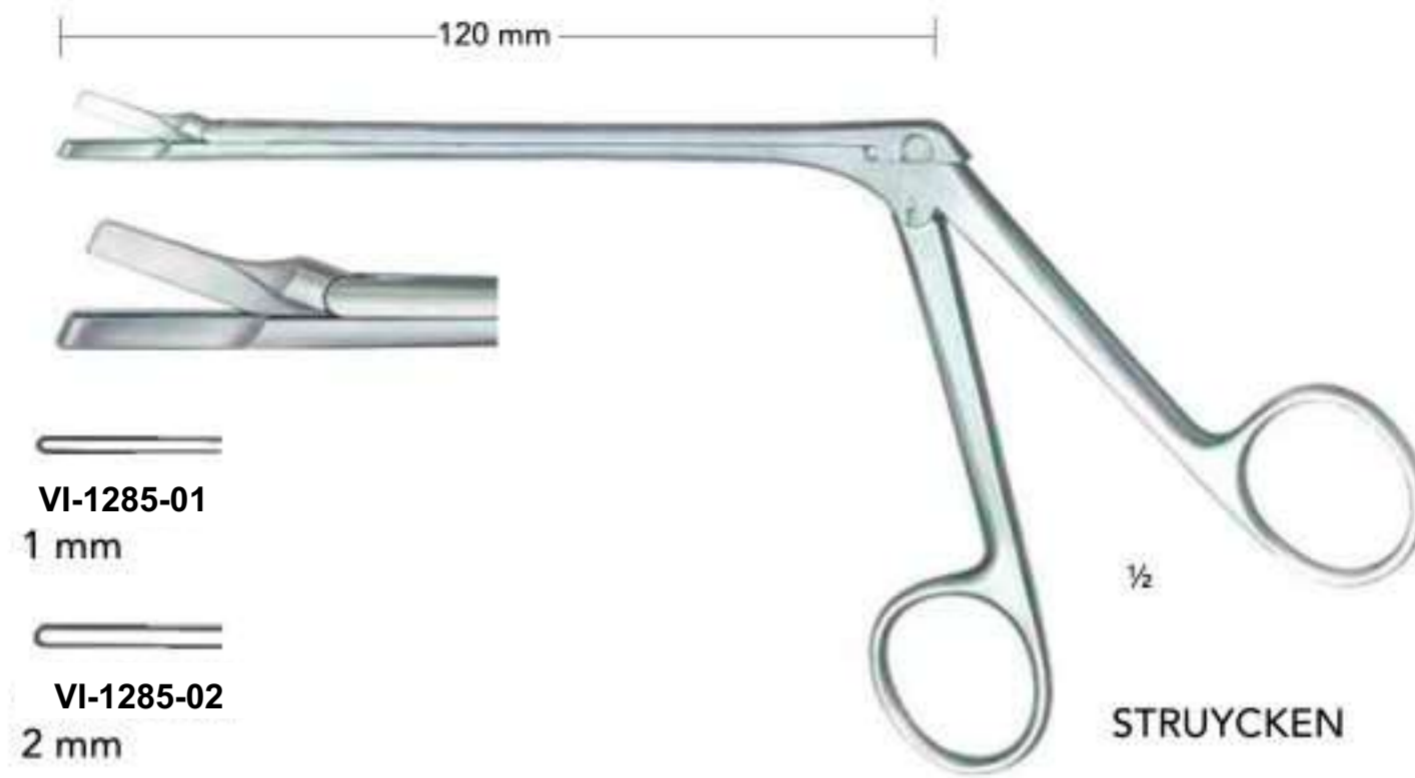

Nasal Cutting Forceps



VI-1255-01
3 mm
Fig. 1



VI-1255-02
3.5 mm
Fig. 2



VI-1255-03
4.5 mm
Fig. 3



VI-1255-04
5.5 mm
Fig. 4



VI-1255-05
6 mm
Fig. 5



VI-1256-01
3 mm
Fig. 1



VI-1256-02
3.5 mm
Fig. 2



VI-1256-03
4.5 mm
Fig. 3



VI-1256-04
5.5 mm
Fig. 4



VI-1256-05
6 mm
Fig. 5



VI-1258-01
3 mm
Fig. 1



VI-1258-02
3.5 mm
Fig. 2



VI-1258-03
4.5 mm
Fig. 3



VI-1258-04
5.5 mm
Fig. 4



VI-1258-05
6 mm
Fig. 5



WEIL-BLAKESLEY



VI-4440-01
3 mm
Fig. 1



VI-4440-02
3.5 mm
Fig. 2



VI-4440-03
4.5 mm
Fig. 3



VI-4440-04
5.5 mm
Fig. 4



VI-4440-05
6 mm
Fig. 5



VI-4441-01
3 mm
Fig. 1



VI-4441-02
3.5 mm
Fig. 2



VI-4441-03
4.5 mm
Fig. 3



VI-4441-04
5.5 mm
Fig. 4



VI-4441-05
6 mm
Fig. 5



BLAKESLEY

180 mm

	90°	90°	40°
	upward cutting	downward cutting	downward cutting
3 mm	VI-1356-17	VI-1357-17	VI-1362-03
5 mm	VI-1360-17	VI-1361-17	VI-1362-05

1/2

FERRIS-SMITH-KERRISON

180 mm

	straight	angled upward	angled downward
2 x 10 mm	VI-1364-02	VI-1365-02	VI-1367-02
3 x 10 mm	VI-1364-03	VI-1365-03	VI-1367-03
4 x 10 mm	VI-1364-04	VI-1365-04	VI-1367-04
5 x 10 mm	VI-1364-05	VI-1365-05	VI-1367-05
6 x 10 mm	VI-1364-06	VI-1365-06	VI-1367-06

30°

1/2

140 mm

90° up	90° down
VI-1342-12	VI-1342-13
3.5 x 3.5 mm	3.5 x 3.5 mm

HAJEK-KOFLER

90° up	90° down
VI-1343-12	VI-1343-13
4 x 4 mm	4 x 4 mm

HAJEK

1/2



KRAUSE
VI-1885-26
26 cm/10¼"



KRAUSE-VOSS
VI-1887-26
26 cm/10¼"

Snare wire, coil of 10 m



½
Ø 0.3 mm VI-1898-30
Ø 0.4 mm VI-1898-40



Snare Wire

½
VI-1899-12
Ø 0.3 mm
Bundle with 12 pieces



Through-cutting



1/2
MIDDLETON-JANSEN
20.5 cm/8 1/4"
4 x 20 mm **VI-1323-19**
5 x 24 mm **VI-1328-19**



1/2
MIDDLETON-JANSEN
VI-1327-19
20 cm/8"

TC Jaws



1/2
VI-1334-21
20 cm/8"

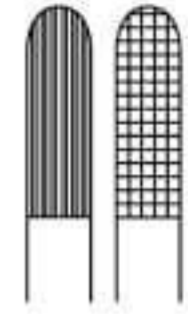

RUBIN
VI-1335-20
20 cm/8"

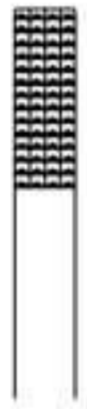

RUBIN
VI-1335-21
18.5 cm/7 1/4"



TC Jaws



RUBIN
VI-1337-21
18.5 cm/7 1/4"

Protection Cap



RUBIN
VI-1335-01



One toothed cutting edge

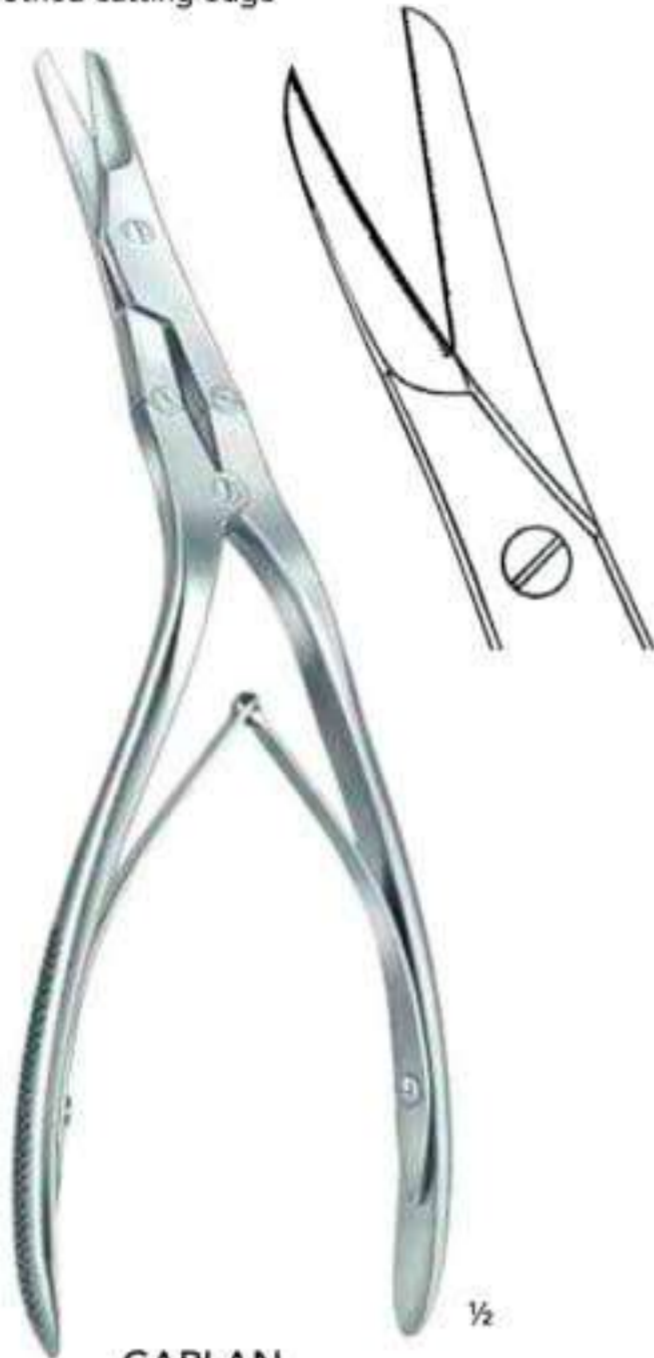

CAPLAN
VI-1331-20
20 cm/8"

Longitudinal Jaw



VI-1500-18

TC Jaws

Morselizer Jaw



VI-1501-18



GUNTER
18 cm/7"

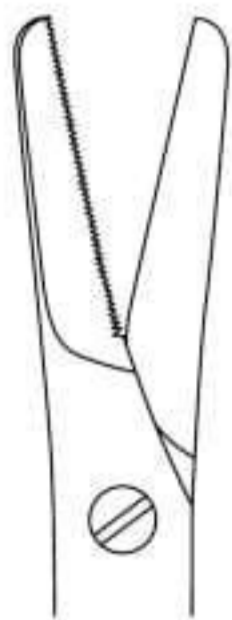

TC Edge



CAPLAN
VI-1799-21
21 cm/8¼"

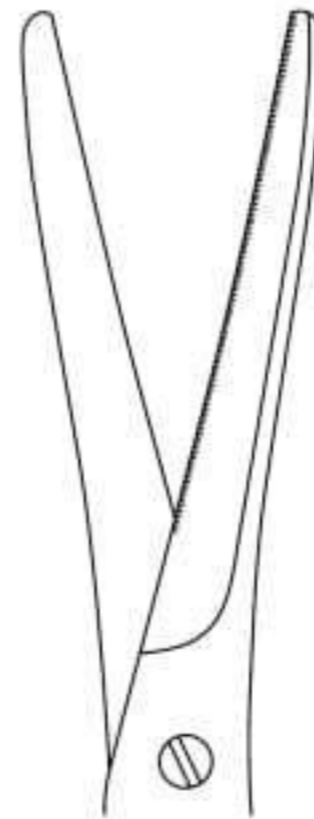

TC Edge

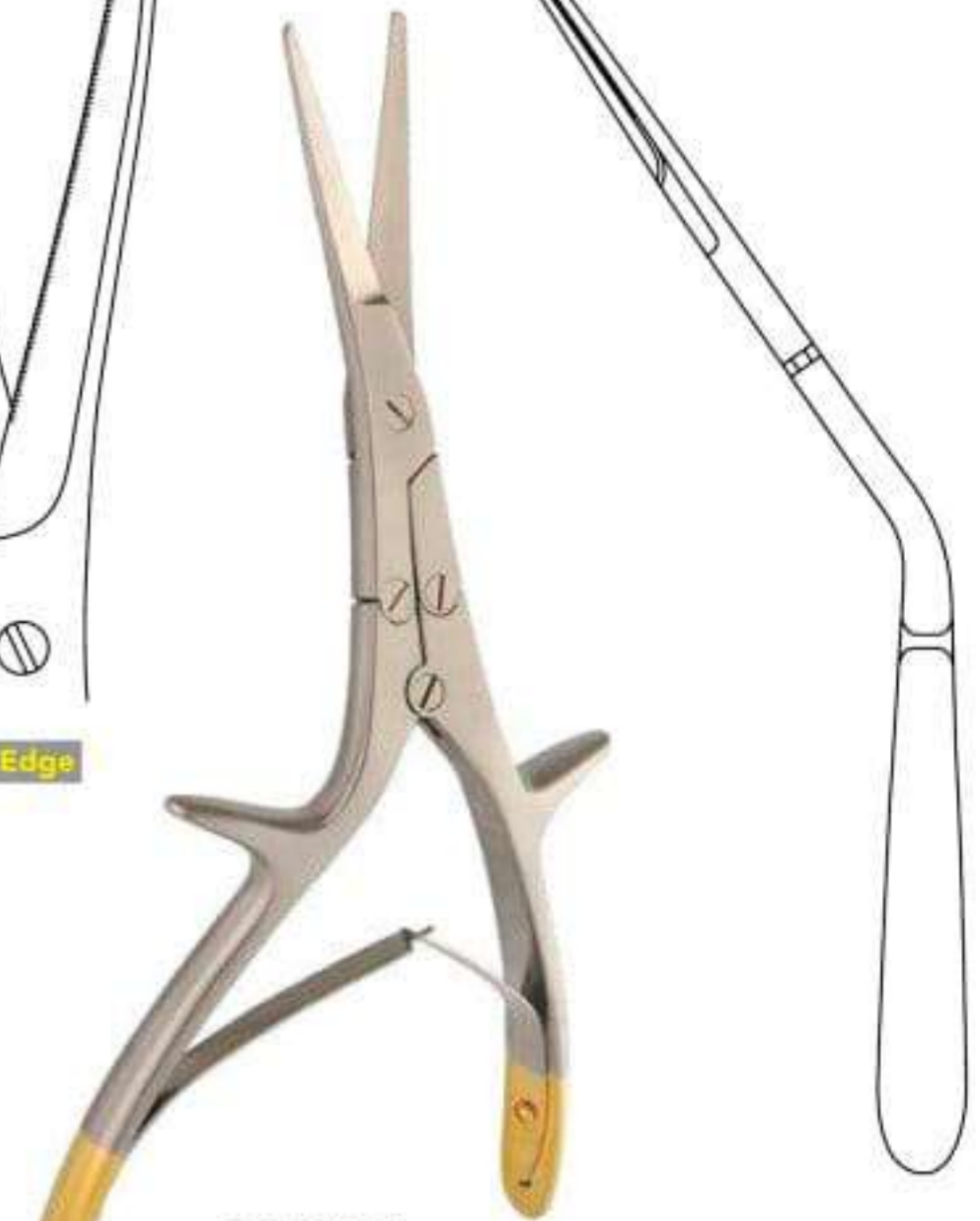

GORNEY
VI-1798-20
20.5 cm/8"



Rhinology

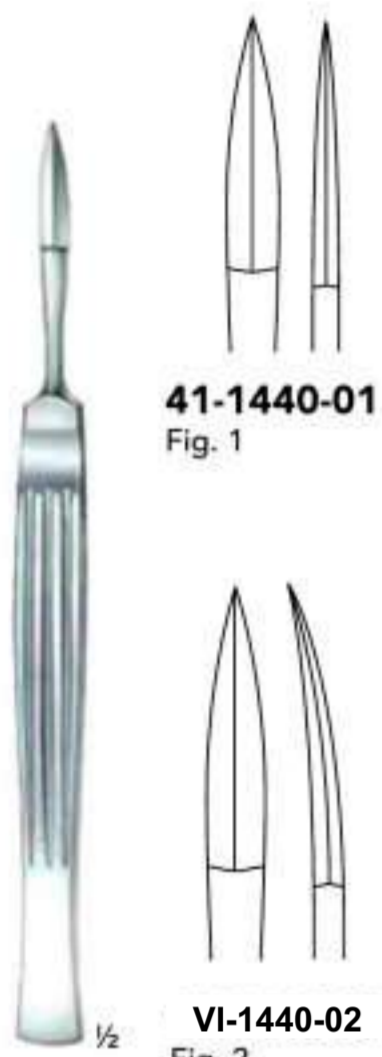

41-1440-01
Fig. 1

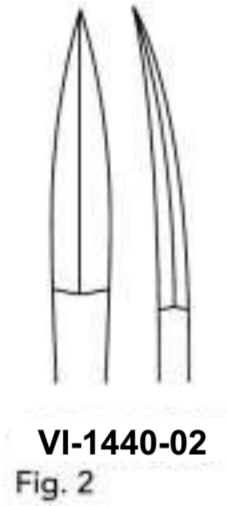

VI-1440-02
Fig. 2

JOSEPH
15 cm/6"



FOMON
VI-1444-16
16.5 cm/6½"



CONVERSE
VI-1459-16
16 cm/6¼"



JOSEPH
VI-1466-15
15.5 cm/6"



COTTLE
VI-1468-15
14 cm/5½"



Mucosa knife
FREER
VI-1484-15
16.5 cm/6½"



FREER
VI-1497-19
19 cm/7½"

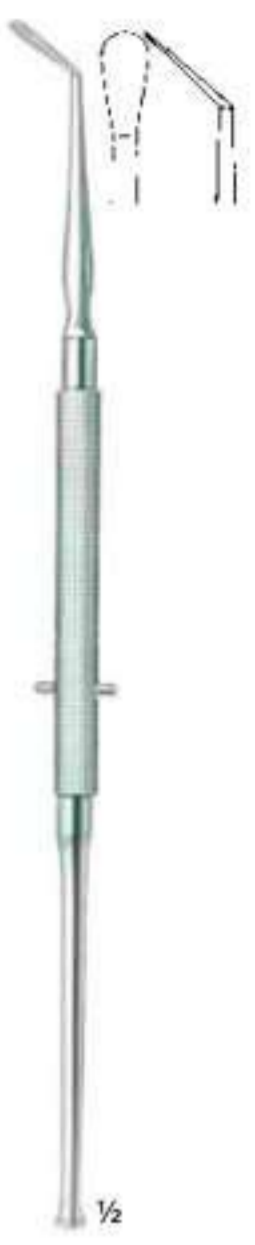

FREER
VI-1499-19
18.5 cm/7¼"



BALLENGER
21 cm/8¼"

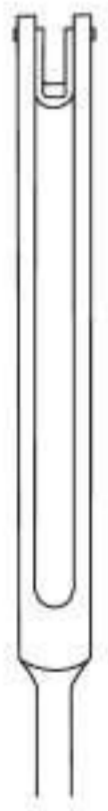

VI-1504-03
3 mm

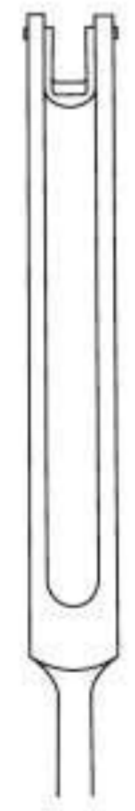

VI-1504-04
4 mm



VI-1504-05
5 mm

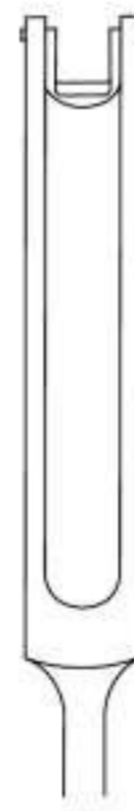

VI-1504-06
6 mm



BALLENGER
21 cm/8¼"



VI-1505-03
3 mm



VI-1505-04
4 mm



VI-1505-05
5 mm



VI-1505-06
6 mm



Rhinology

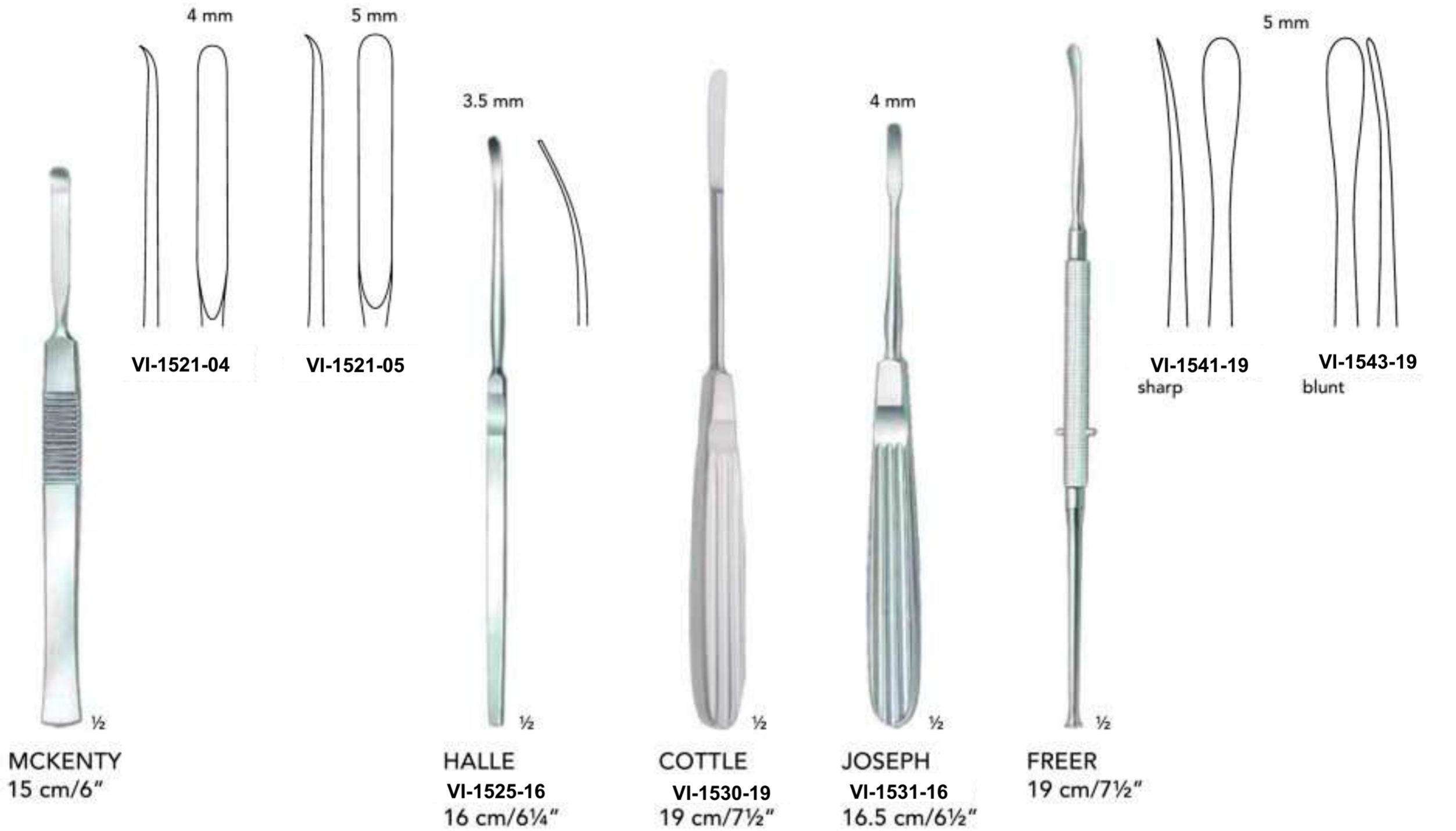

Cleft Palate Periosteal Raspatory

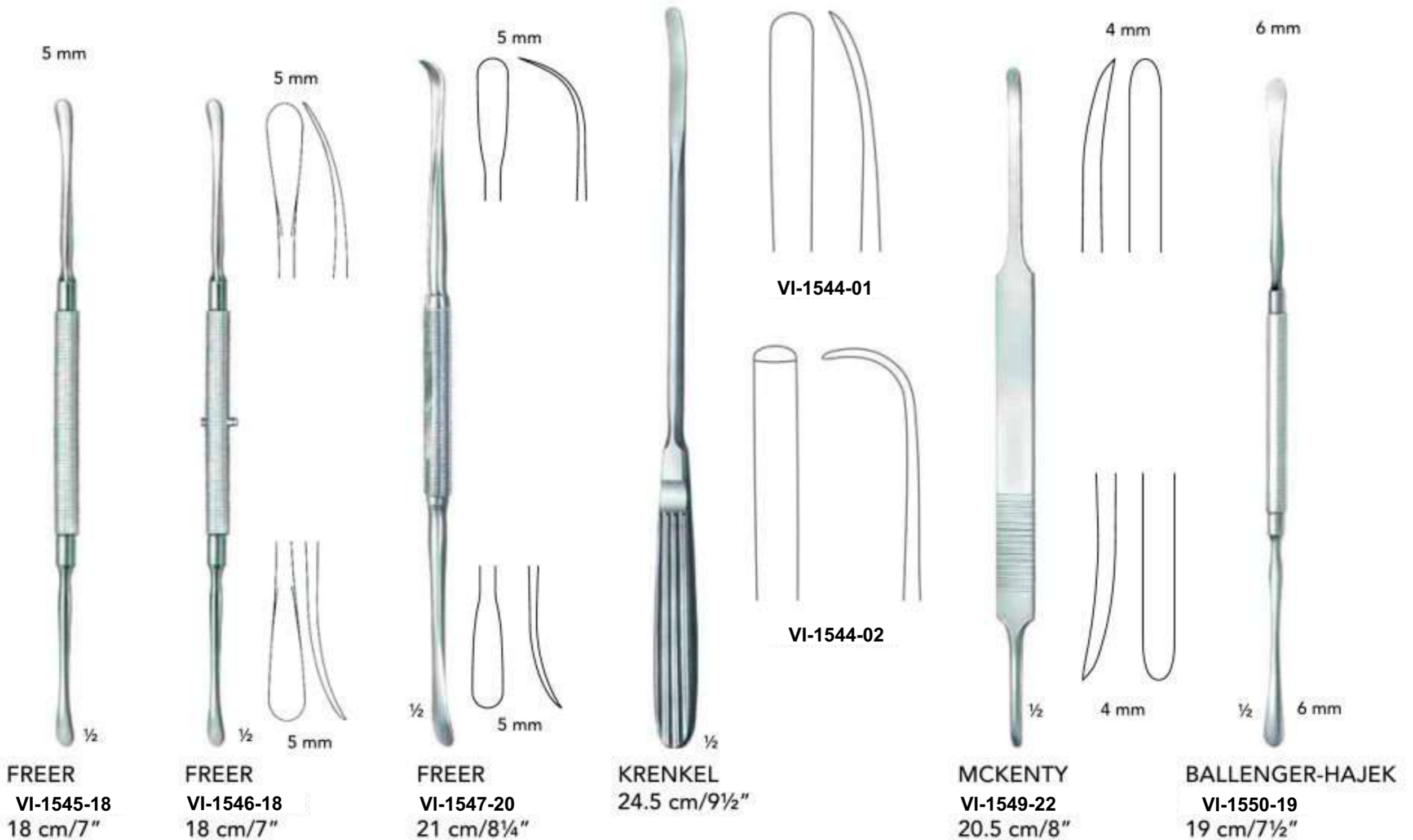



Rhinology



HOWARD
VI-1557-22
21.5 cm/8½"

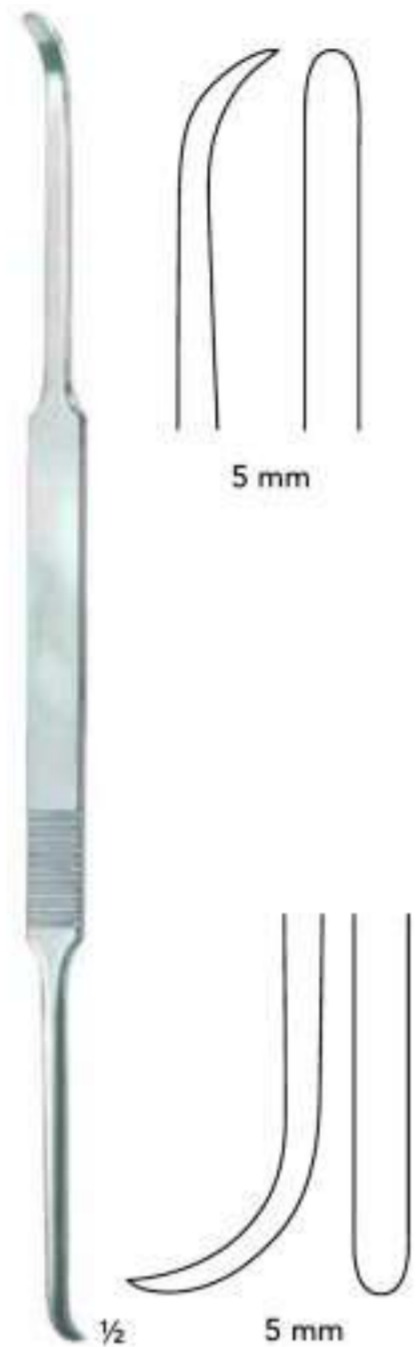

COTTLE
VI-1559-23
23.5 cm/9¼"

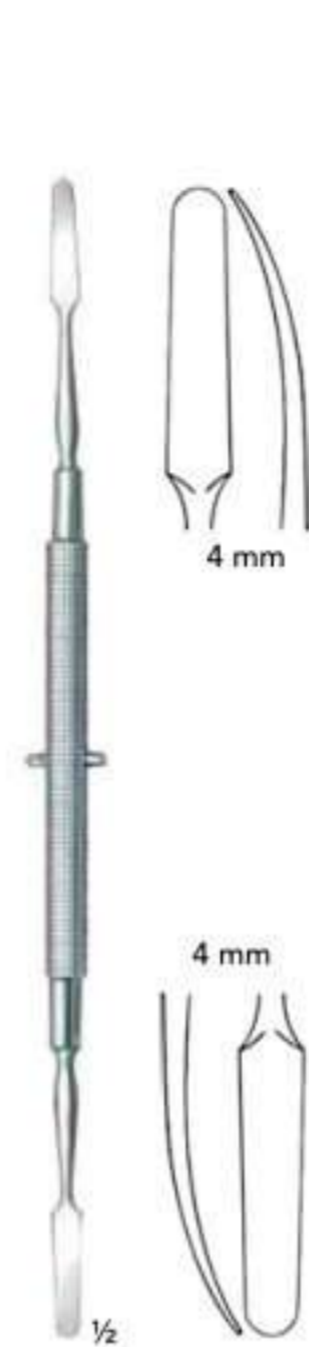

KILLIAN
VI-1560-18
18 cm/7"



KILLIAN
VI-1562-22
23.5 cm/9¼"

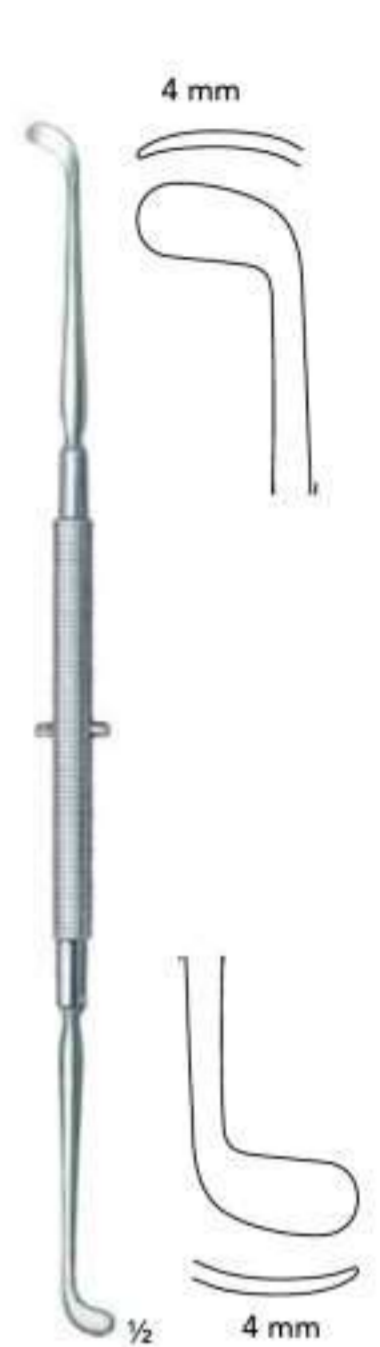

PENNINGTON
VI-1568-21
21 cm/8"

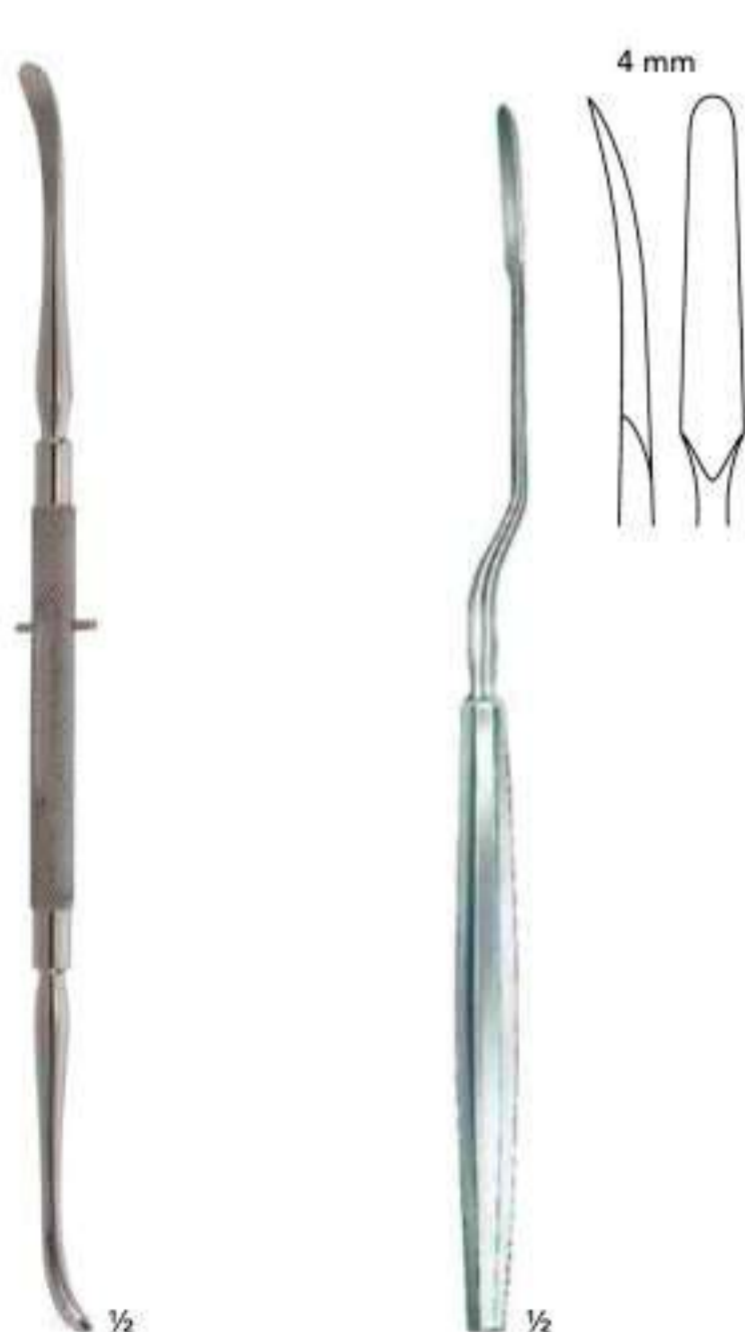

ROGER
VI-1572-19
19 cm/7½"

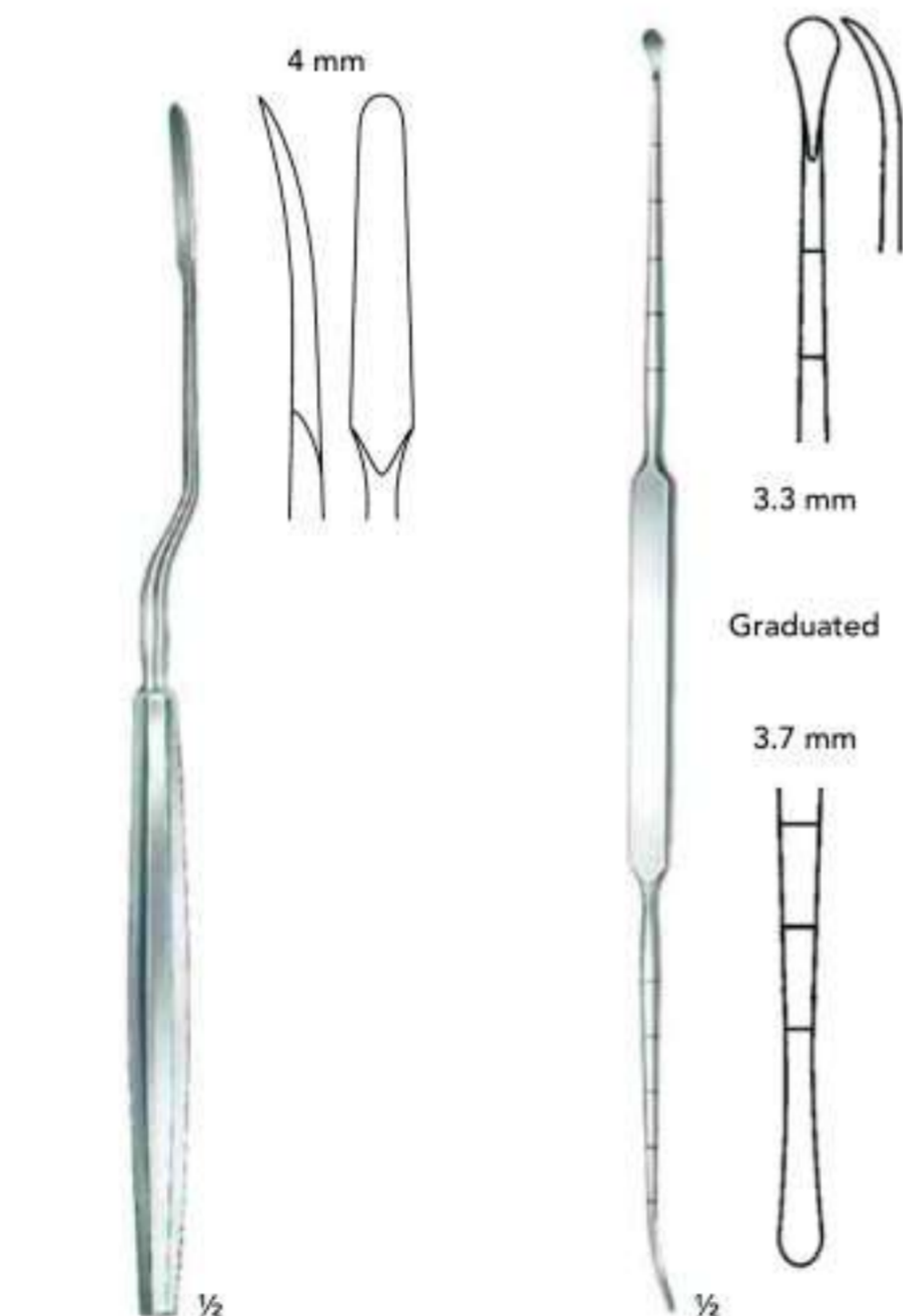

JOSEPH-MASING
VI-1579-22
21.5 cm/8½"

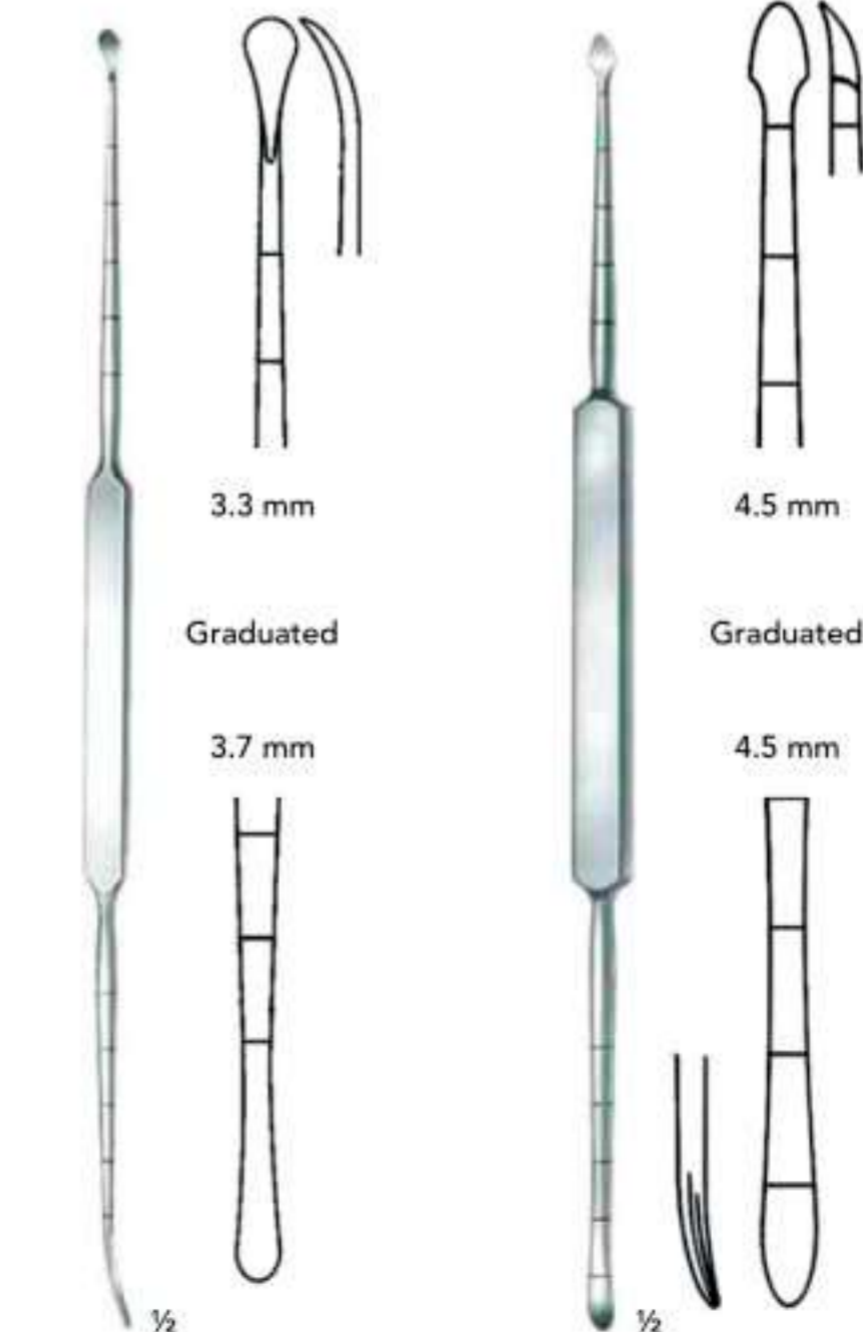

COTTLE
VI-1581-22
23 cm/9"

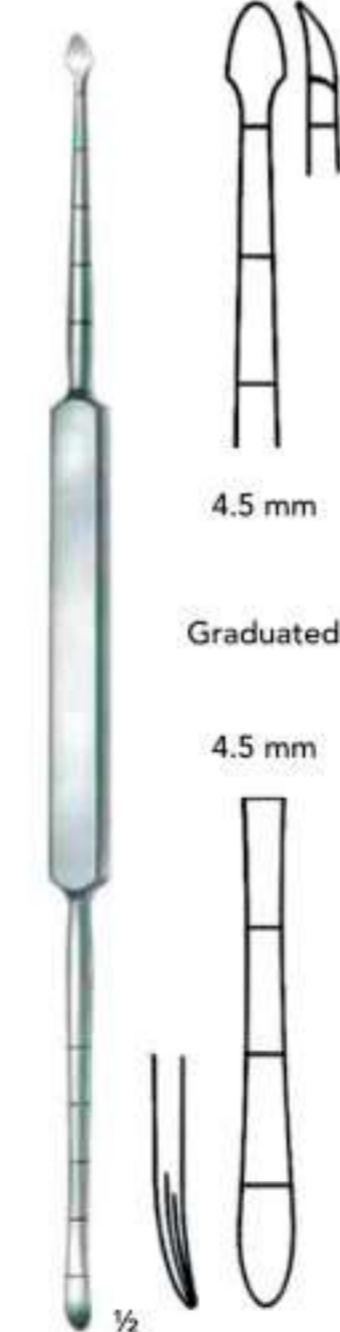

COTTLE
VI-1585-22
23 cm/9"



JOSEPH
VI-1585-16
18 cm/7"



Rhinology

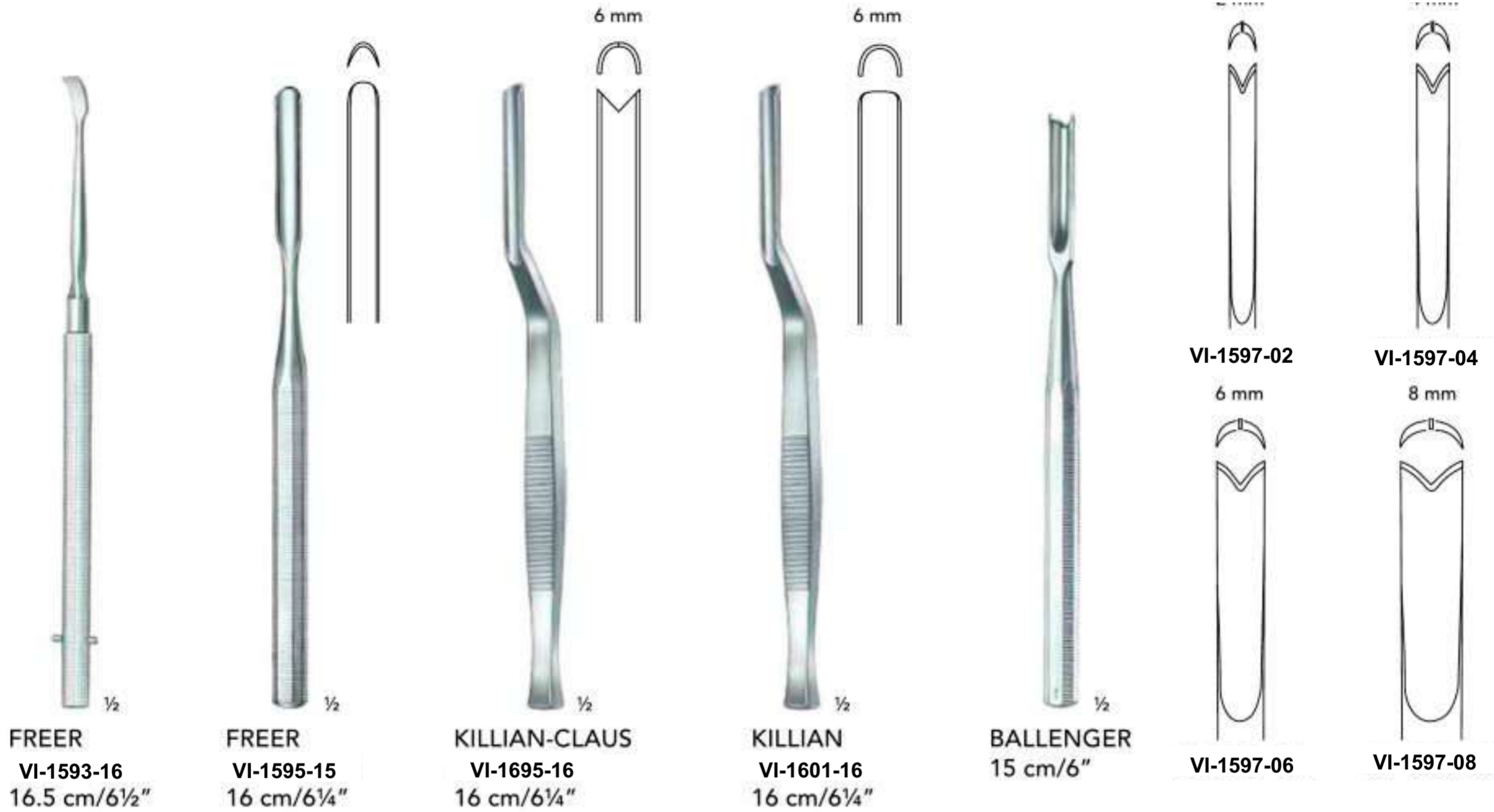

2 mm	VI -1626-02	9 mm	VI -1626-09
3 mm	VI -1626-03	10 mm	VI -1626-10
4 mm	VI -1626-04	11 mm	VI -1626-11
5 mm	VI -1626-05	12 mm	VI -1626-12
6 mm	VI -1626-06	13 mm	VI -1626-13
7 mm	VI -1626-07	14 mm	VI -1626-14
8 mm	VI -1626-08	15 mm	VI -1626-15



6 mm	VI -1616-06
8 mm	VI -1616-08
10 mm	VI -1616-10
11 mm	VI -1616-11
12 mm	VI -1616-12
14 mm	VI -1616-14
16 mm	VI -1616-16



2 mm	VI -1606-02
4 mm	VI -1606-04
6 mm	VI -1606-06
7 mm	VI -1606-07
8 mm	VI -1606-08
9 mm	VI -1606-09
10 mm	VI -1606-10
12 mm	VI -1606-12



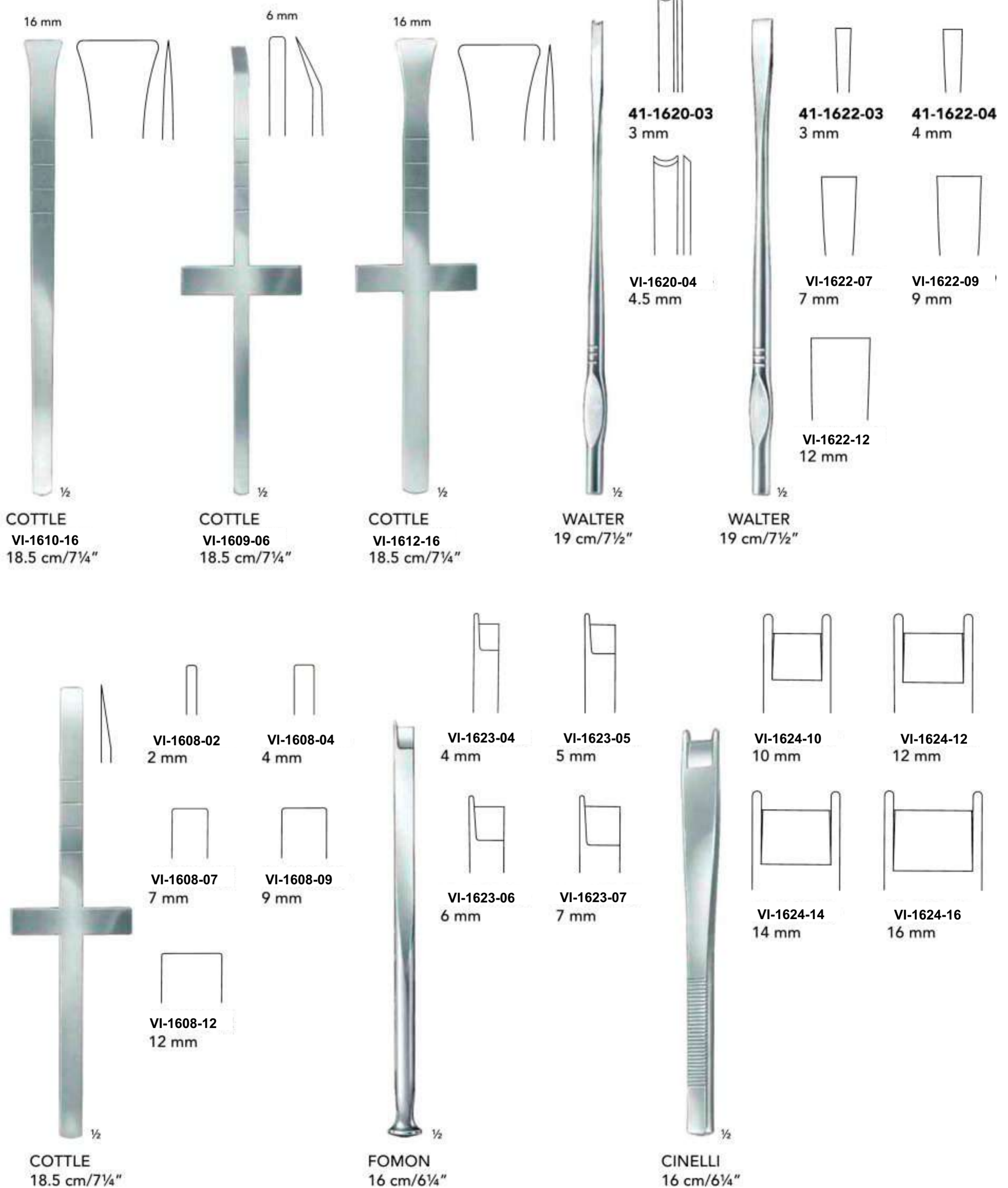

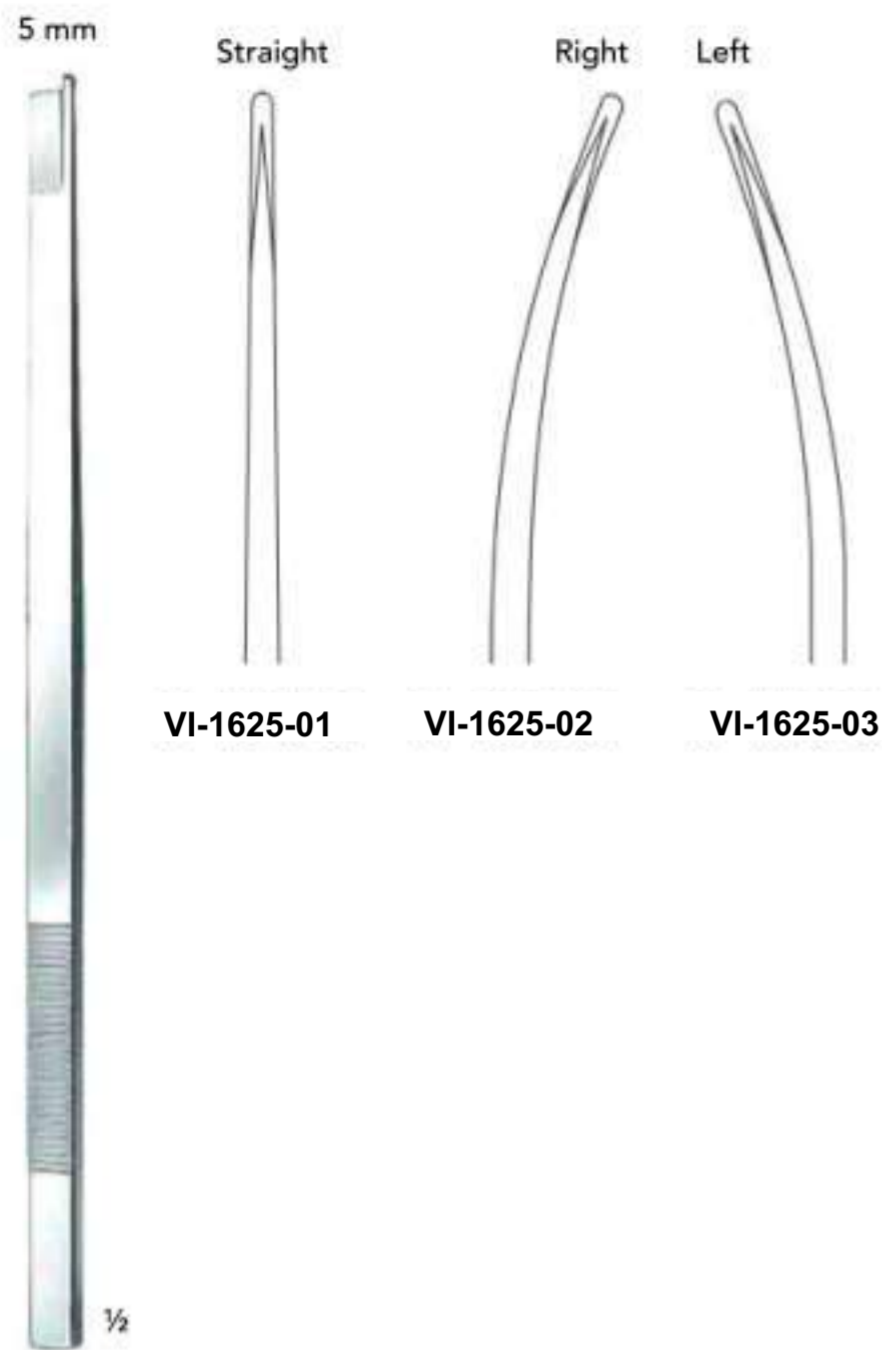

NEIVERT-ANDERSON
20.5 cm/8"

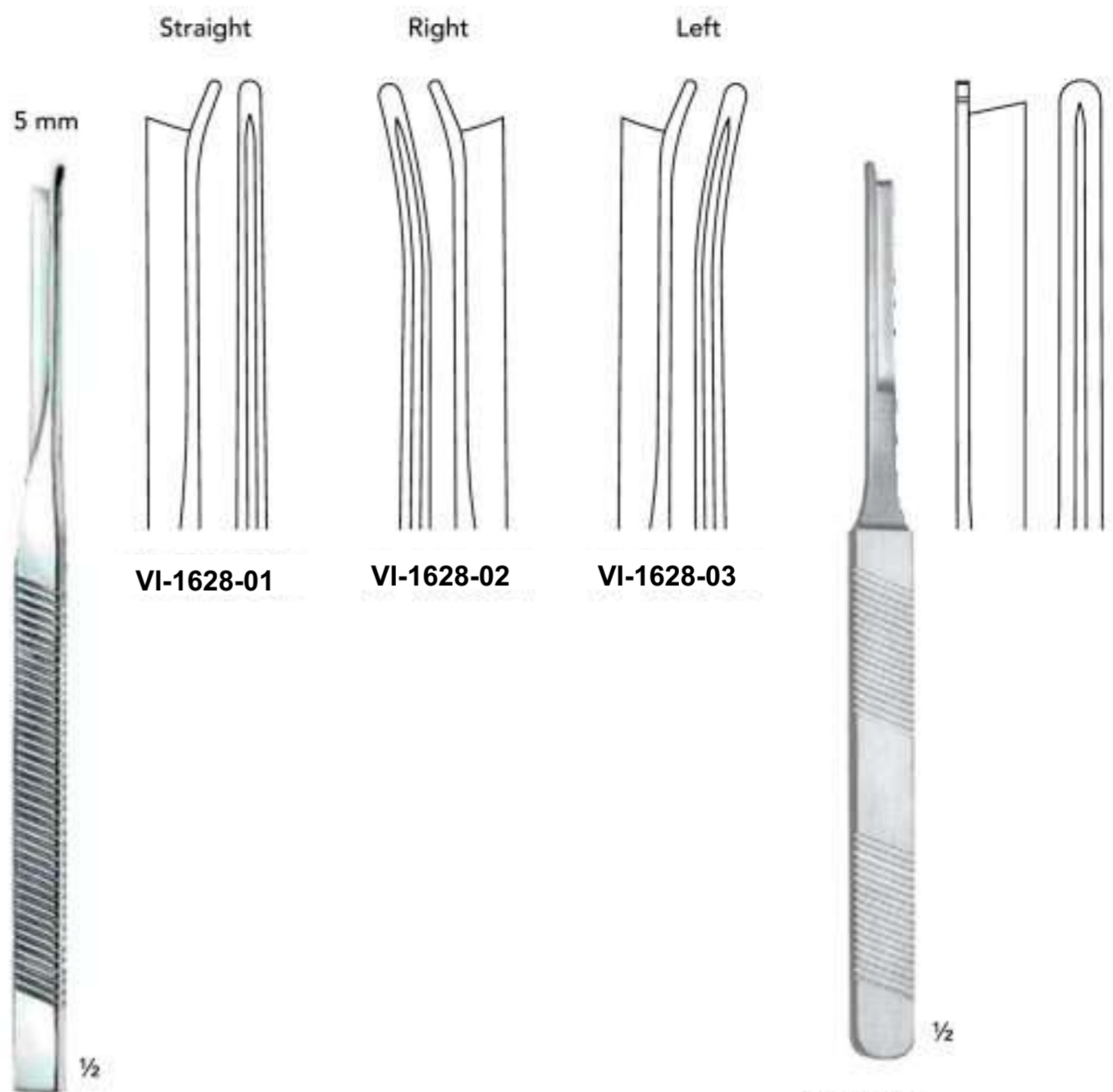

SILVER
18 cm/7"

PARKES
VI-1629-01
18 cm/7"

Nasal Saws



JOSEPH



VI-1649-00
19 cm/7 1/2"

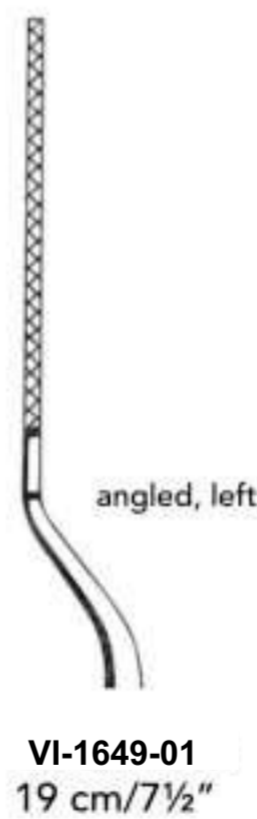

VI-1649-01
19 cm/7 1/2"



VI-1649-02
19 cm/7 1/2"

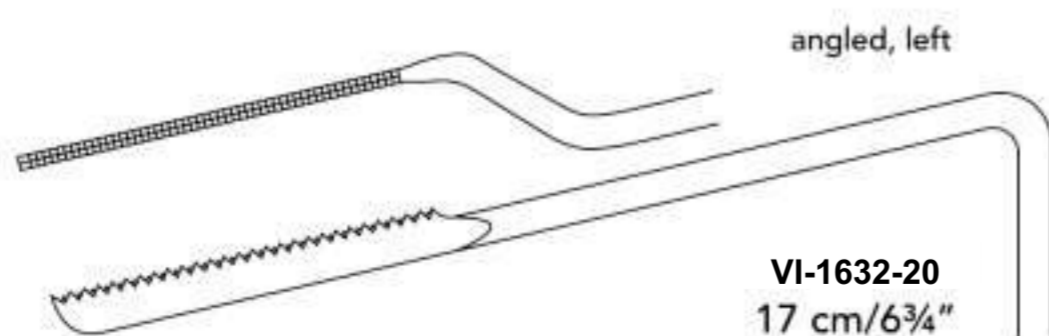

VI-1632-20
17 cm/6 3/4"

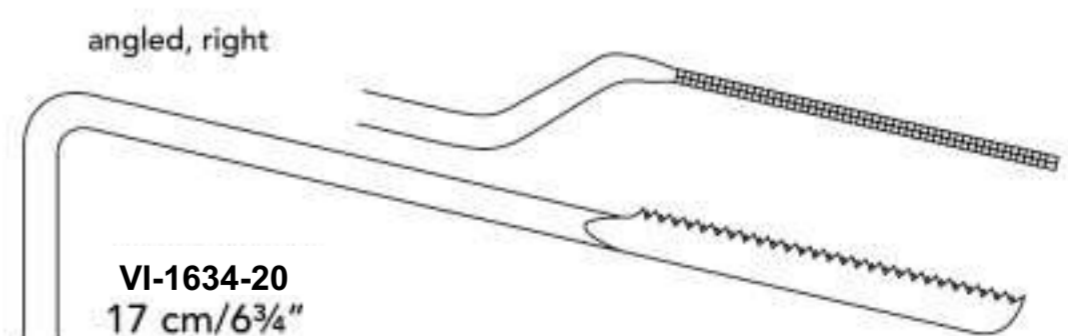

VI-1634-20
17 cm/6 3/4"

Drawing cut

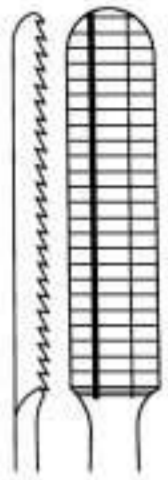

VI-1656-01

Pushing cut

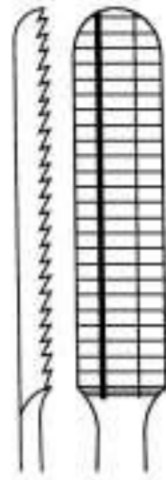

VI-1656-02

Pushing cut

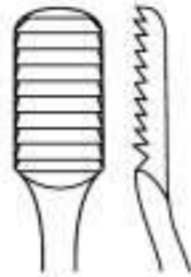

VI-1674-18

Drawing cut

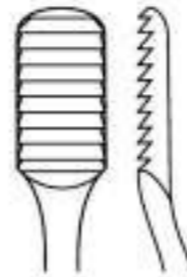

VI-1676-18

45 x 6 mm



VI-1669-02



VI-1669-03



VI-1669-01

MALTZ
17 cm/6³/₄"

LEWIS
19 cm/7¹/₂"

GALLAHER
17 cm/6³/₄"

34 x 8 mm

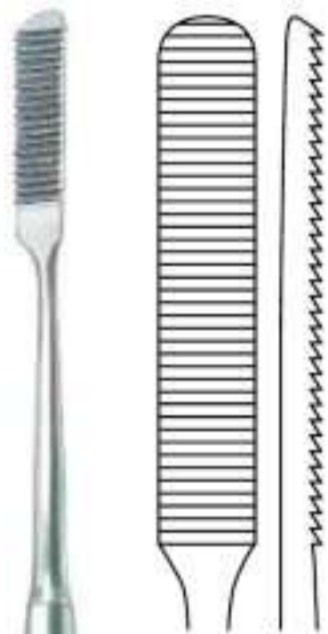

COTTLE
VI-1670-21
21 cm/8¹/₄"

32 x 9 mm

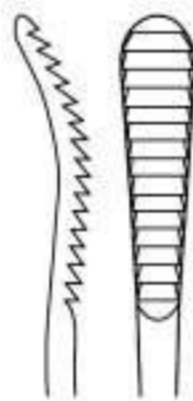

VI-1671-21

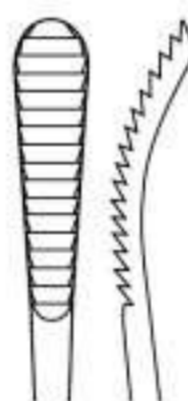

VI-1673-21

AUFRICHT
21 cm/8¹/₄"



AUFRICHT (GLABELLA)
20 cm/8"

	Downward	Upward
4 mm	VI-1674-04	VI-1675-04
7 mm	VI-1674-07	VI-1675-07

TC Jaws



AUFRICHT (GLABELLA)

VI-1800-21
21 cm/8¹/₄"



JOSEPH
VI-1685-01
16 cm/6¼"

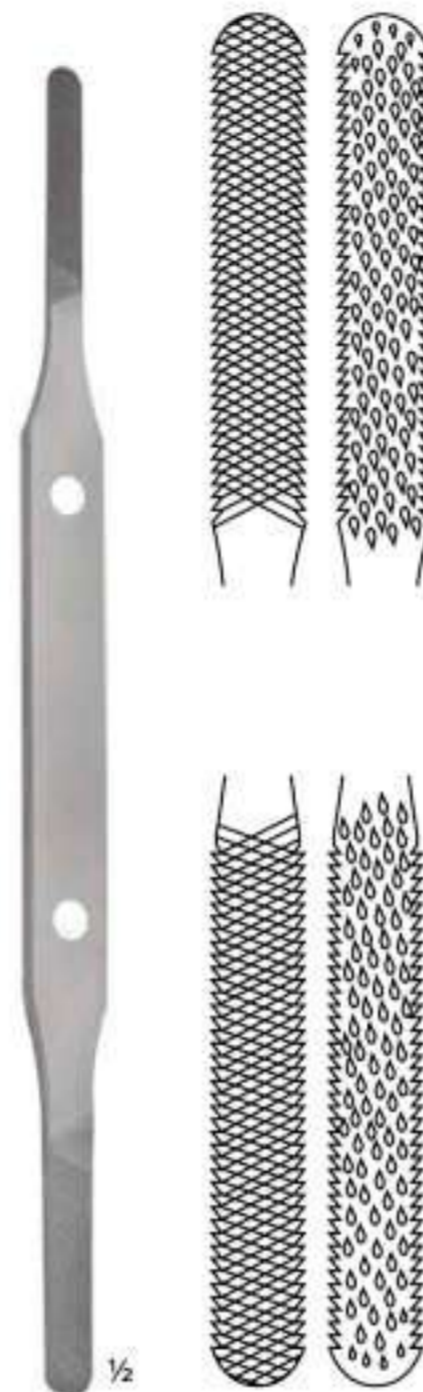

FOMON
21.5 cm/8½"

Fine	Coarse
VI-1684-21	VI-1685-21

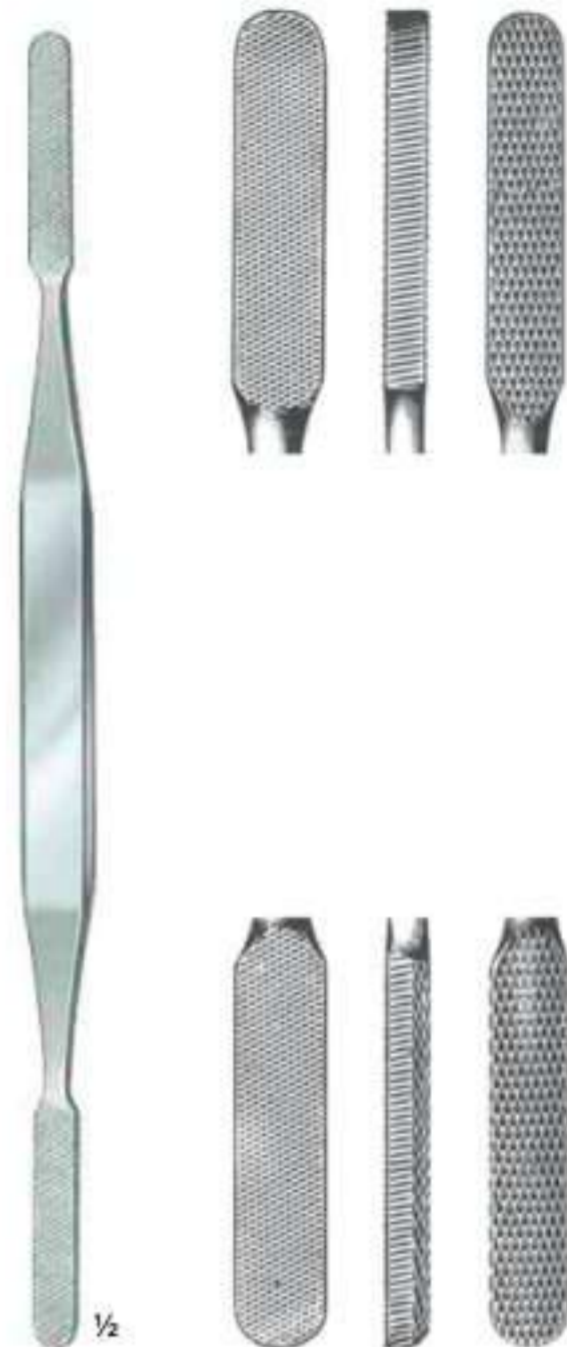

FOMON
VI-1680-21
20.5 cm/8"



Cartilage Crusher

COTTLE

Smooth Bed	VI-1652-00
Serrated Bed	VI-1652-01



TOLSDORF

Smooth Bed	VI-1653-00
Serrated Bed	VI-1653-01

Guide Support for osteotomes



7 mm wide

COTTLE
VI-1650-02
7 mm



Handle for
VI-1650-02

COTTLE
VI-1650-01
12 cm/4¾"

TC Jaws



1/2
FOMON
20 cm/8"

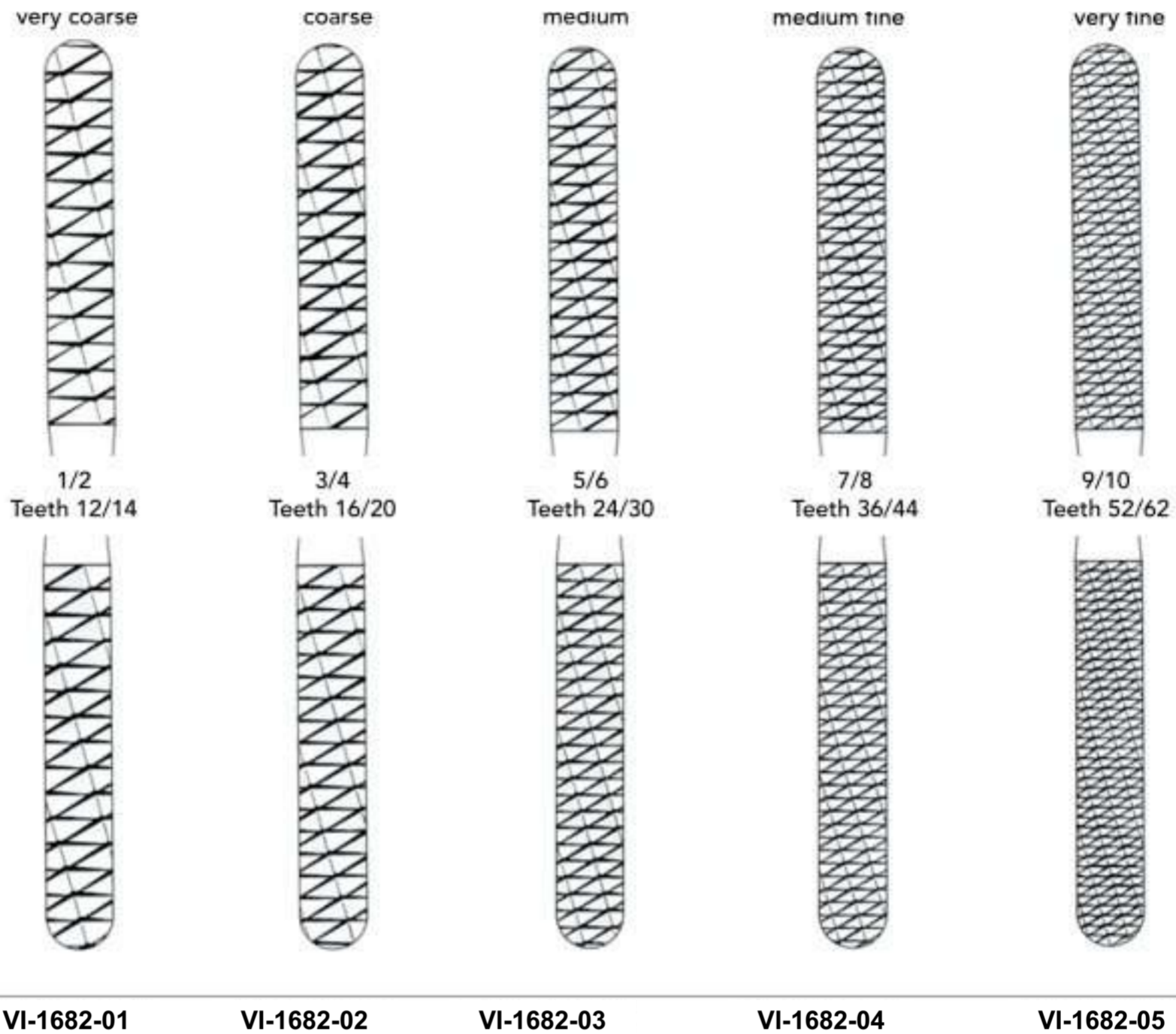

TC Jaws



1/2
PARKES
21 cm/8 1/4"

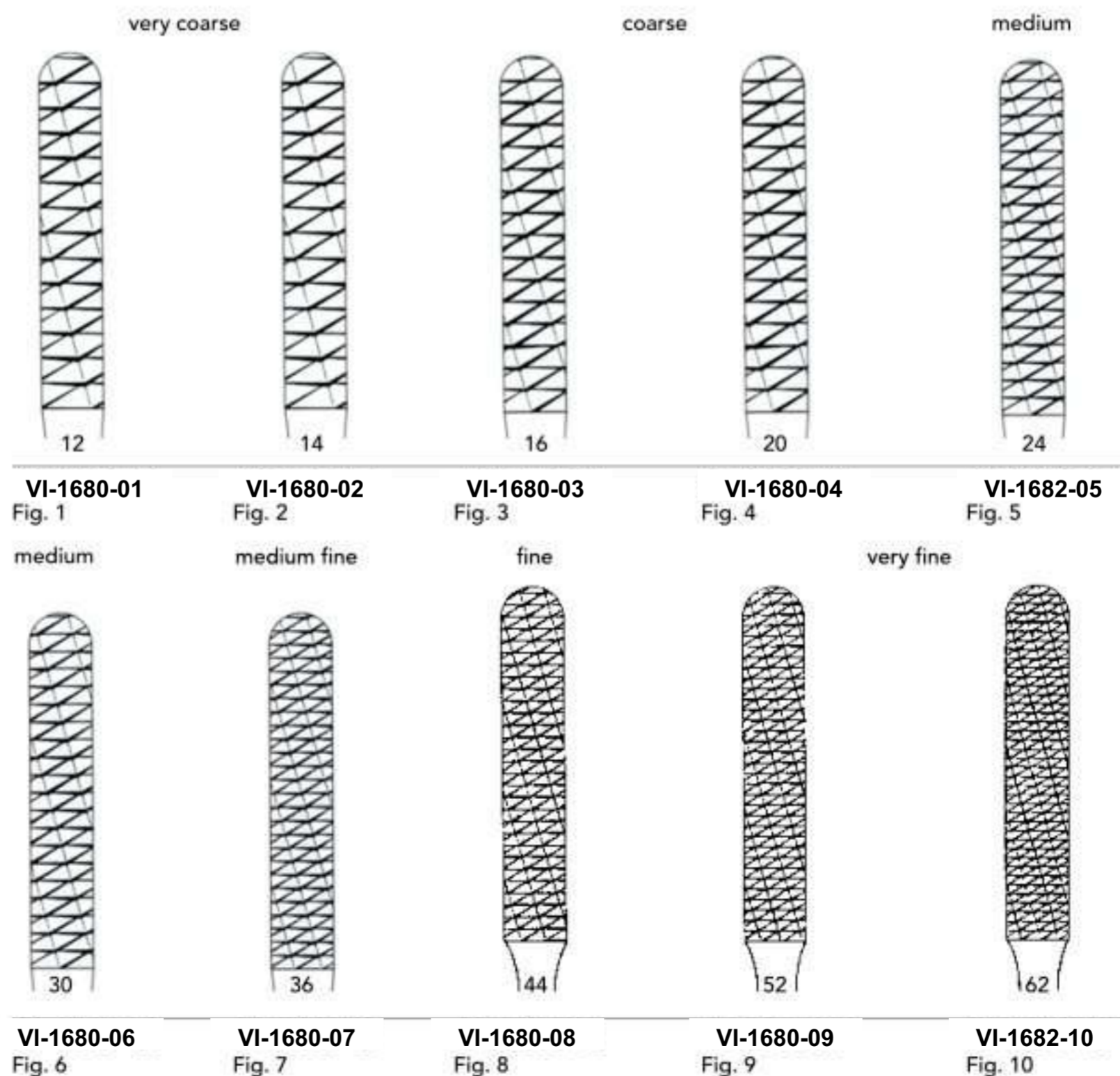

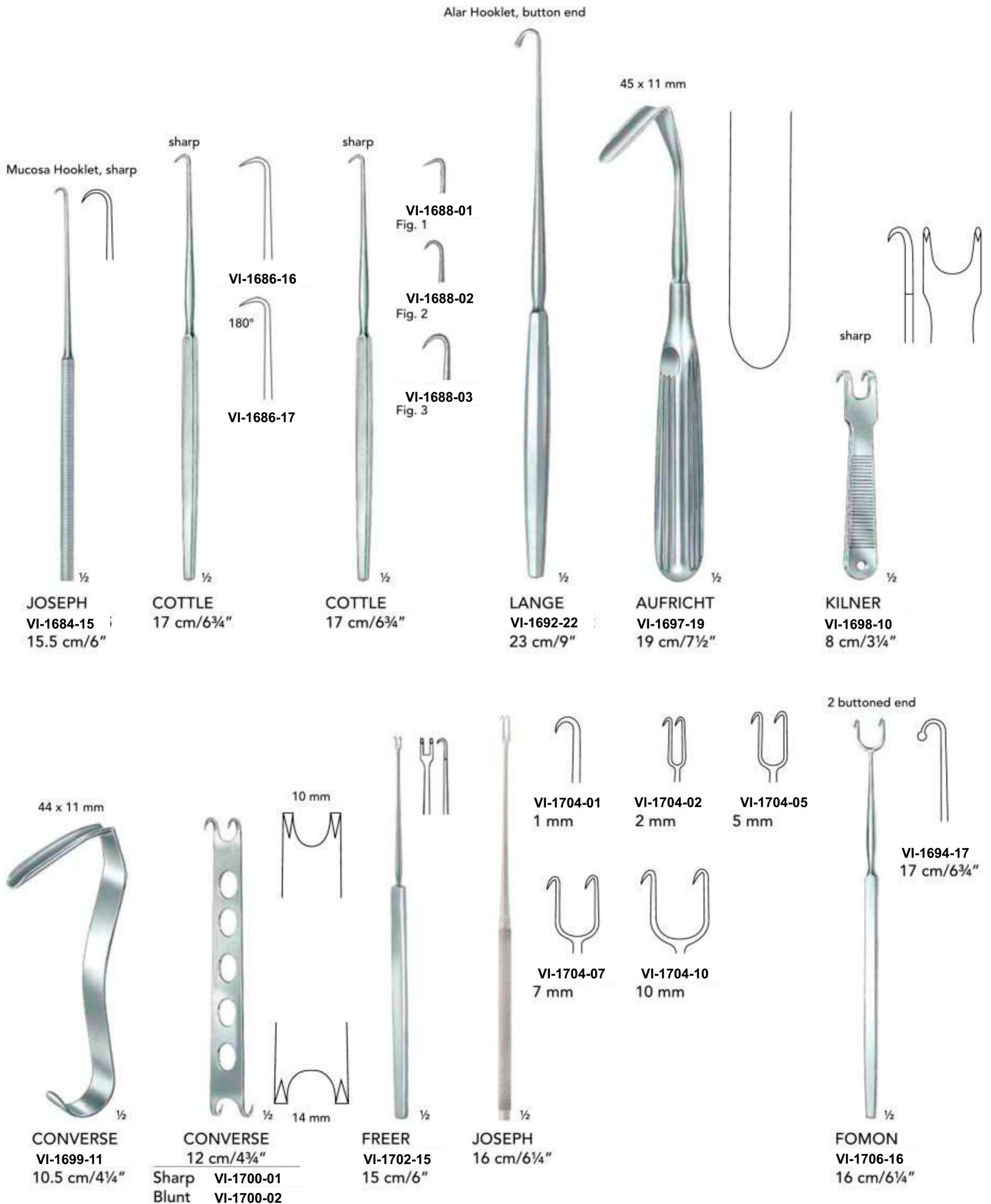



COTTLE-NEIVERT
VI-1707-20
19.5 cm/7¾"



COTTLE
19.5 cm/7¾"



COTTLE
VI-1710-14
14 cm/5½"



NEIVERT
VI-1712-16
17 cm/6¾"

Saddle Hook



COTTLE
VI-1713-15
14 cm/5½"



COTTLE
VI-1714-15
16 cm/6¼"



AUFRICHT
VI-1715-14
12 cm/4¾"



OGURA
VI-1728-11
11 cm/4¼"



COTTLE
VI-1731-14
14 cm/5½"

Columella Forceps
12 mm



COTTLE
VI-1732-10
11 cm/4¼"



COAKLEY
17 cm/6¾"

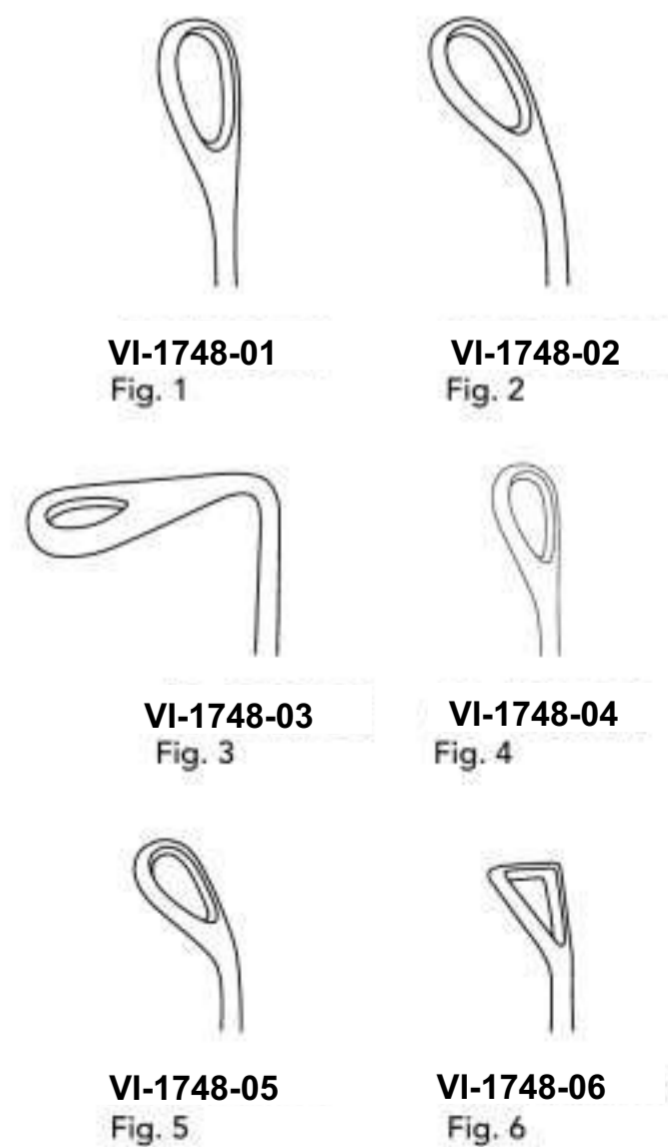

VI-1748-01
Fig. 1

VI-1748-02
Fig. 2

VI-1748-03
Fig. 3

VI-1748-04
Fig. 4

VI-1748-05
Fig. 5

VI-1748-06
Fig. 6



GORNEY
19 cm/7½"

- 3 mm VI-1570-03
- 4 mm VI-1570-04



GUILLEN
VI-1840-20
19 cm/7½"

VI-1840-90
Obturator



RITTER-HALLE
19 cm/7½"

41-1842-30
Ø 3 mm

41-1842-40
Ø 4 mm



FAULKNER
VI-1842-21
21 cm/8¼"



Fig.

1	13 mm	KI-1755-01
2	15 mm	KI-1755-02
3	17 mm	KI-1755-03
4	19 mm	KI-1755-04
5	21 mm	KI-1755-05
6	23 mm	KI-1755-06

BECKMANN
22 cm/8¾"



Fig.

1	13 mm	KI-1756-01
2	15 mm	KI-1756-02
3	17 mm	KI-1756-03
4	19 mm	KI-7756-04
5	21 mm	KI-1756-05
6	23 mm	KI-1756-06

BECKMANN
21.5 cm/8½"



KRESSNER
VI-1721-20
22 cm/8¾"



COTTLE-WALSHAM
16 cm/6¼"



VI-1724-01
Straight



VI-1724-02
Left



VI-1724-03
Right



ASCH
VI-1725-23
22.5 cm/9"



VASE **INSTRUMENTS**
PREMIUM QUALITY INSTRUMENTS

Sinus Surgery

- Antrum Cannula
- Antrum Curettes
- Antrum Punches
- Nasal Cutting Forceps
- Nasal Dressing Forceps
- Nasal Scissors
- Punches
- Sickle Knives
- Sinus Probes
- Sinus Seekers
- Spoon Forceps

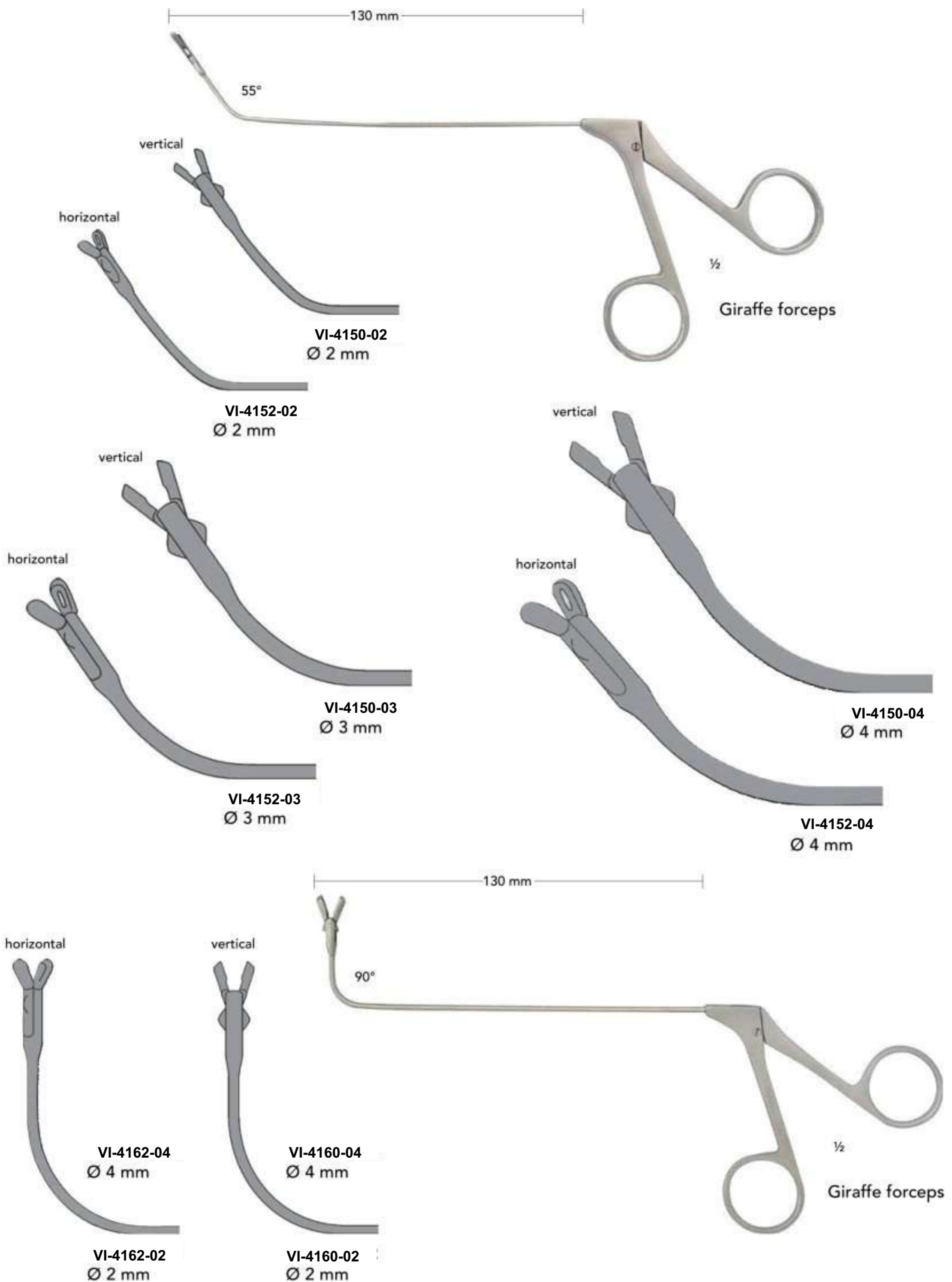

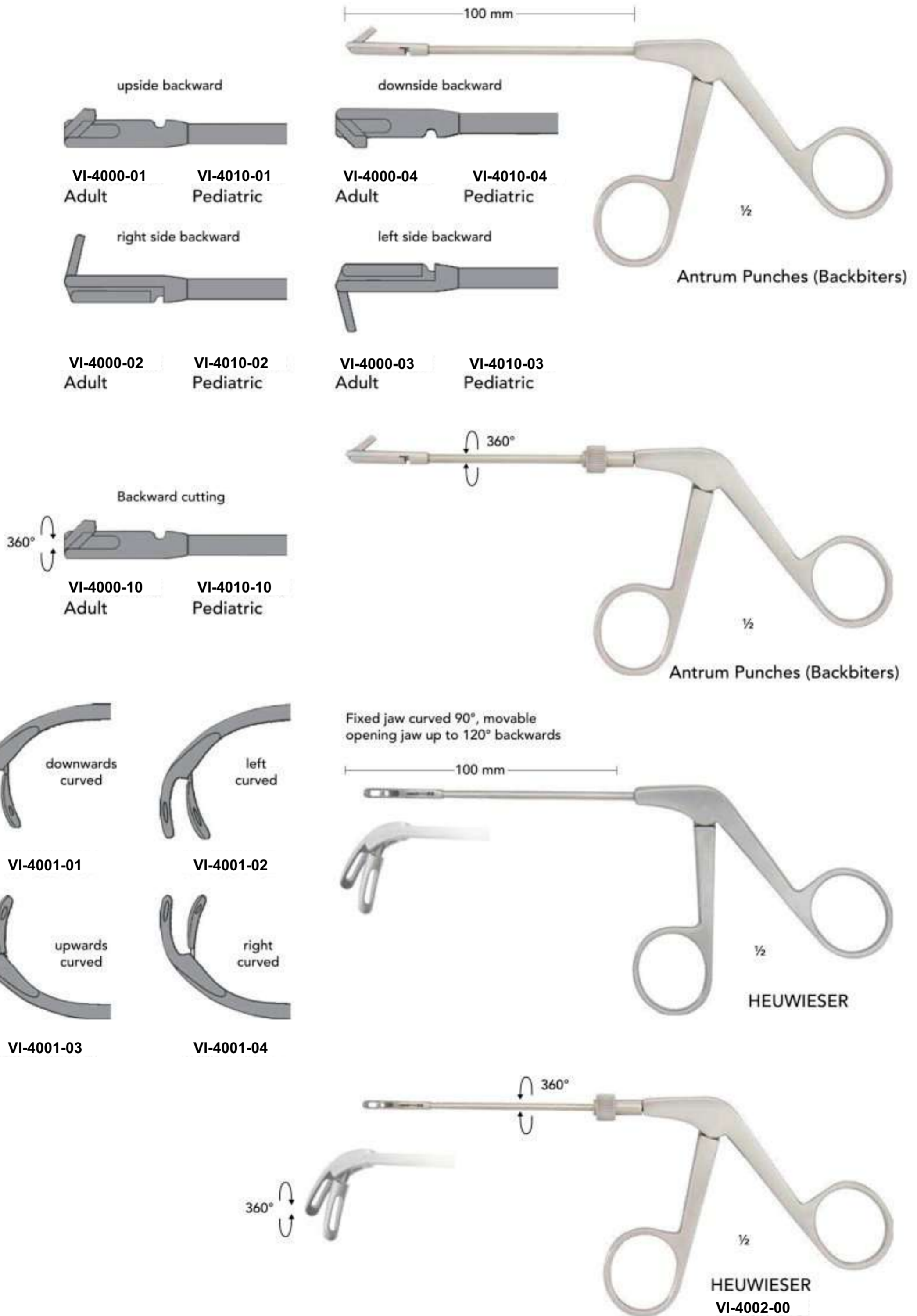

Double Spoon Biopsy Forceps - Oval Shape



VASE INSTRUMENTS
PREMIUM QUALITY INSTRUMENTS

Sinus Surgery

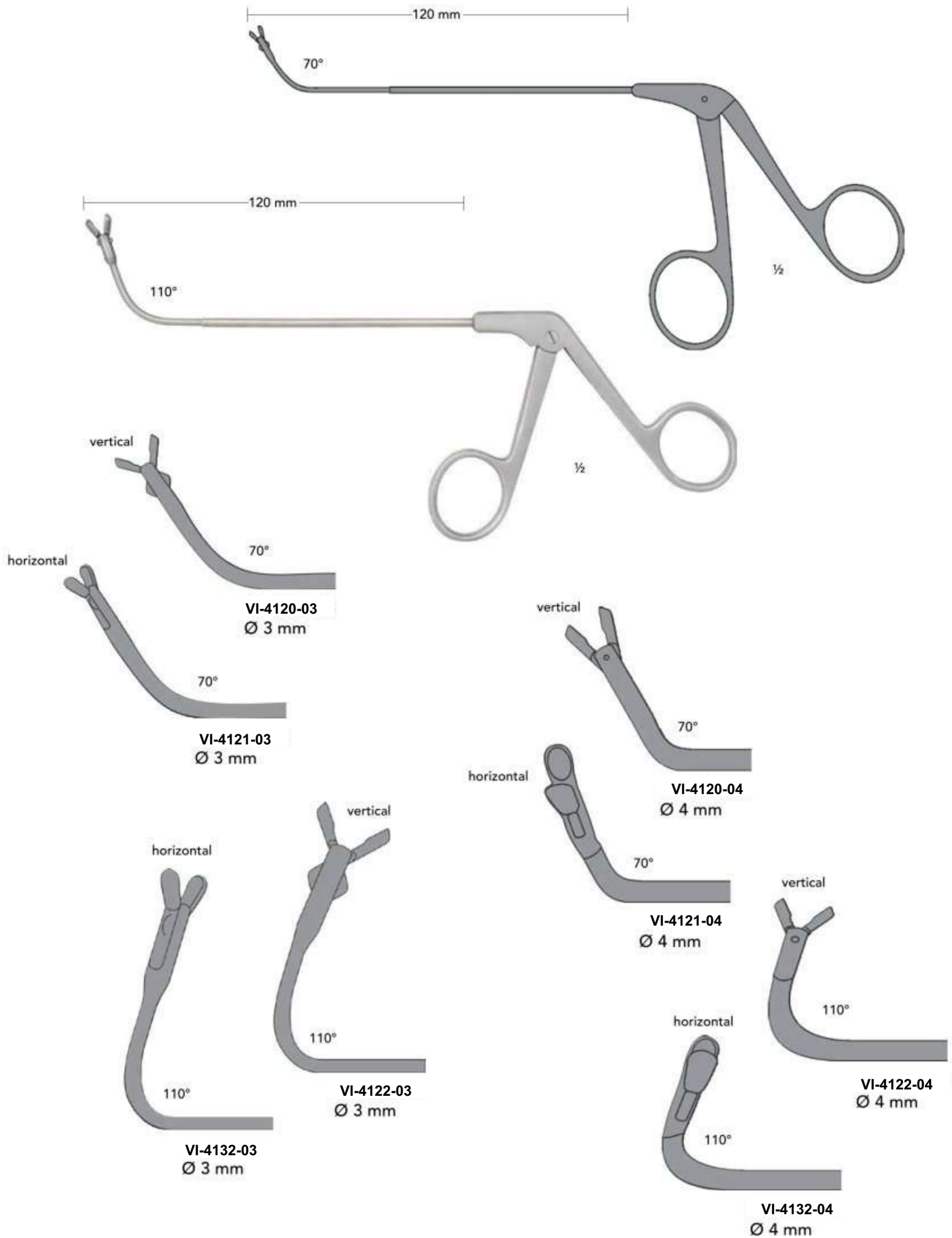

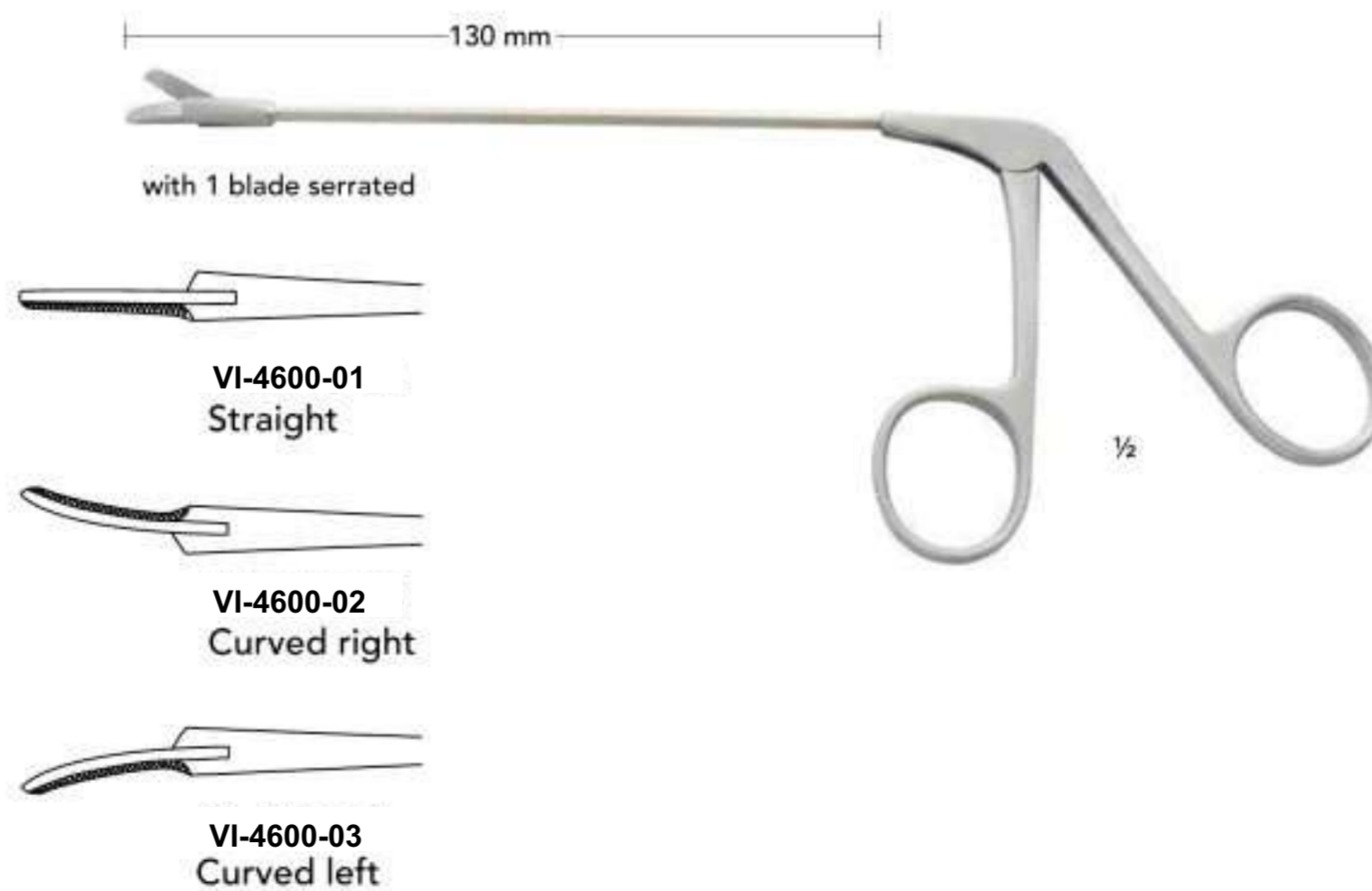
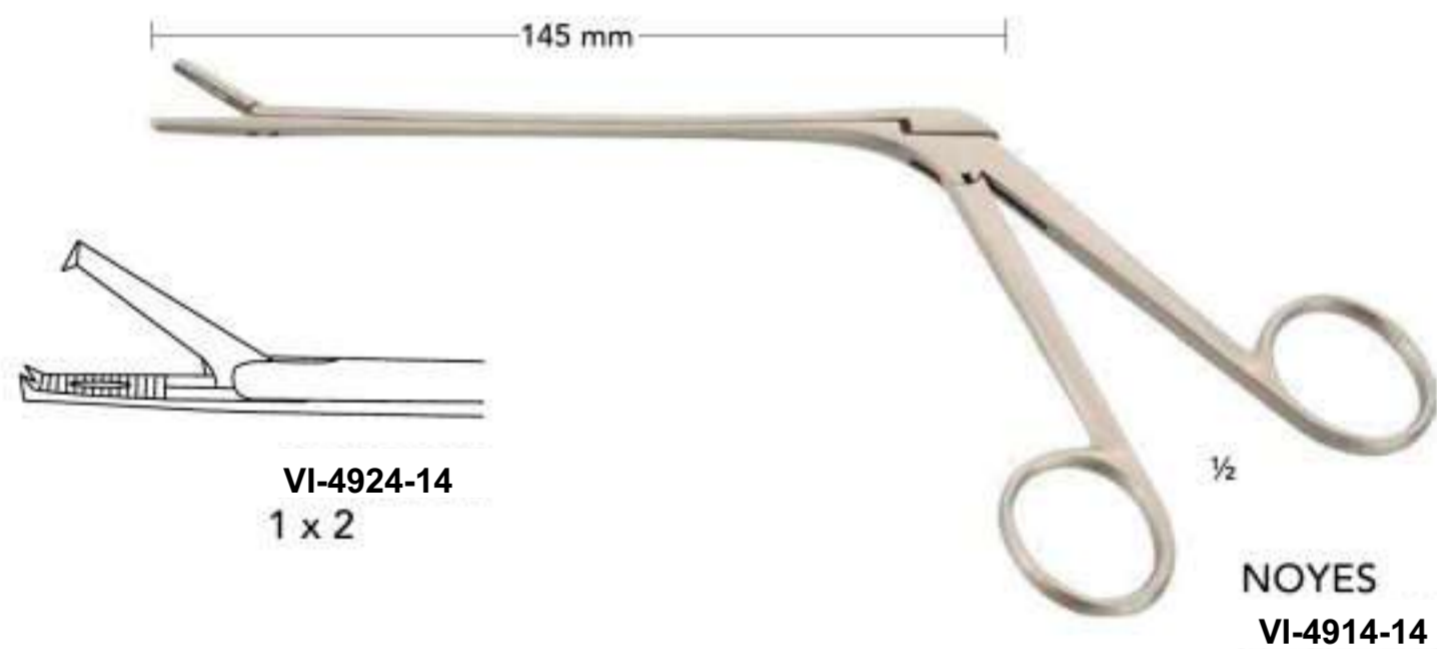
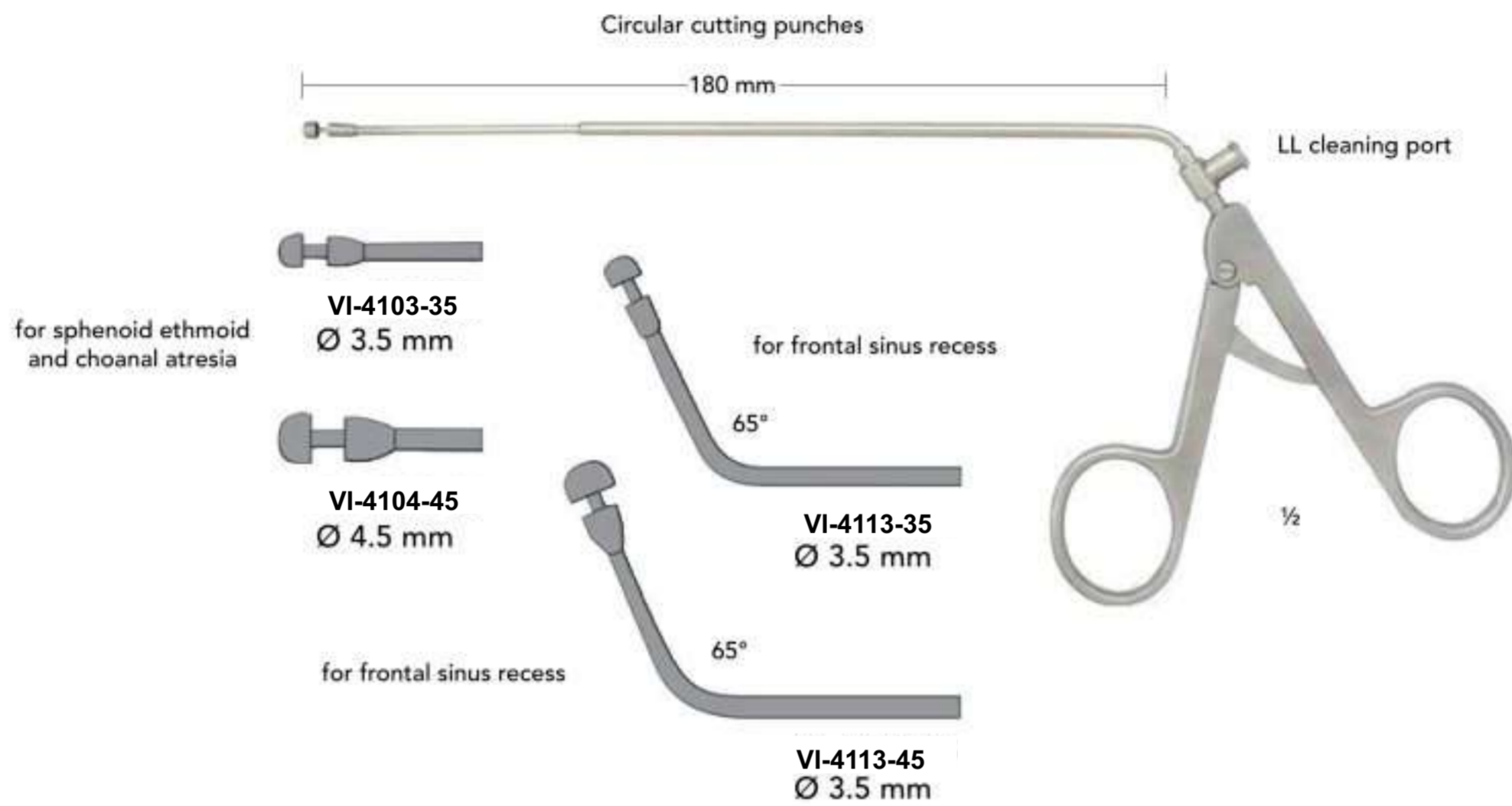



Sinus Surgery

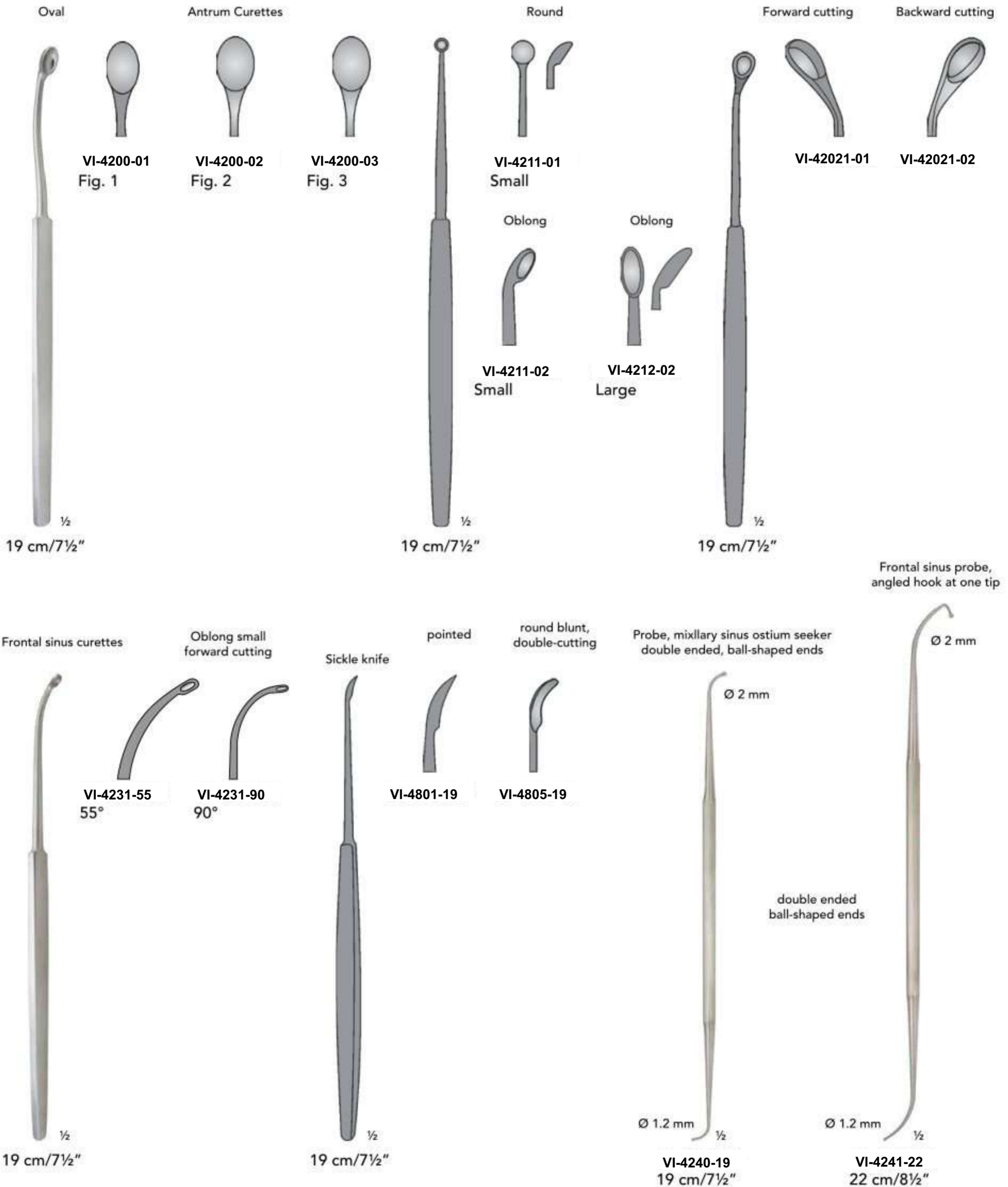



VASE **INSTRUMENTS**
PREMIUM QUALITY INSTRUMENTS

Larynx, Tonsil

- Injection Needles
- Laryngeal Forceps
- Laryngeal Mirrors
- Laryngeal Polypus Forceps
- Retractors
- Tampon Forceps
- Tongue Depressor
- Tonsil Hemostatic Forceps
- Tonsil Knives
- Tonsil Punches
- Tonsil Seizing Forceps
- Tracheal Instruments



Larynx, Tonsil

VI-4001-18 **VI-4003-18** **VI-4011-18** **VI-4013-18**

short long short long

VI-4021-18 **VI-4023-18** **VI-4027-18**

Elevator graduated Elevator

VI-4001-18 **VI-4102-18**

left right

SALYER
18 cm/7"
1/2

VI-4220-22 **VI-4222-23** **VI-4269-25** **VI-4281-22** **VI-4289-23** **VI-4291-23** **VI-4311-22** **VI-4311-03**

FISHER **COLVER** **CARPENTER** **HURD** **HENKE** **LUNIATSCHEK**

22.5 cm/9" 23 cm/9" 25 cm/10" 22.5 cm/9" 24.5 cm/9 3/4" 17.5 cm/7"

ABRAHAM BRUENINGS

VI-4421-22 **VI-4428-23**

22 cm/8 3/4" 23 cm/9"

serrated Tonsil knife Tonsil Dissector Gauze Packers

4.5 mm 11 mm 11.5 mm 16.5 mm 2 mm 3 mm

9 mm 14 mm 5 mm 5 mm 2 mm 3 mm

Tonsil grasping forceps

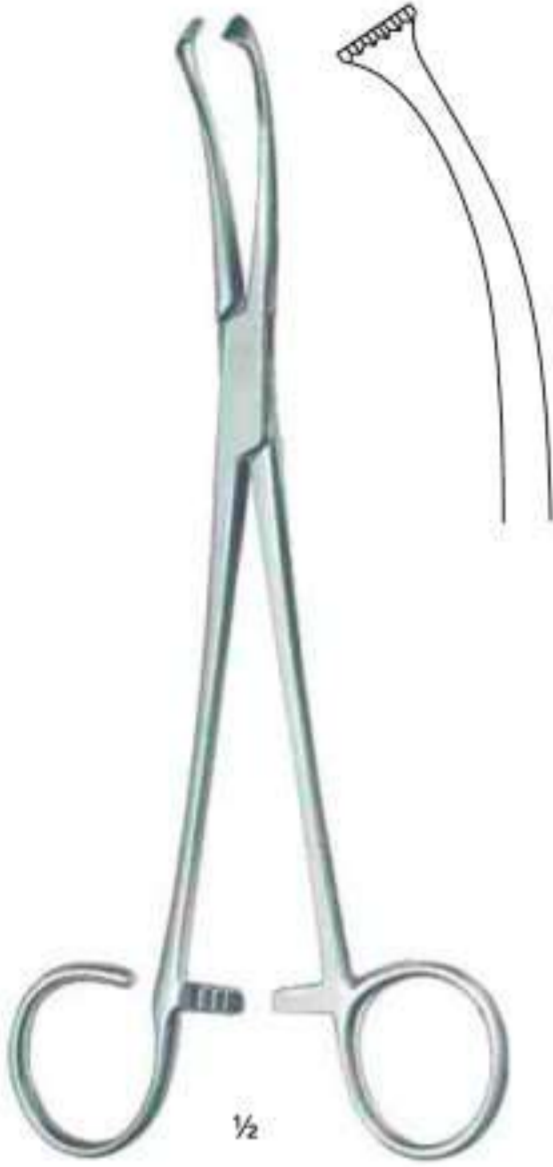

WHITE
VI-4419-18
18 cm/7"



BLOHMKE
VI-4423-20
20 cm/8"

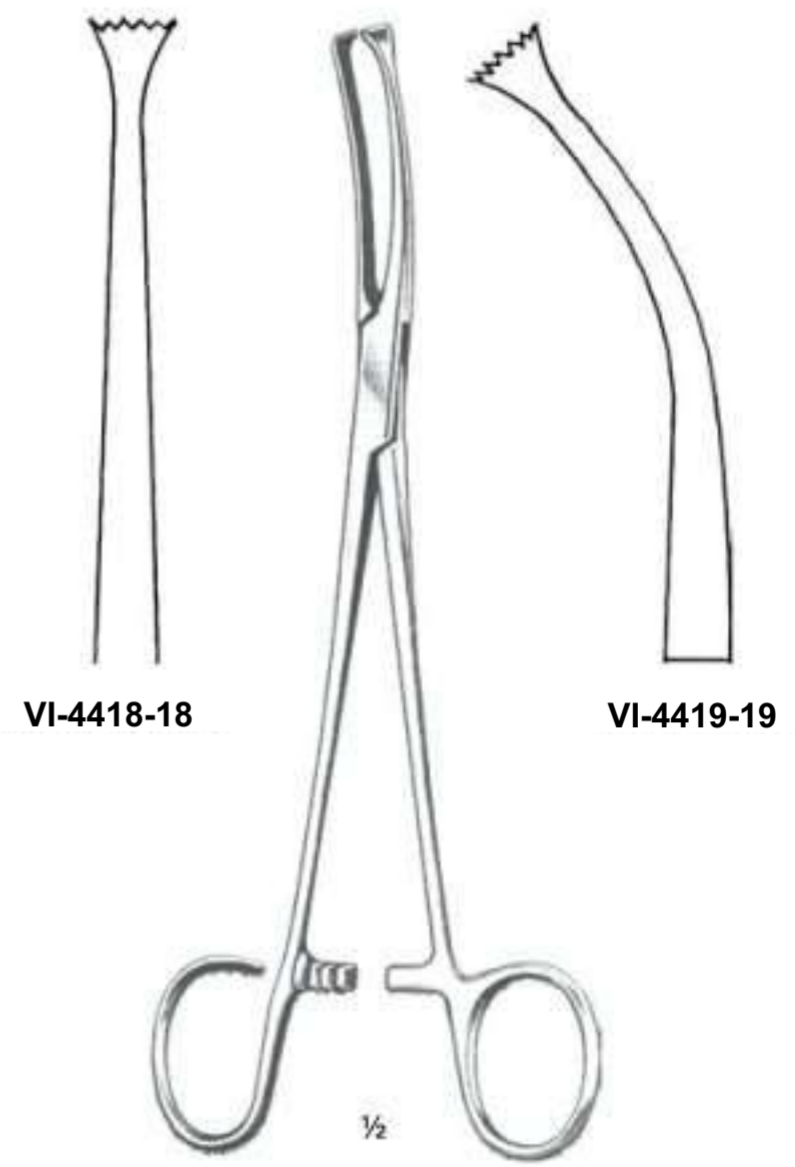

COLVER
19 cm/7½"

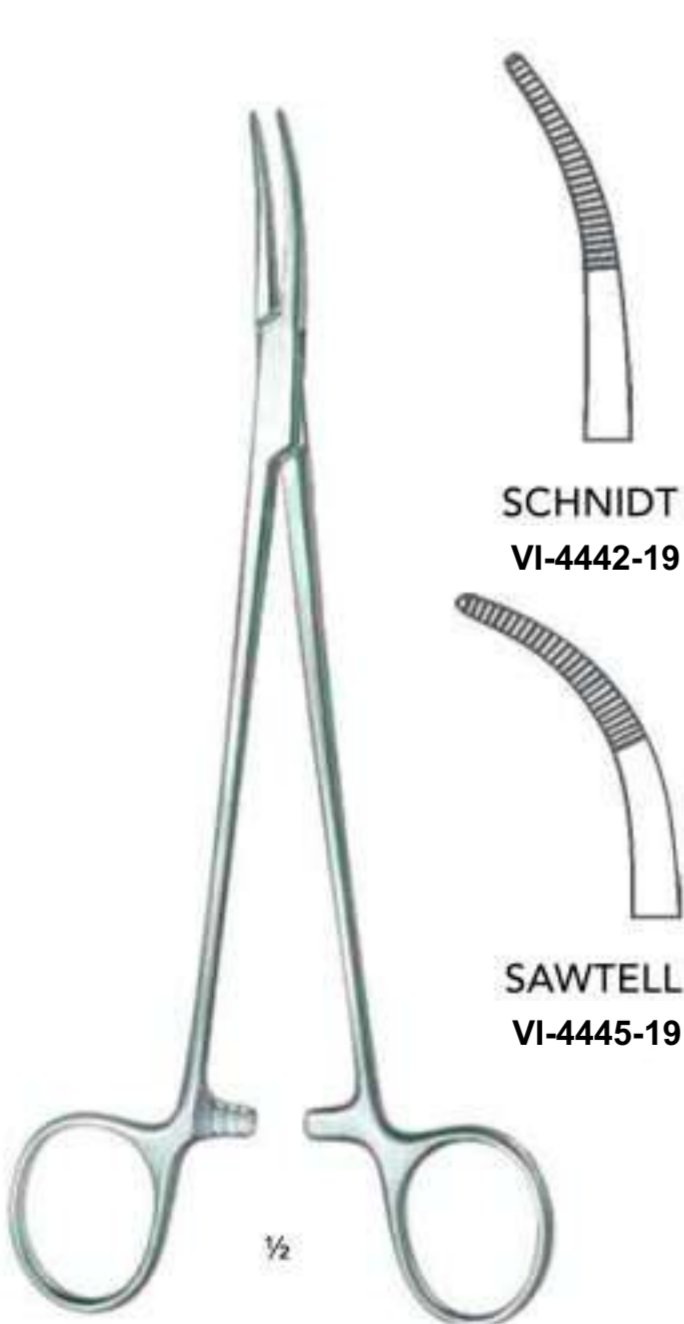

19 cm/7½"



SCHNIDT
VI-4442-19

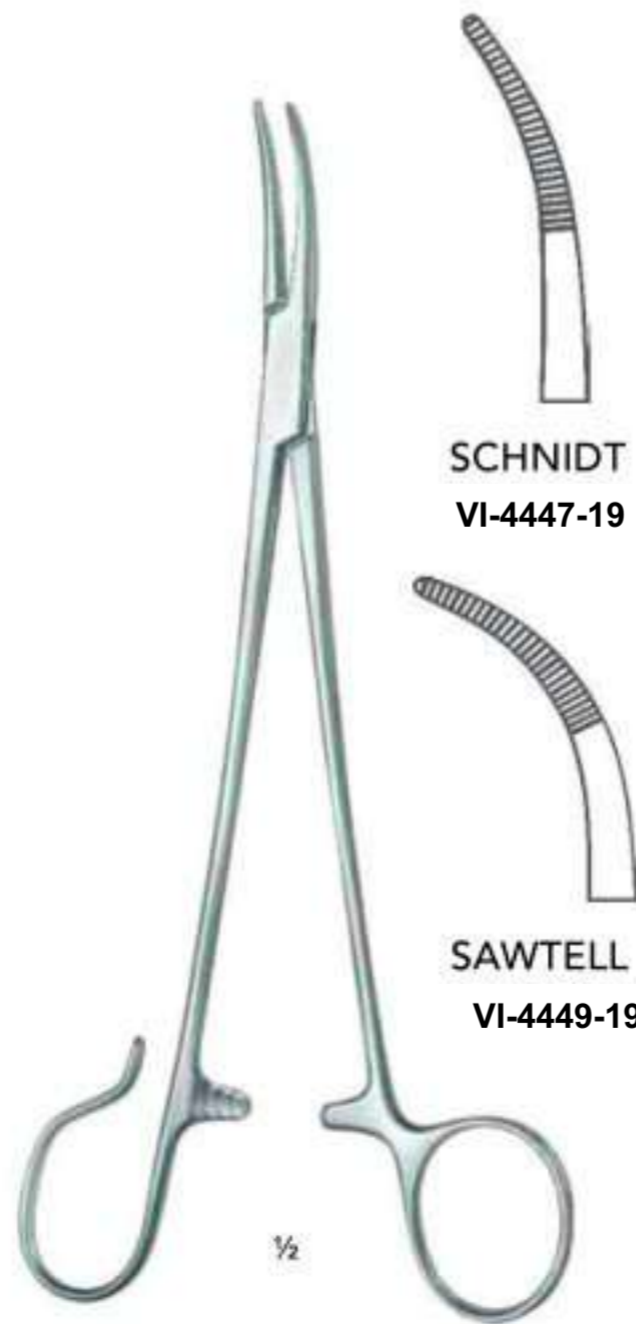

19 cm/7½"



SCHNIDT
VI-4447-19



SAWTELL
VI-4449-19



VI-4422-22
Fig. 1



VI-4423-33
Fig. 2



TIVNEN-TYDINGS
21 cm/8¼"

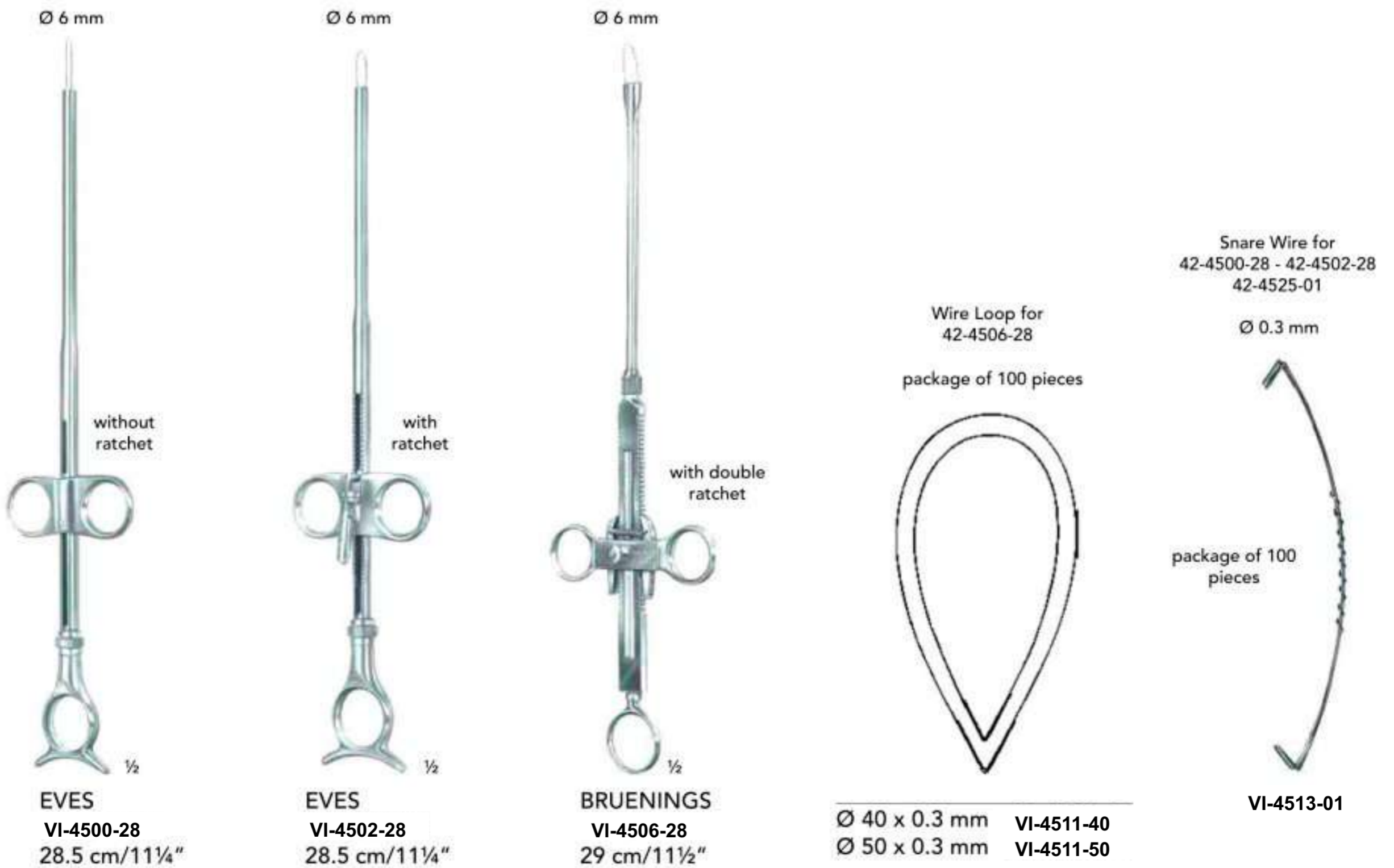
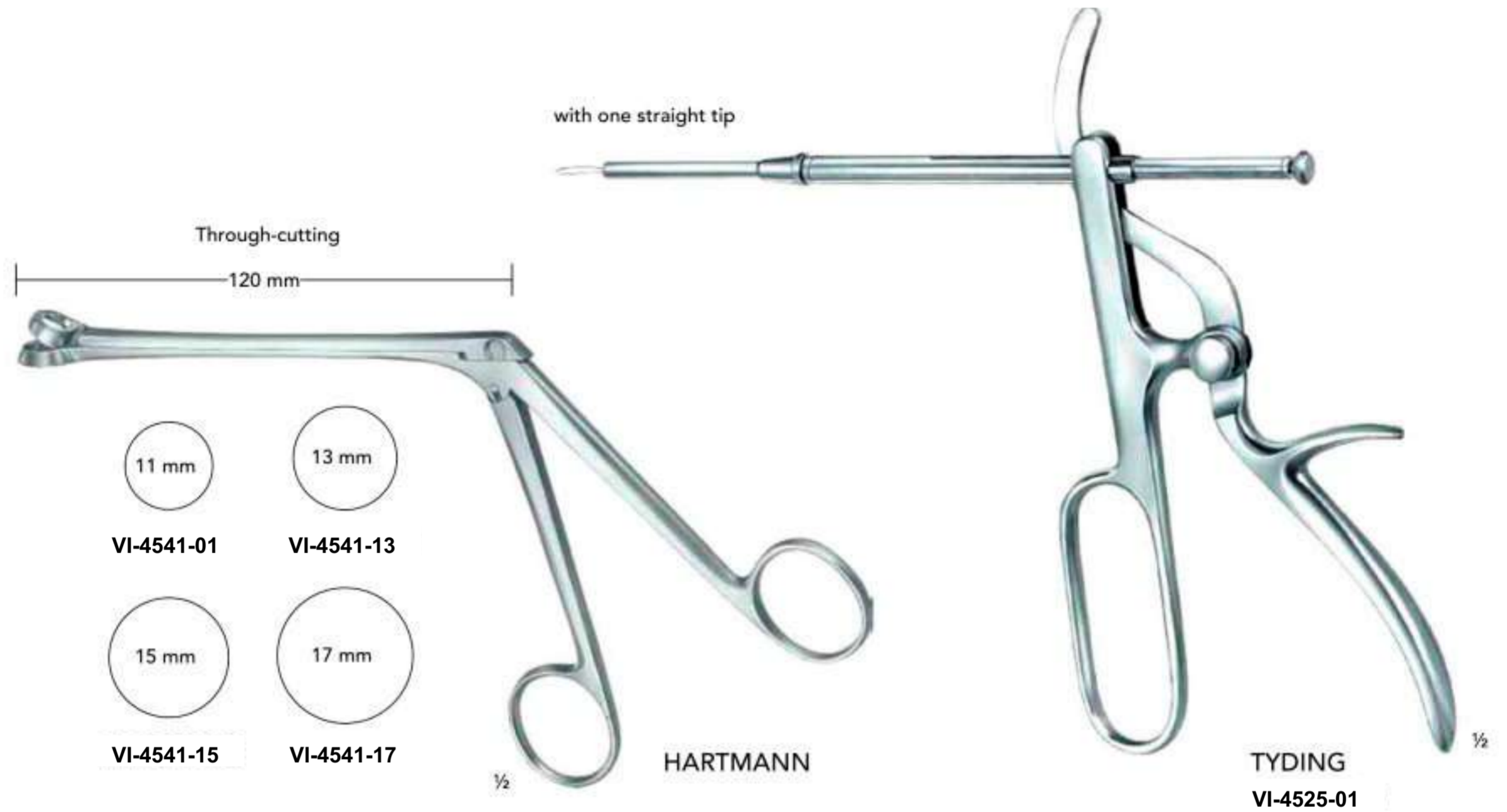



BRUENINGS
 22 cm/8³/₄" VI-584-20
 32 cm/12³/₄" VI-584-30
 41 cm/16¹/₄" VI-584-40



BRUENINGS
 VI-9587-20
 18 cm/7"



HUBER
 VI-9581-01



FRAENKEL
 VI-9600-01



SEIFFERT
 VI-9604-01



FRAENKEL
 VI-9608-01



SCHEINMANN
 VI-9611-01



SCHEINMANN
 VI-9613-01



BRUENINGS
 Fig. 2 VI-9616-02
 Fig. 3 VI-9616-03



BRUENINGS
 Fig. 2 VI-9618-02
 Fig. 3 VI-9618-03



LANGE
 VI-9624-01

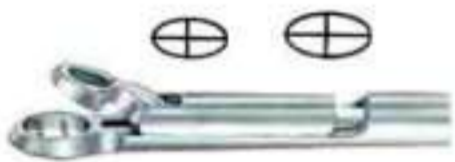

KRAUSE
 Fig. 1 VI-9628-01
 Fig. 2 VI-9628-02



KRAUSE
 VI-9632-01

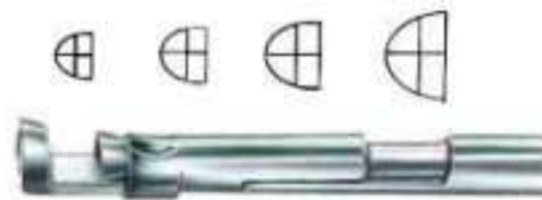

CORDES
 Fig. 1 VI-9637-01
 Fig. 2 VI-9637-02
 Fig. 3 VI-9637-03
 Fig. 4 VI-9637-04



SCHUMACHER
 VI-9639-01



CORDES
 Fig. 1 VI-9643-01
 Fig. 2 VI-9643-02



CORDES
 VI-9647-01



ROSENBERG
 VI-9657-01

Larynx, Tonsil

Plane, with fixed handle



18.5 cm/7¼"



Fig. 00	Ø 8 mm	VI-4781-08
Fig. 0	Ø 10 mm	VI-4781-10
Fig. 1	Ø 12 mm	VI-4781-12
Fig. 2	Ø 14 mm	VI-4781-14
Fig. 3	Ø 16 mm	VI-4781-16
Fig. 4	Ø 18 mm	VI-4781-18
Fig. 5	Ø 20 mm	VI-4781-20
Fig. 6	Ø 22 mm	VI-4781-22
Fig. 7	Ø 24 mm	VI-4781-24
Fig. 8	Ø 26 mm	VI-4781-26
Fig. 9	Ø 28 mm	VI-4781-28
Fig. 10	Ø 30 mm	VI-4781-30

Moveable mirror

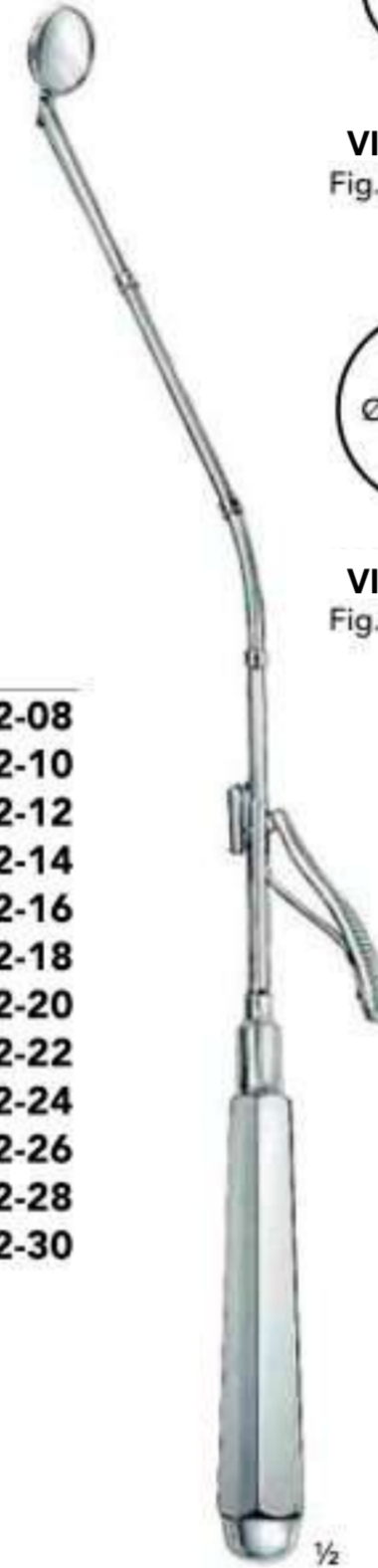

MICHEL
27 cm/7½"



VI-4789-12
Fig. 1

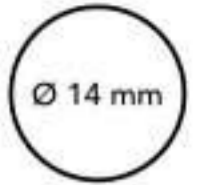

VI-4789-14
Fig. 2

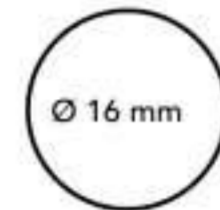

VI-4789-16
Fig. 3

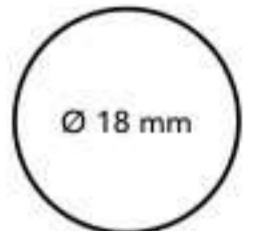

VI-4789-18
Fig. 4

Rhodium front coated

Fig. 00	Ø 8 mm	VI-4782-08
Fig. 0	Ø 10 mm	VI-4782-10
Fig. 1	Ø 12 mm	VI-4782-12
Fig. 2	Ø 14 mm	VI-4782-14
Fig. 3	Ø 16 mm	VI-4782-16
Fig. 4	Ø 18 mm	VI-4782-18
Fig. 5	Ø 20 mm	VI-4782-20
Fig. 6	Ø 22 mm	VI-4782-22
Fig. 7	Ø 24 mm	VI-4782-24
Fig. 8	Ø 26 mm	VI-4782-26
Fig. 9	Ø 28 mm	VI-4782-28
Fig. 10	Ø 30 mm	VI-4782-30

Plane, without handle



13.5 cm/5¼"



Fig. 00	Ø 8 mm	VI-4785-08
Fig. 0	Ø 10 mm	VI-4785-10
Fig. 1	Ø 12 mm	VI-4785-12
Fig. 2	Ø 14 mm	VI-4785-14
Fig. 3	Ø 16 mm	VI-4785-16
Fig. 4	Ø 18 mm	VI-4785-18
Fig. 5	Ø 20 mm	VI-4785-20
Fig. 6	Ø 22 mm	VI-4785-22
Fig. 7	Ø 24 mm	VI-4785-24
Fig. 8	Ø 26 mm	VI-4785-26
Fig. 9	Ø 28 mm	VI-4785-28
Fig. 10	Ø 30 mm	VI-4785-30

Rhodium front coated

Fig. 00	Ø 8 mm	VI-4786-08
Fig. 0	Ø 10 mm	VI-4786-10
Fig. 1	Ø 12 mm	VI-4786-12
Fig. 2	Ø 14 mm	VI-4786-14
Fig. 3	Ø 16 mm	VI-4786-16
Fig. 4	Ø 18 mm	VI-4786-18
Fig. 5	Ø 20 mm	VI-4786-20
Fig. 6	Ø 22 mm	VI-4786-22
Fig. 7	Ø 24 mm	VI-4786-24
Fig. 8	Ø 26 mm	VI-4786-26
Fig. 9	Ø 28 mm	VI-4786-28
Fig. 10	Ø 30 mm	VI-4786-30



VI-4794-11
11 cm/4¼"



VI-4798-12
12.5 cm/5"



FRAENKEL
VI-4519-18
18 cm/7"

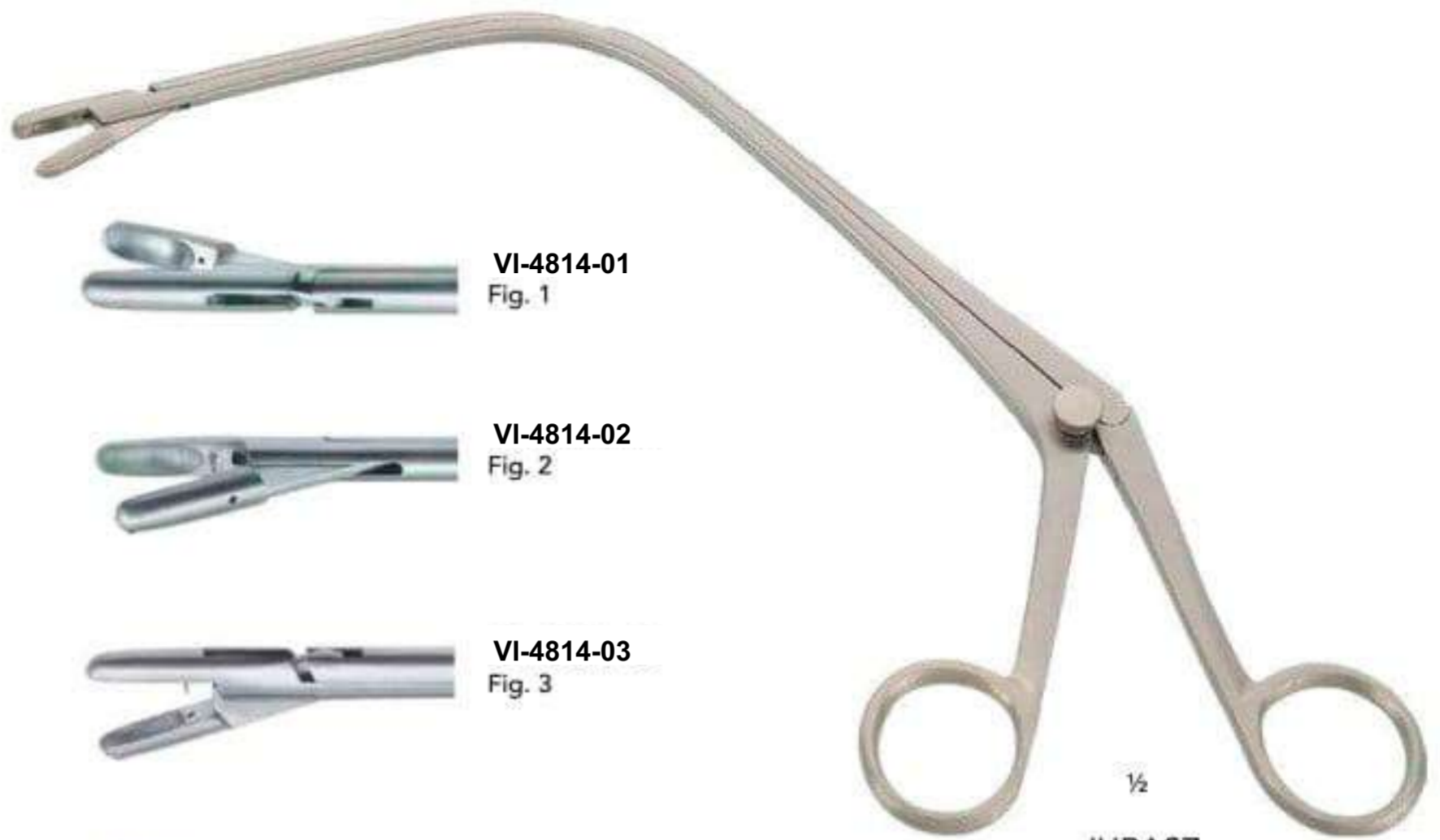

$\frac{1}{2}$
JURASZ
23 cm/9"



VI-4814-01
Fig. 1



VI-4814-02
Fig. 2



VI-4814-03
Fig. 3



VI-4814-04
Fig. 4

13.5 mm



NAGER
VI-4624-19
19 cm/17½"

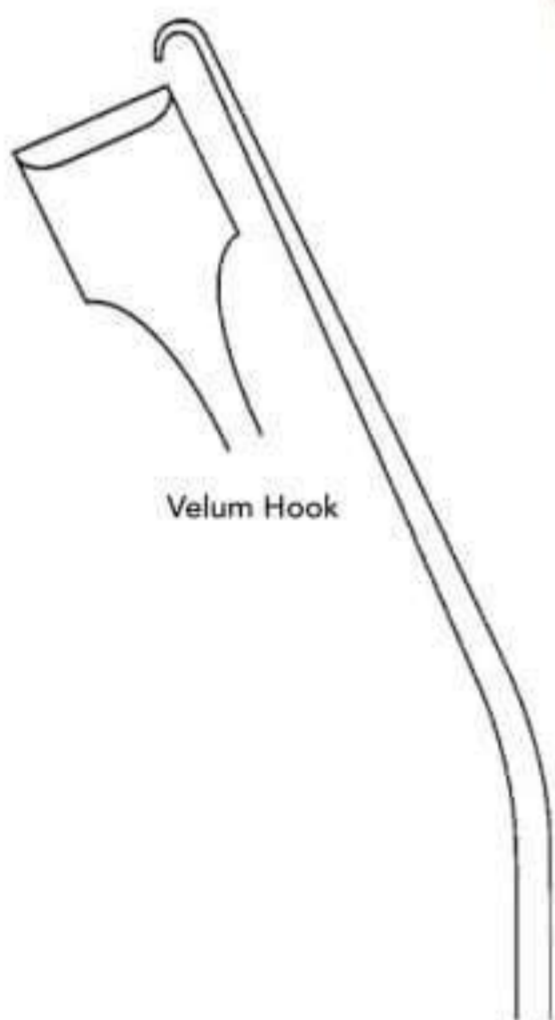

Velum Hook



Arch palate hook

HOFER
VI-4644-24
24 cm/9½"



REICHERT
VI-4624-24
24 cm/9½"

3 mm



JACKSON
VI-4022-22
22 cm/8¾"

3 mm



VI-4122-22



Larynx, Tonsil

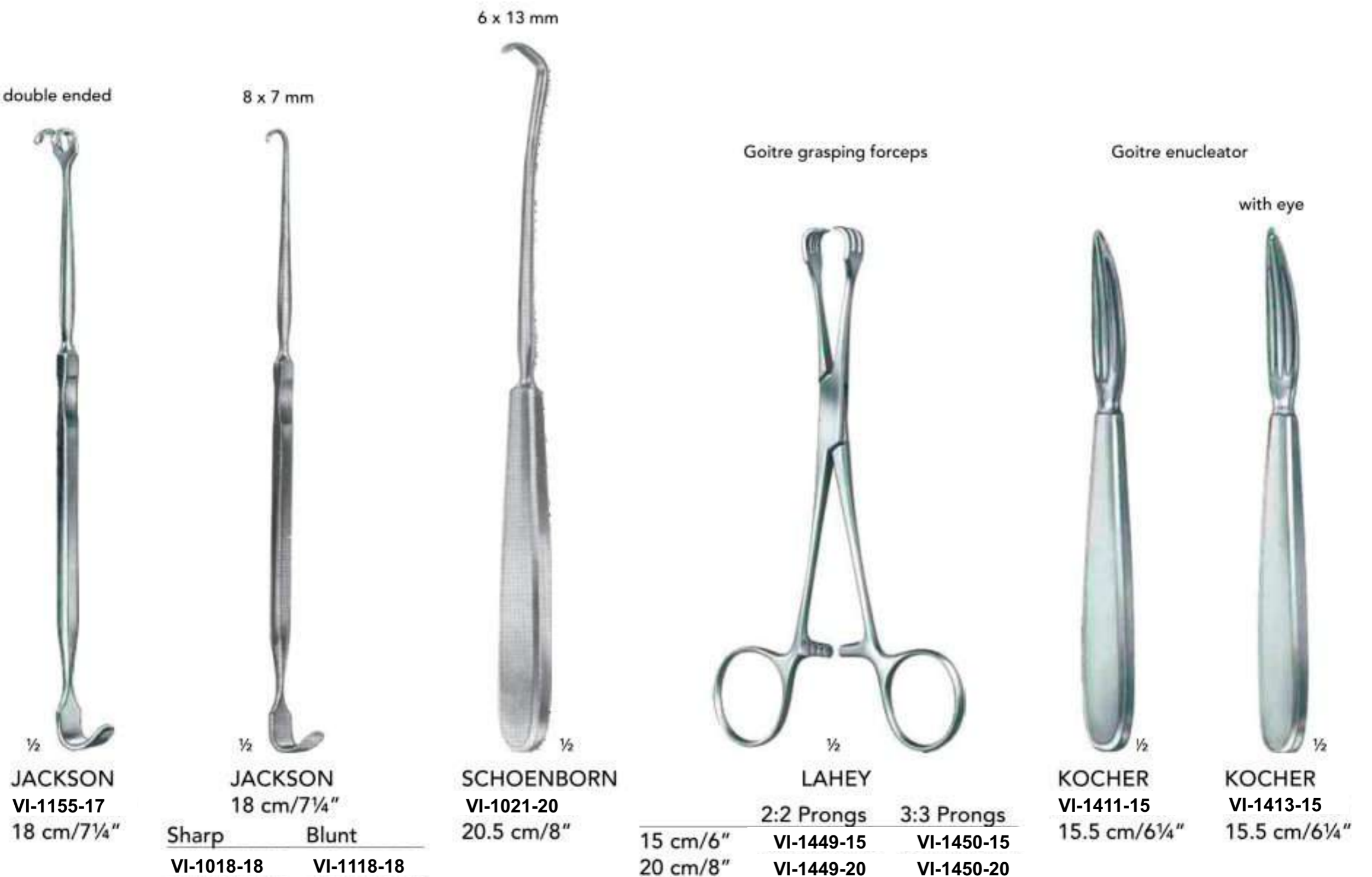
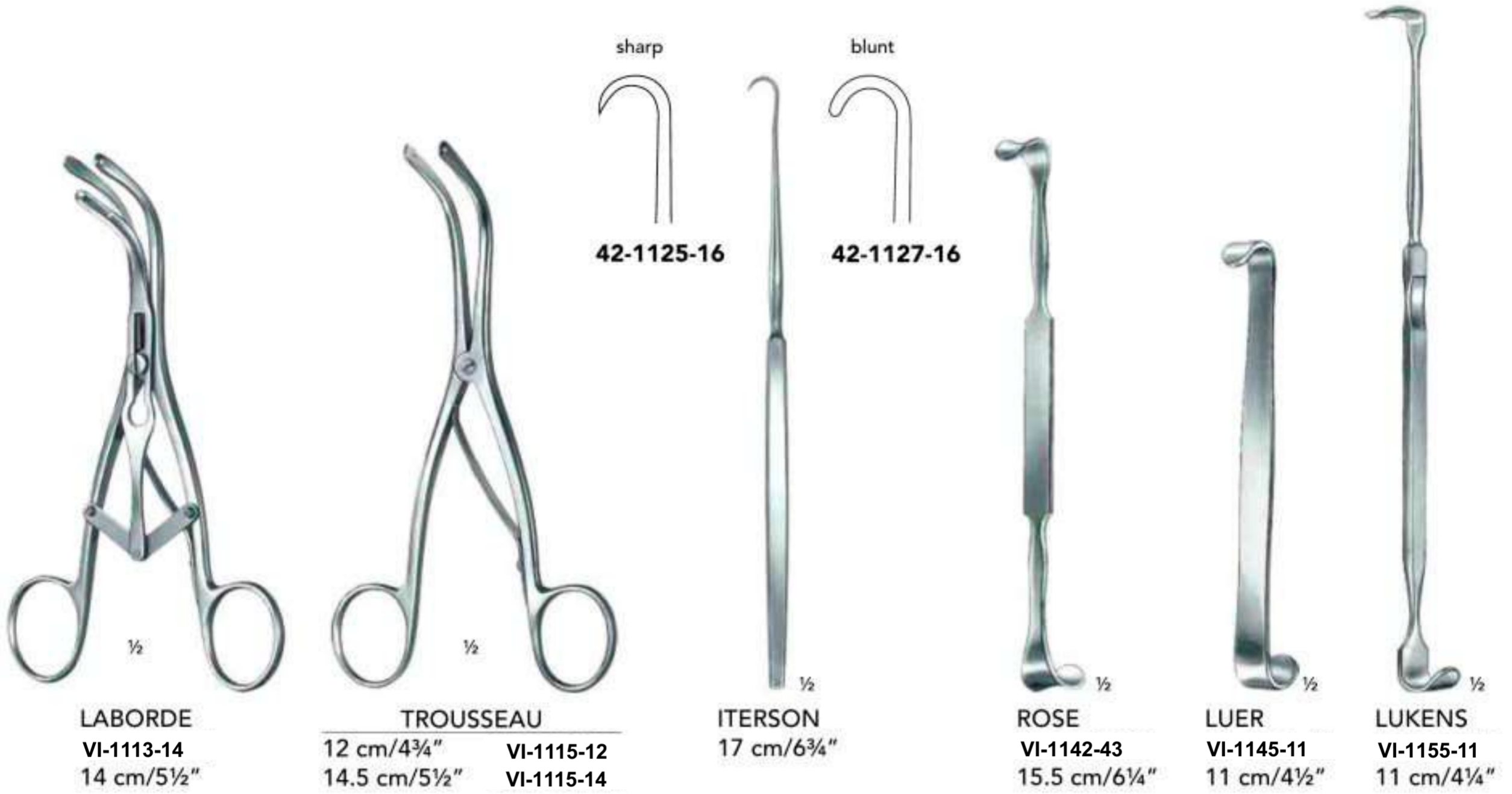



VASE **INSTRUMENTS**
PREMIUM QUALITY INSTRUMENTS

Microlaryngology

- Chest Supports
- Cotton Carriers
- Injection Cannulas
- Light Guide Carriers
- Microlaryngology Forceps
- Microlaryngology Instruments
- Microlaryngology Needle Holders
- Microlaryngology Scissors
- Operating Laryngoscopes
- Suction Tubes
- Teeth Protectors

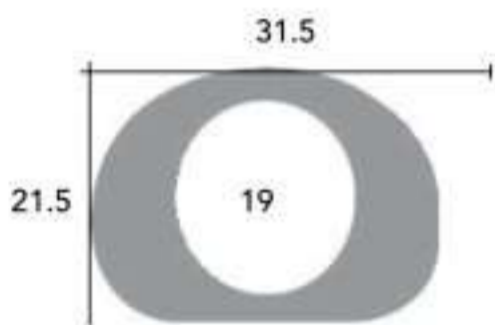
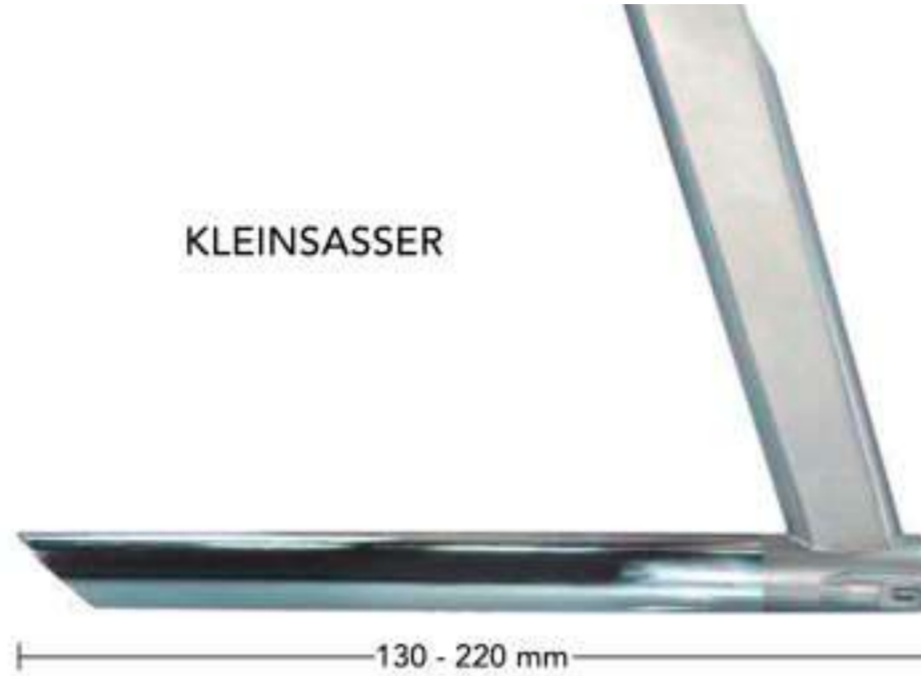

VI-8201-17
17 cm/6¾"
Adult X - Large

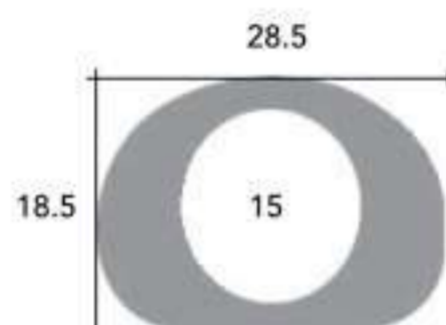

VI-8202-17
17 cm/6¾"
Adult Large

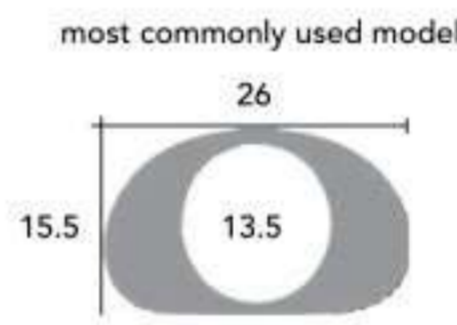

most commonly used model
VI-8203-17
17 cm/6¾"
Adult Medium

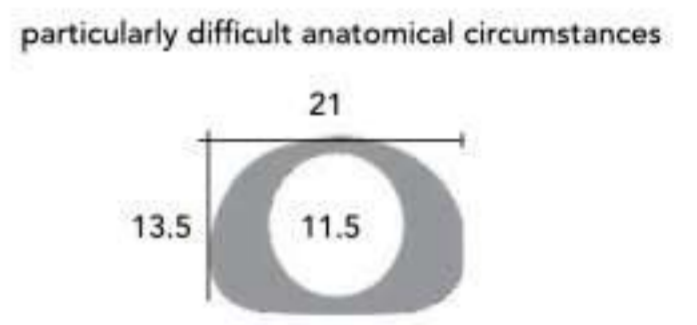

particularly difficult anatomical circumstances
VI-8204-17
18 cm/7"
Adult Small

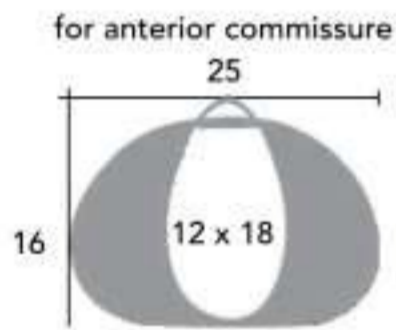

for anterior commissure
VI-8205-18
18 cm/7"
Adult Medium

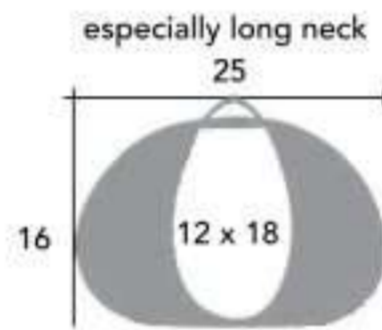

especially long neck
VI-8206-22
22 cm/8¾"
Adult Medium

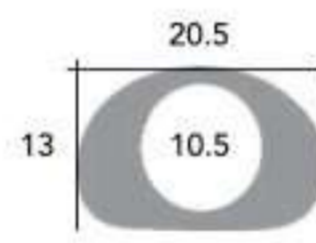

VI-8207-15
15 cm/6"
Children Small

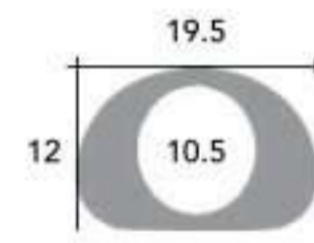

VI-8208-13
13 cm/5"
Infant Small

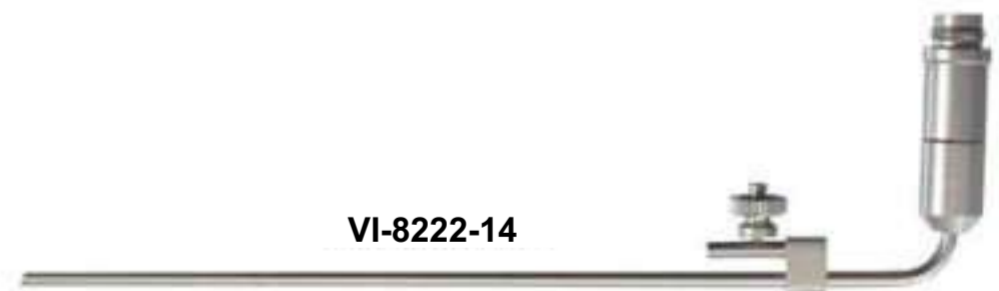

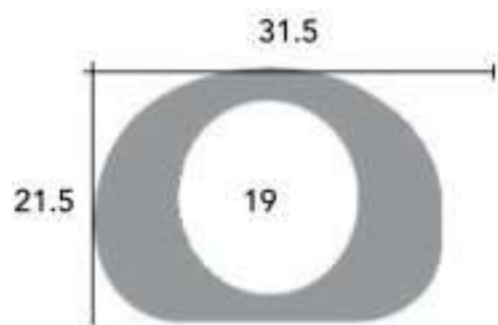

VI-8211-17
17 cm/6¾"
Adult X - Large

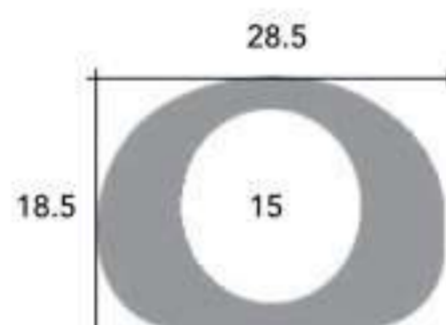

VI-8212-17
17 cm/6¾"
Adult Large

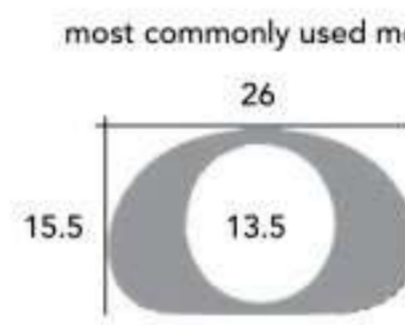

most commonly used model
VI-8213-17
17 cm/6¾"
Adult Medium

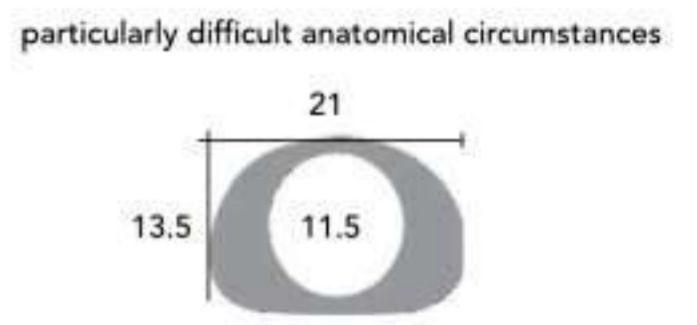

particularly difficult anatomical circumstances
VI-8214-18
18 cm/7"
Adult Small

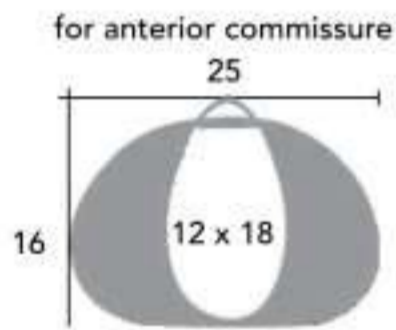

for anterior commissure
VI-8215-18
18 cm/7"
Adult Medium

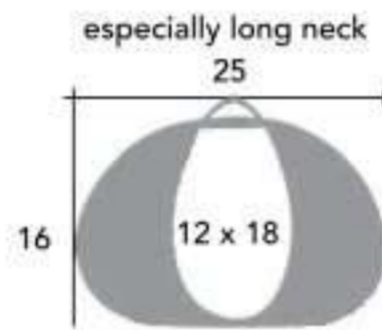

especially long neck
VI-8216-22
22 cm/8¾"
Adult Medium

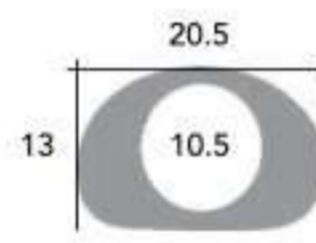

VI-8217-15
15 cm/6"
Children Small

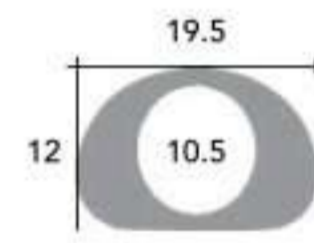

VI-8218-13
13 cm/5"
Infant Small



VI-8222-14



VI-8232-12

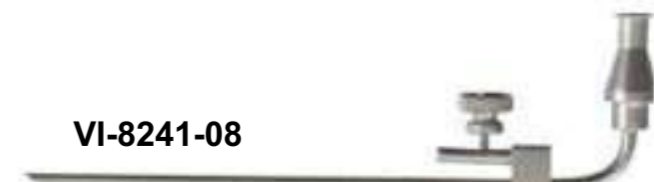

VI-8241-08

KLEINSASSER Chest Support

With adjustment wheel, Ring Diameter Ø 9.5 mm

	Working length	for
VI-8110-24	24 cm/9½"	Children
VI-8120-34	34 cm/13½"	Adults



with adjustment wheel

Support Rod Only, With ring

	Working length	for
VI-8115-24	24 cm/9½"	Children
VI-8125-24	34 cm/13½"	Adults



Holder Only

	for
VI-8115-99	Chest Support





HOLINGER Operating Laryngoscope
Complete with light guide

	Use for	Handles	Working Length
VI-8551-12	Babies	Small	12.5 cm/5"
VI-8551-17	Children	Small	17 cm/6¾"
VI-8551-18	Adult	Large	18 cm/7"



JACKSON Operating Laryngoscope
Complete with light guide

	Use for	Handles	Working Length
VI-8561-12	Babies	Small	12.5 cm/5"
VI-8561-17	Children	Small	17 cm/6¾"
VI-8561-18	Adult	Large	18 cm/7"



Microsurgery Forceps - Finger Movable

	Ø 2 mm	Grasping Forceps	
	VI-8621-02	Straight	
	VI-8622-02	Upwards	
	VI-8623-02	Curved right	
	VI-8624-02	Curved left	
	Ø 2 mm	Scissors	
	VI-8631-02	Straight	
	VI-8632-02	Upwards 45°	
	VI-8633-02	Curved right	
	VI-8634-02	Curved left	
	VI-8635-02	Curved horizontal	
Ø 4 mm	Ø 2 mm	Cup Shaped Forceps	
VI-8601-04	VI-8601-02	Straight	
VI-8602-04	VI-8602-02	Upwards	
VI-8603-04	VI-8603-02	Curved right	
VI-8604-04	VI-8604-02	Curved left	

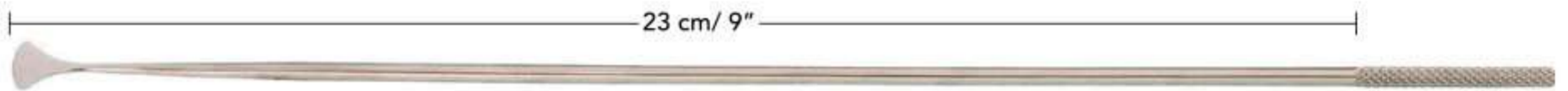

VI-8251-01	knife, oval, straight	
VI-8251-02	knife, oval, 45°	
VI-8251-03	sickel knife, curved	
VI-8251-04	sickel knife, straight	
VI-8251-05	knife, golf stick shaped	
VI-8251-06	knife, round, vertical cutting	
VI-8251-07	hook, blunt	
VI-8251-08	hook, sharp	
VI-8251-09	hook, with probe end 90°	
VI-8251-10	needle, curved to right	
VI-8251-11	needle, curved to left	
VI-8251-12	elevator, with suction channel	
VI-8251-13.	knot pusher / tier	

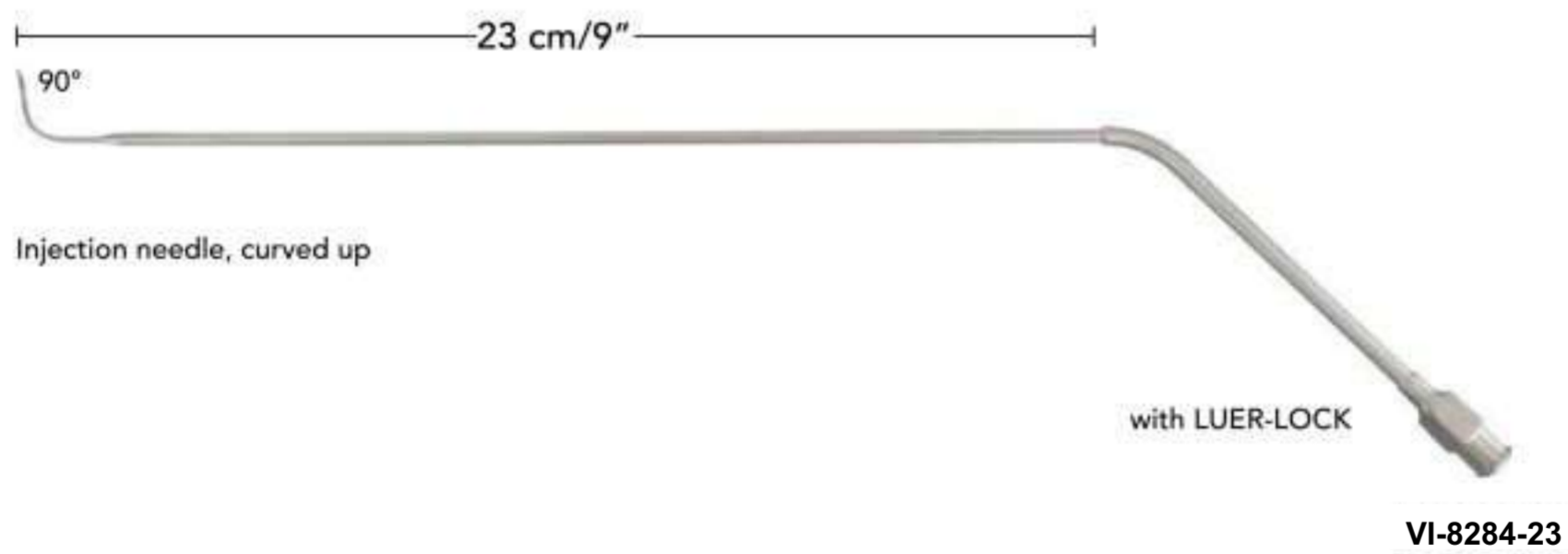
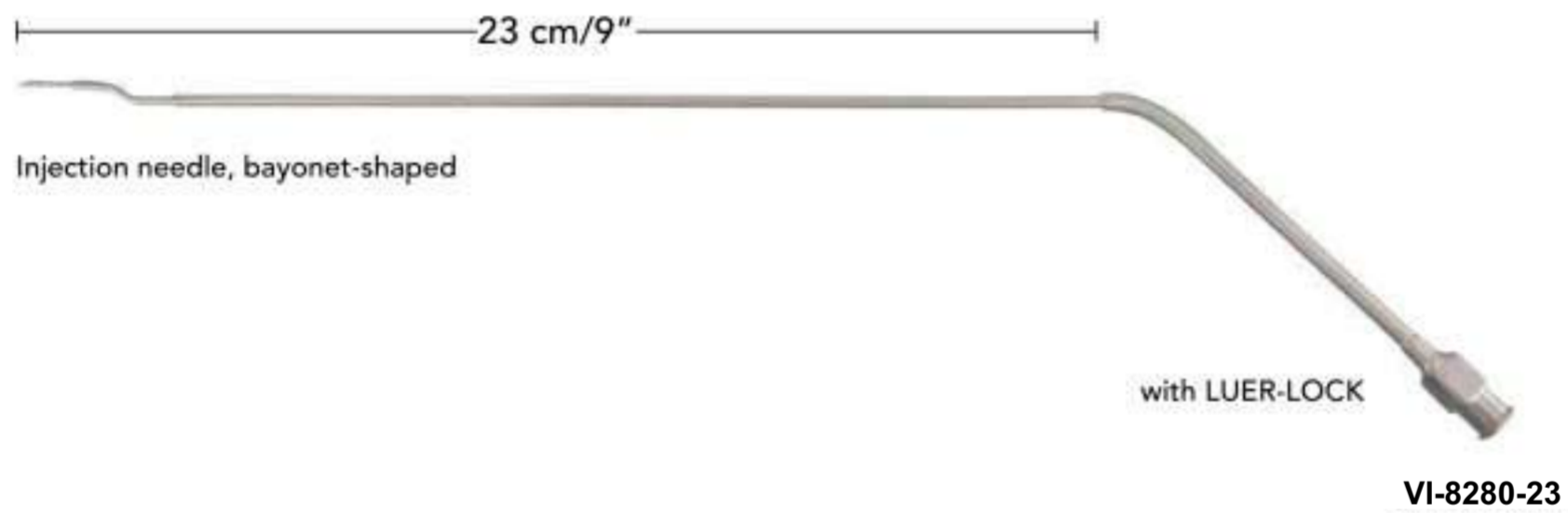
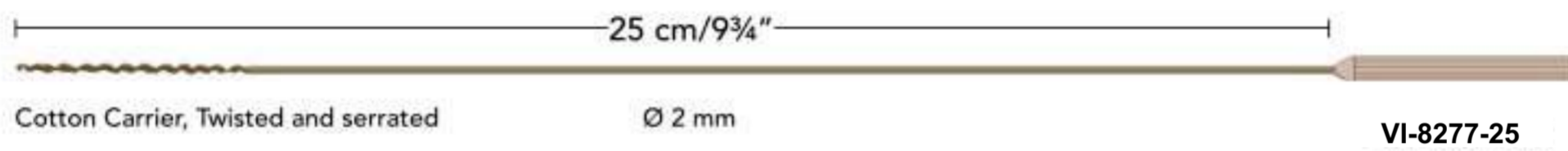
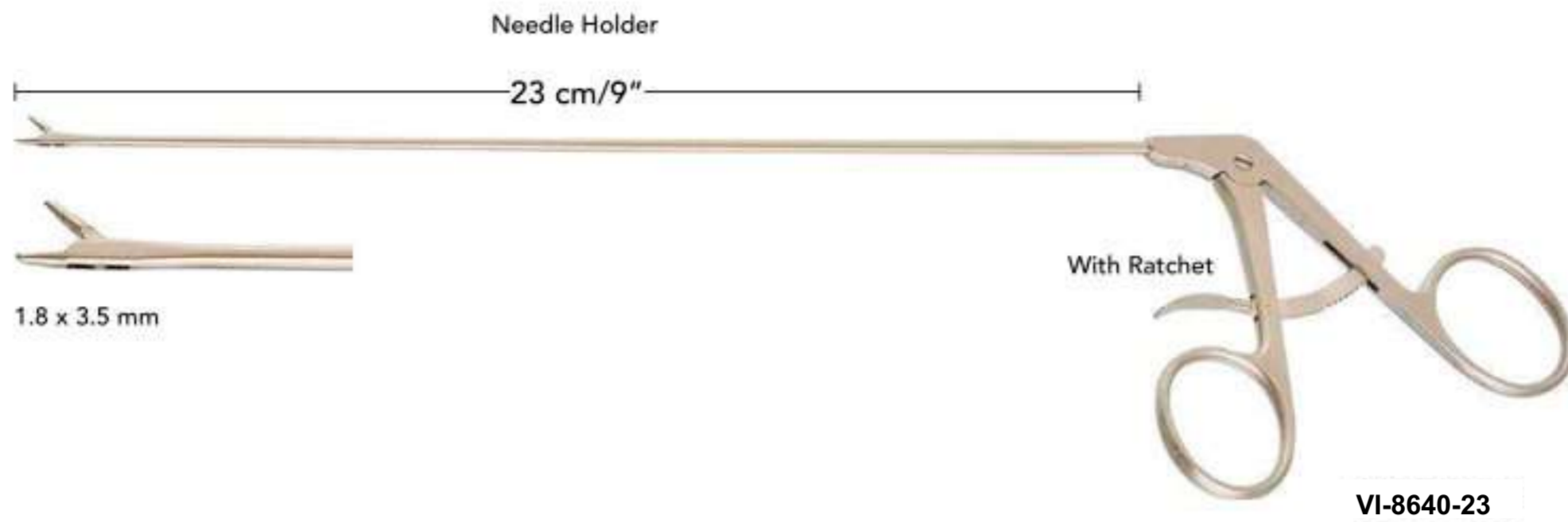



VASE **INSTRUMENTS**
PREMIUM QUALITY INSTRUMENTS

Oral & Maxilo Facial

- Bone Contouring Forceps
- Cheek Retractor
- Chest Support
- Extra Oral Retractors
- Intra Oral Retractors
- Lip & Cheek Vestibulum Retractors
- Mandibular Retractors
- Mouthgags
- Multi Purpose Retractors
- Osteotomes
- Periosteal Elevators
- Ramus Retractors
- Soft Tissue Retractors



VI-4224-04
Fram only



VI-4224-01
Fig. 1

VI-4224-02
Fig. 2

VI-4224-03
Fig. 3

DINGMANN
VI-4224-00
Complete Set



VI-4222-01
Fig. 1

VI-4222-02
Fig. 2

VI-4222-03
Fig. 3



McIVOR
VI-4222-00
Complete set

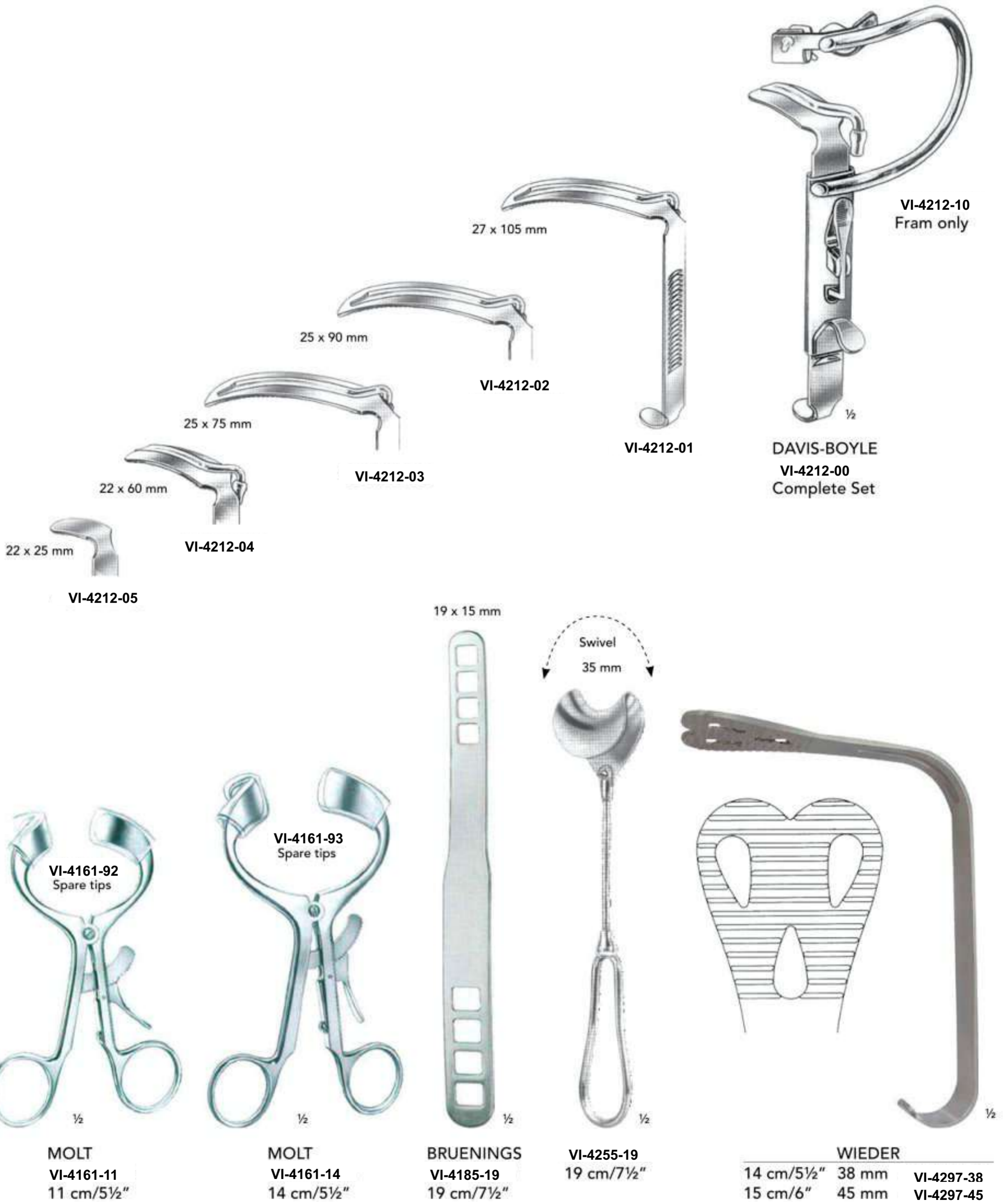

27 x 105 mm

VI-4212-10
Fram only

25 x 90 mm

VI-4212-02

VI-4212-01

DAVIS-BOYLE
VI-4212-00
Complete Set

25 x 75 mm

VI-4212-03

22 x 60 mm

VI-4212-04

22 x 25 mm

VI-4212-05

19 x 15 mm

Swivel
35 mm

VI-4161-92
Spare tips

VI-4161-93
Spare tips

BRUENINGS
VI-4185-19
19 cm/7½"

VI-4255-19
19 cm/7½"

WIEDER

14 cm/5½"	38 mm	VI-4297-38
15 cm/6"	45 mm	VI-4297-45

MOLT
VI-4161-11
11 cm/5½"

MOLT
VI-4161-14
14 cm/5½"

Beveled edge



OBWEGESER
18 cm/7"



VI-1130-06
6 mm



VI-1130-09
9 mm



VI-1130-07
7 mm



VI-1130-11
11 mm

Flat edge



OBWEGESER
18 cm/7"



VI-1132-06
6 mm



VI-1132-09
9 mm



VI-1132-07
7 mm



VI-1132-11
11 mm



BOIES
VI-1282-19
19.5 cm/8"

Ramus periosteal stripper



OBWEGESER
20.5 cm/8"

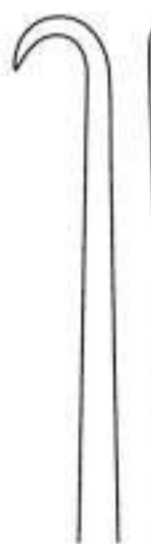

VI-1152-05
5 mm

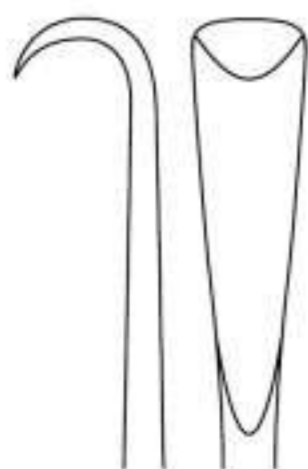

VI-1152-09
9 mm

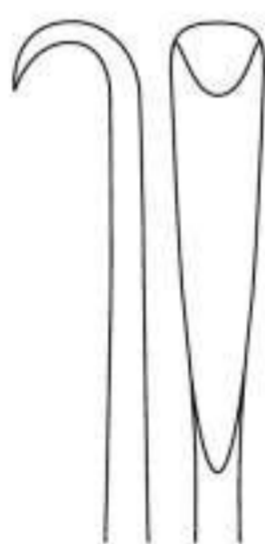

VI-1152-07
7 mm

Ramus periosteal stripper V-notched



OBWEGESER
17.5 cm/7"

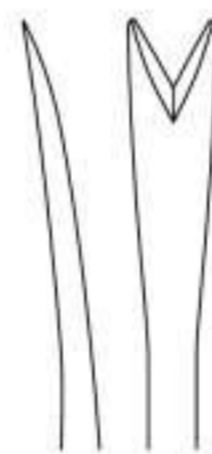

VI-1150-07
7 mm



VI-1150-09
9 mm

Mandibular stripper/inferior border raspatory



VI-1140-01
left

10 mm



VI-1140-02
right



OBWEGESER
18 cm/7"

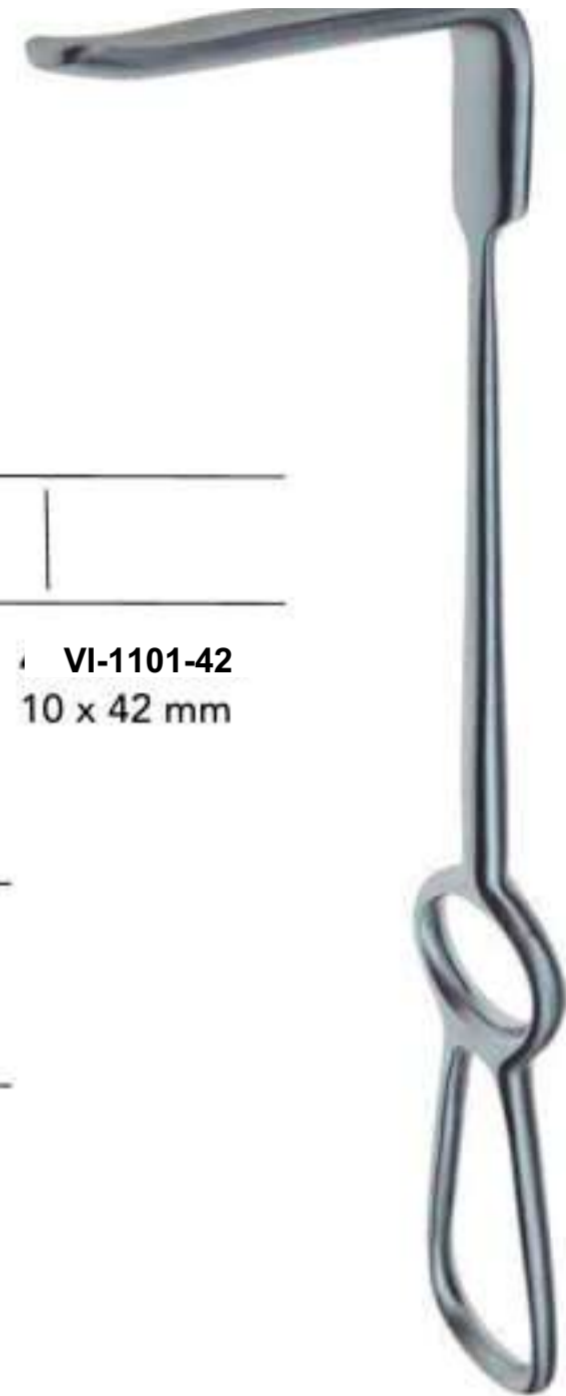
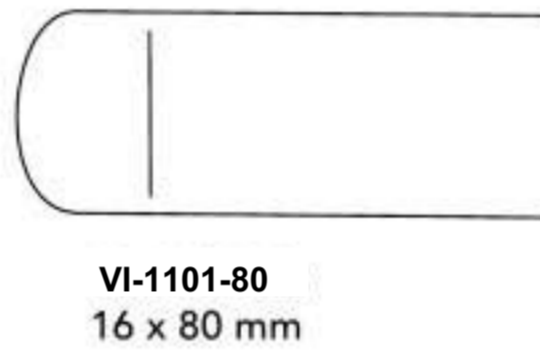
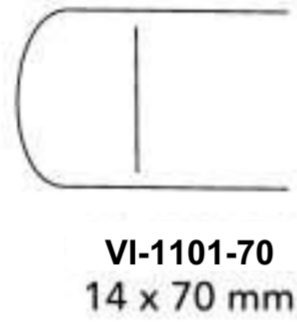
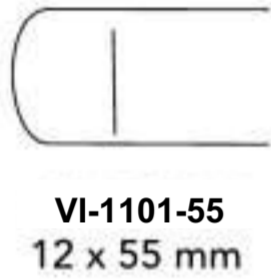
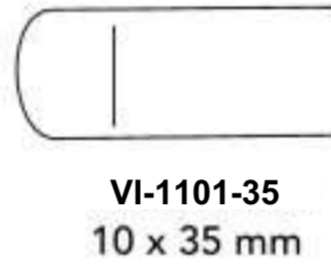
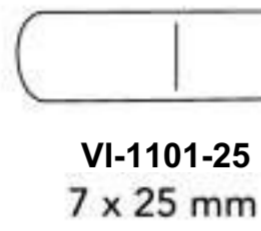
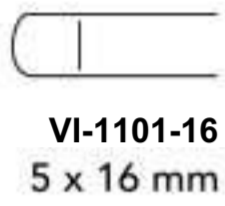
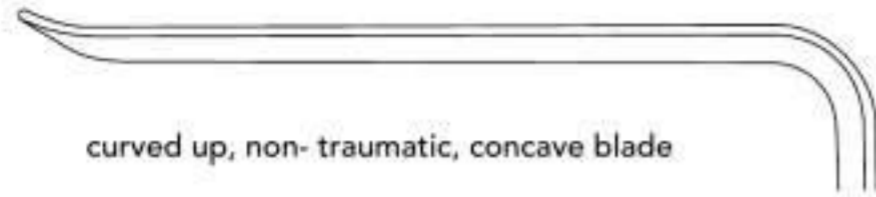

OBWEGESER
22 cm/8 3/4"

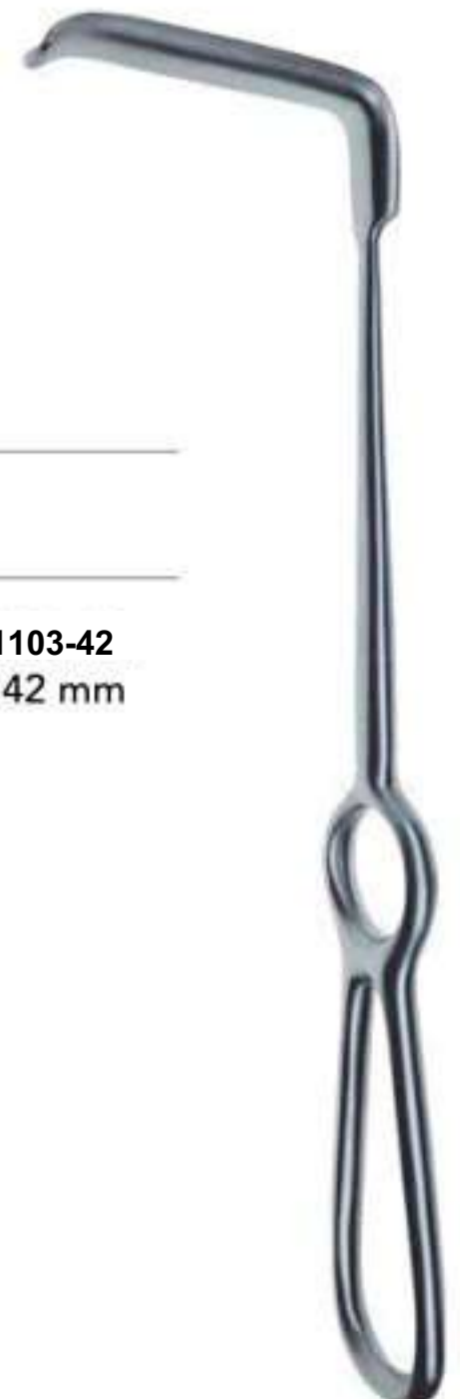
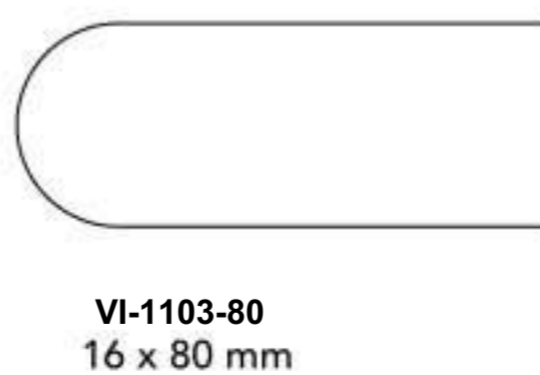
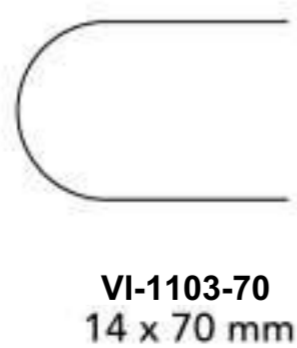
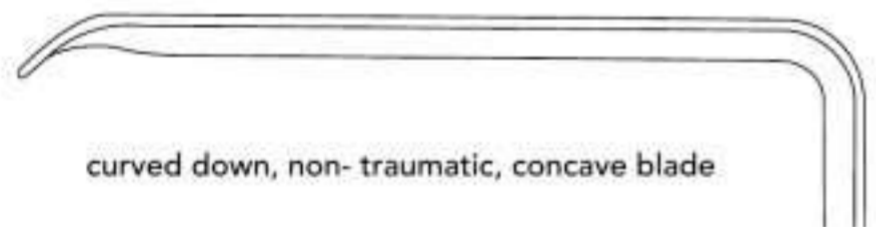

OBWEGESER
22 cm/8 3/4"

Mandibular channel retractors

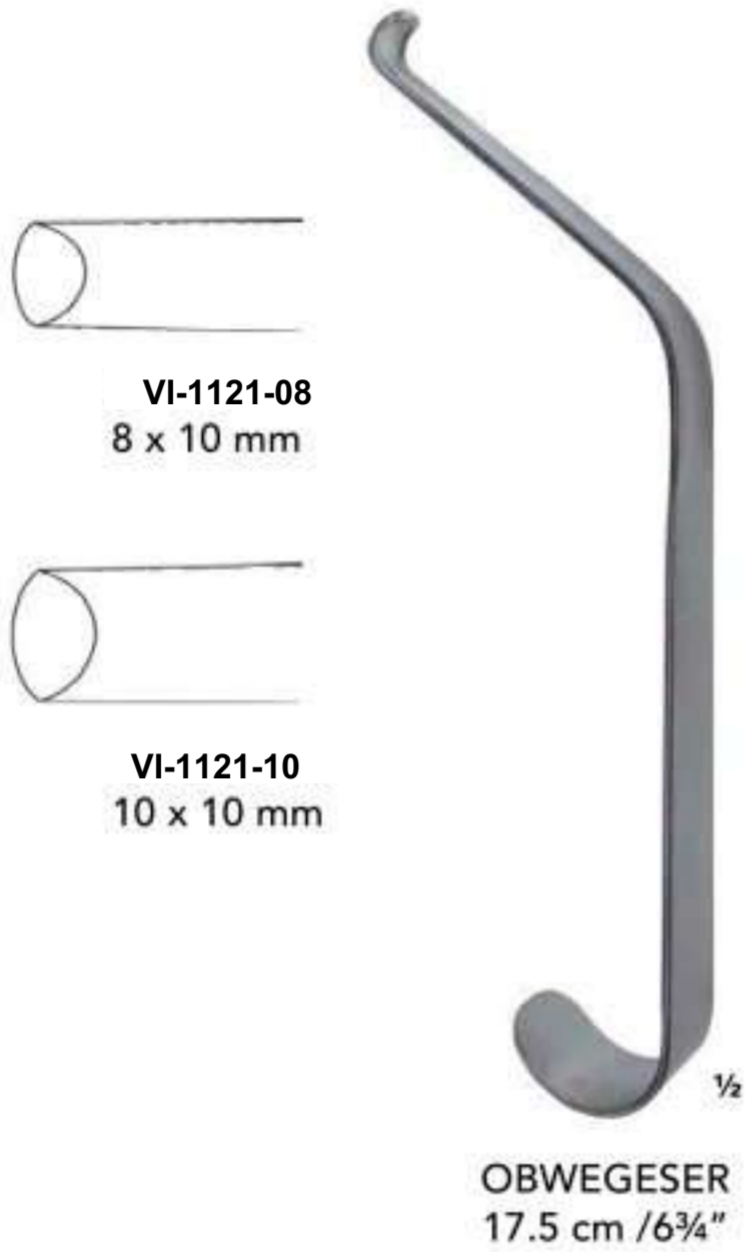

Mandibular retractors

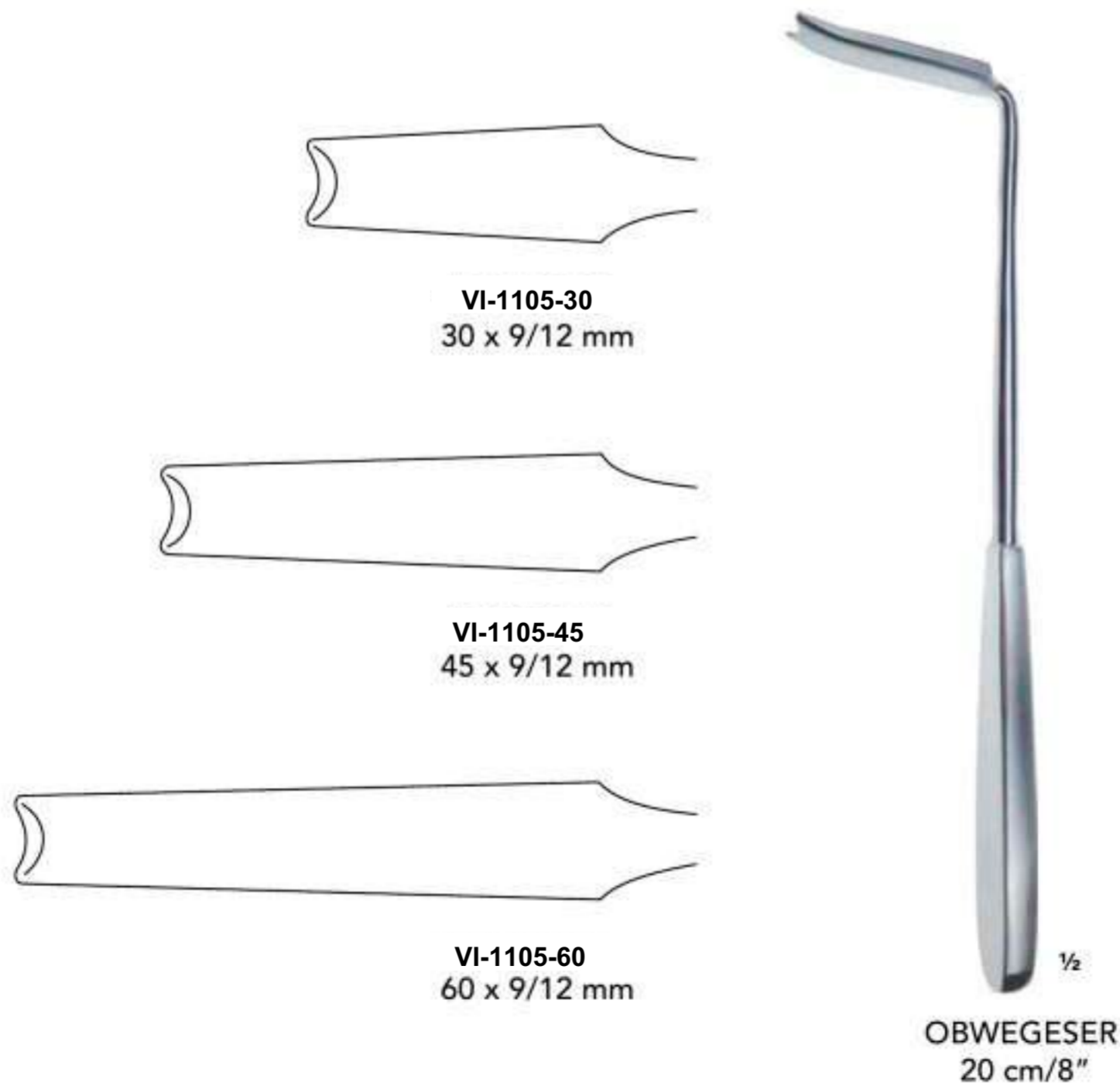

Ramus retractor

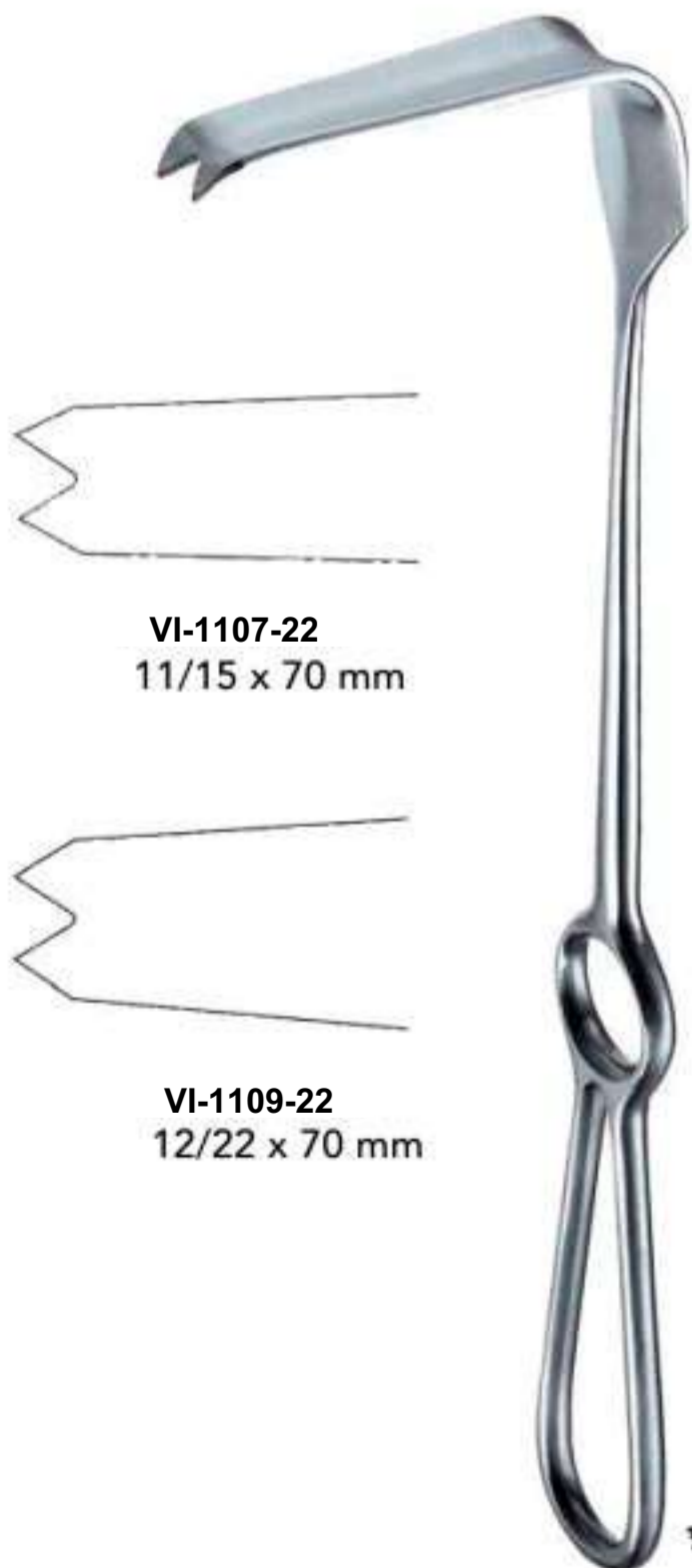

OBWEGESER
24.5 cm/9 $\frac{3}{4}$ "

Notched alveolar retractor

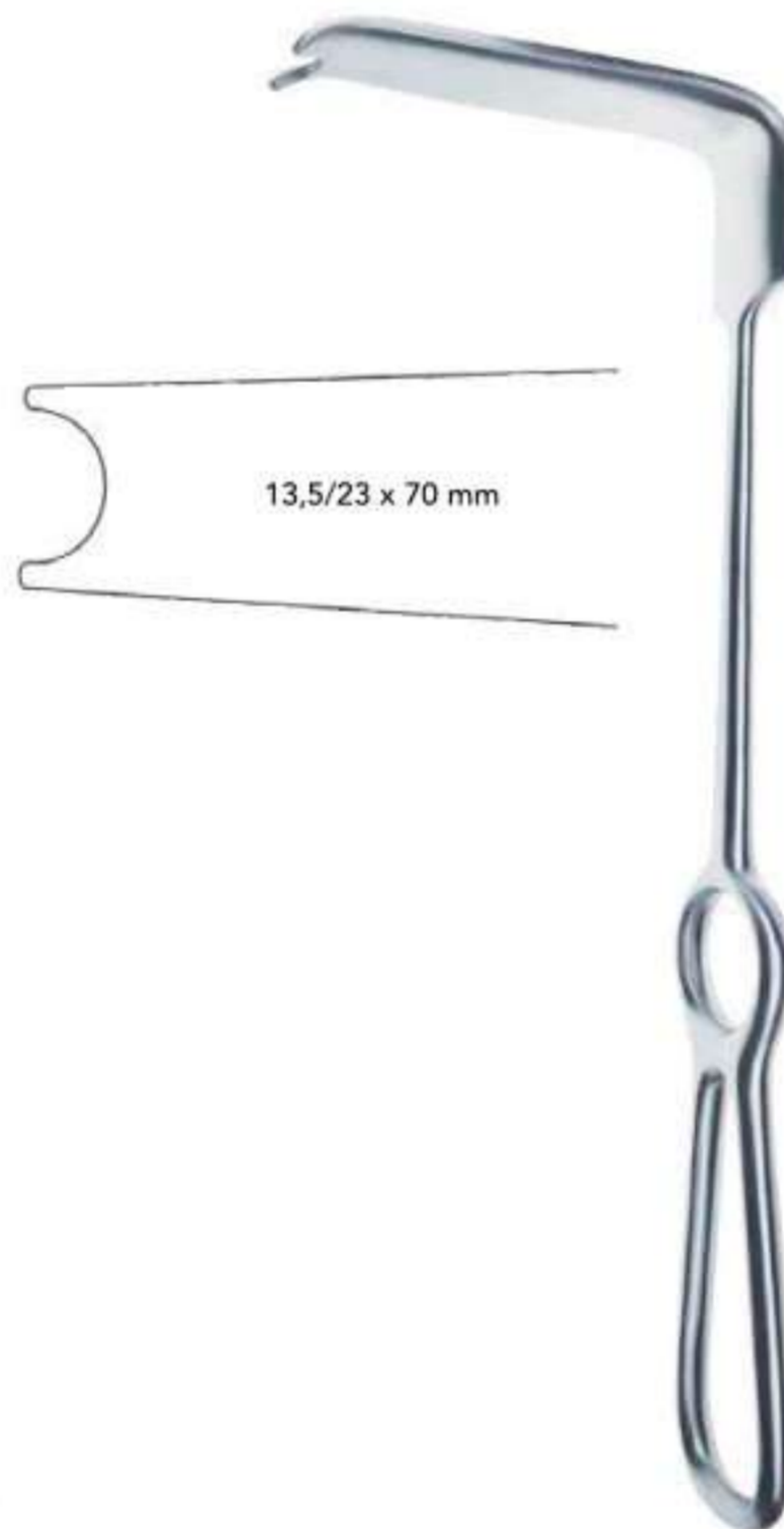

OBWEGESER
VI-1111-22
22 cm/9"

Nasal spine retractor

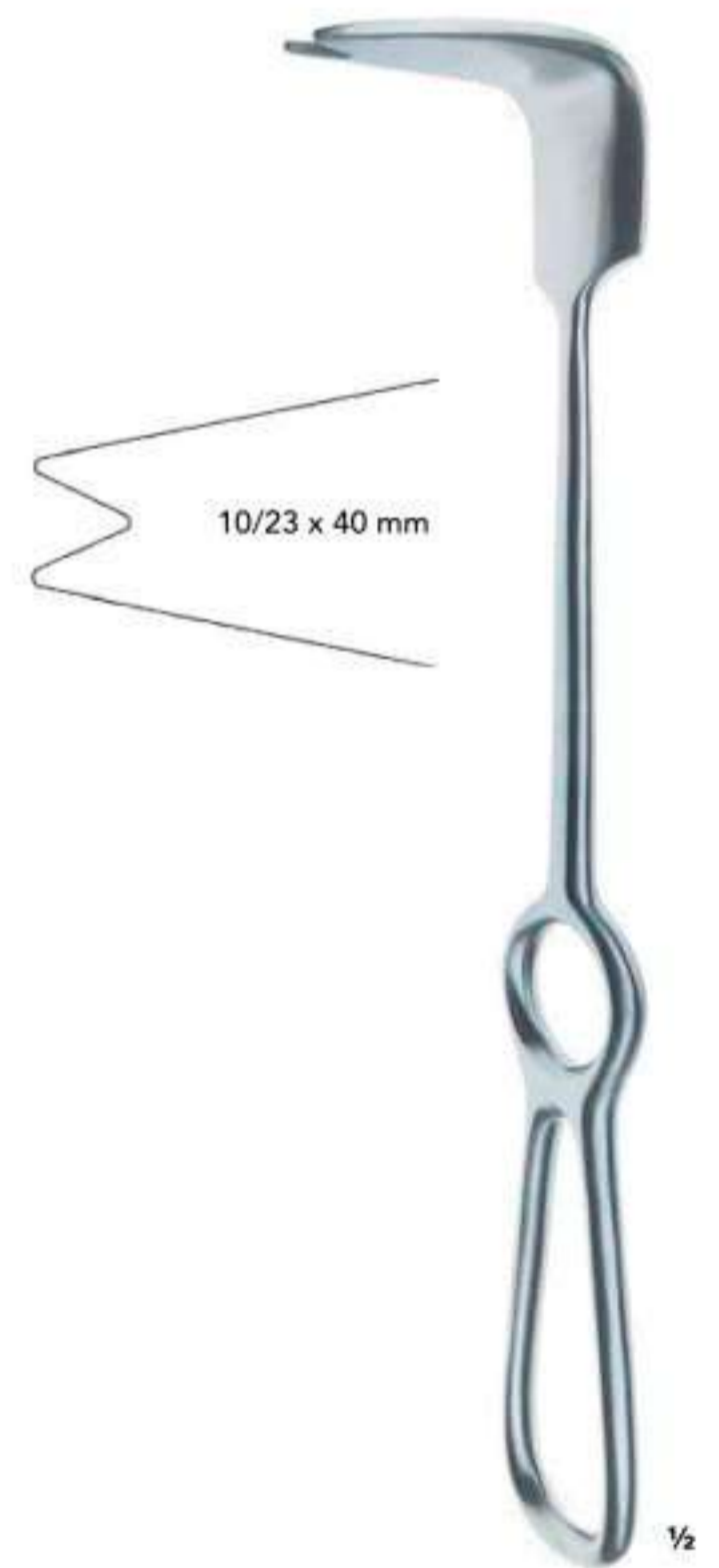

OBWEGESER
VI-1113-22
24.5 cm/9 $\frac{3}{4}$ "



Osteotomes for alveolar process

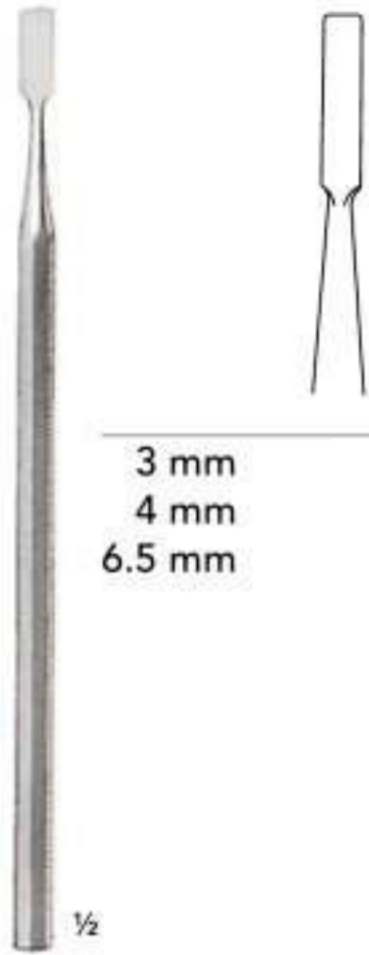

3 mm VI-1668-03
4 mm VI-1668-04
6.5 mm VI-1668-06

OBWEGESER
15.5 cm/6"

Osteotomes

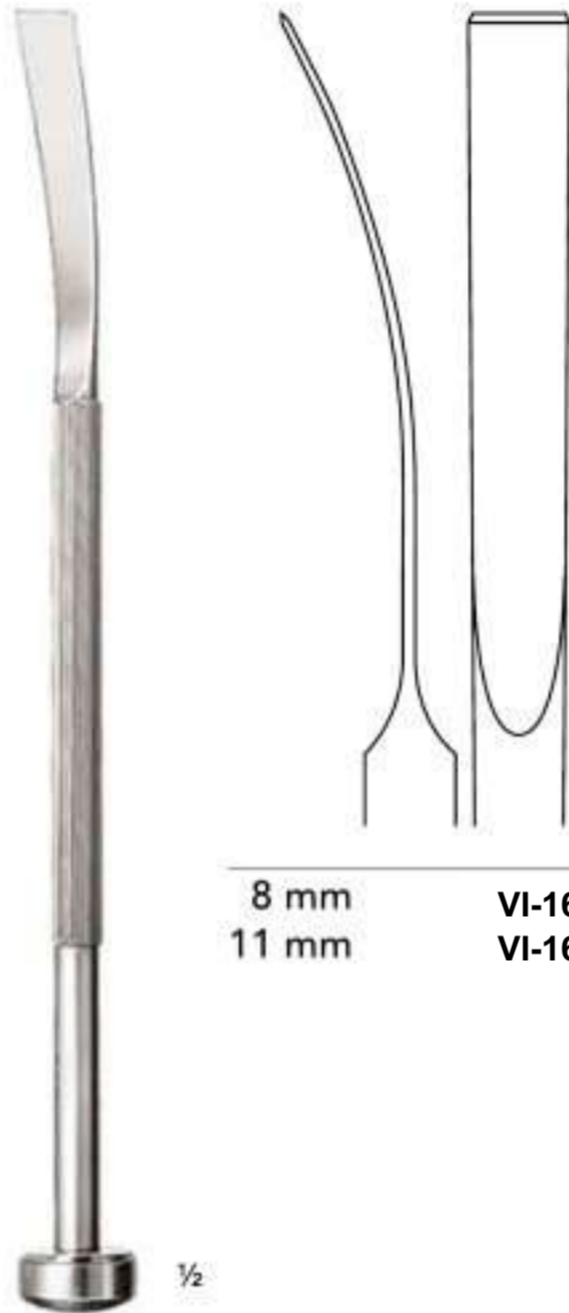

8 mm VI-1667-08
11 mm VI-1667-11

OBWEGESER
21 cm/8¼"

Maxillary mobilizer

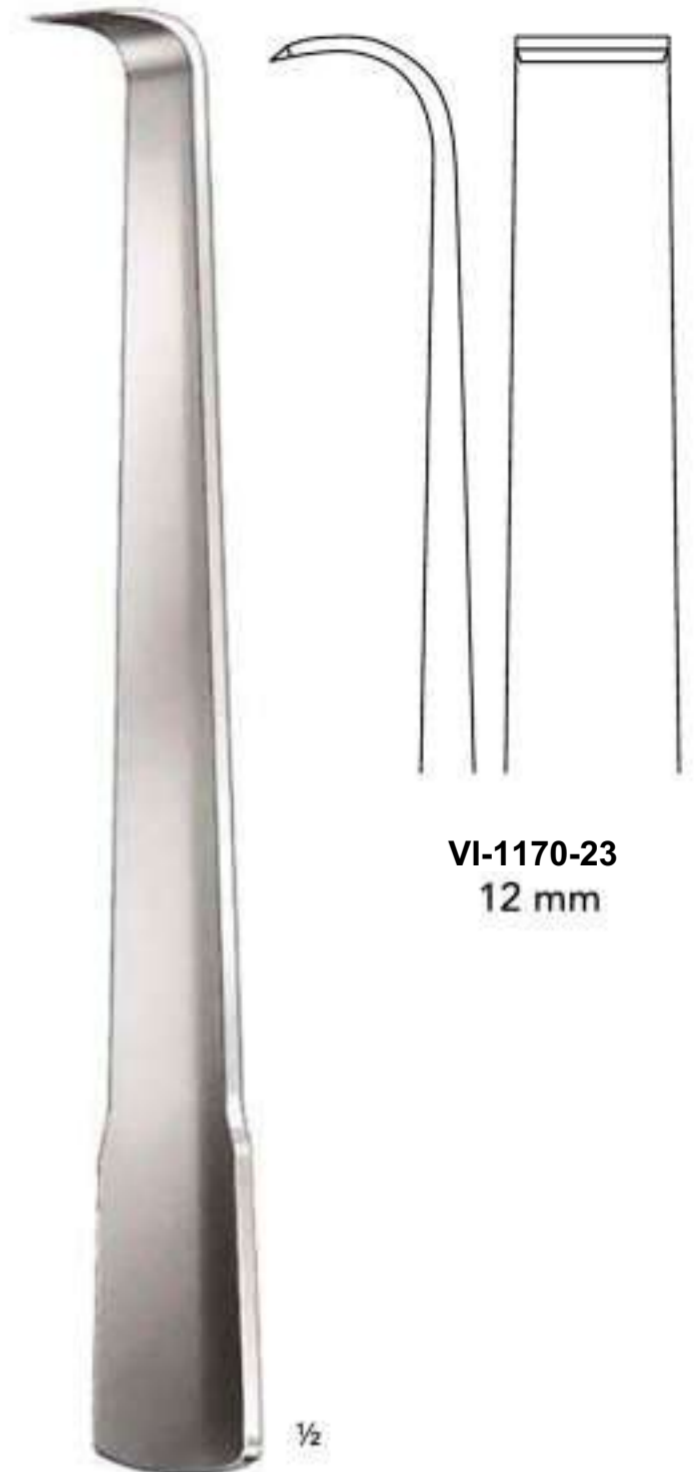

VI-1170-23
12 mm

OBWEGESER
23 cm/9"

convex / concave

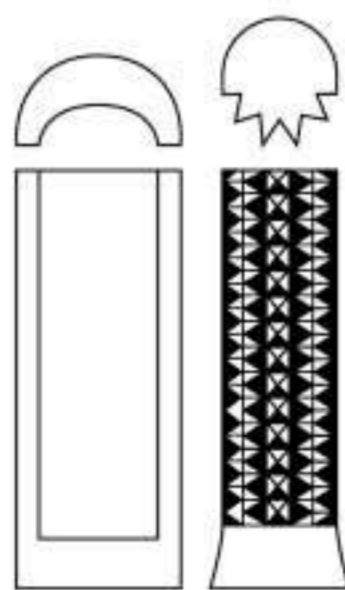

VI-1220-01
12 x 30 mm

Bone contouring forceps

½

concave / convex

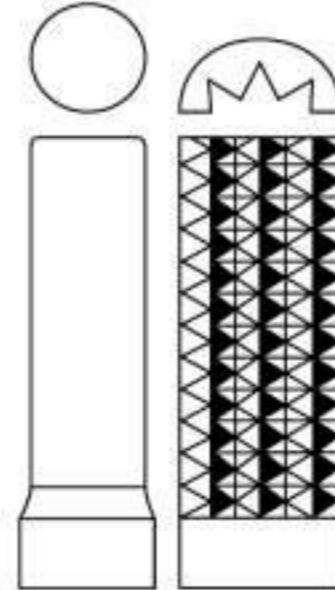

VI-1220-02
13.5 x 30 mm

Bone contouring forceps

½

flat / flat

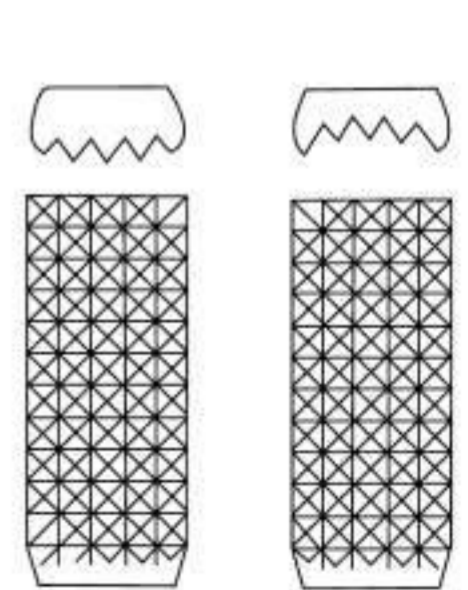

VI-1220-03
13.5 x 30 mm

OBWEGESER
17.5 cm/7"

OBWEGESER
17 cm/6¾"

OBWEGESER
17.5 cm/7"

Extra oral Signotch Retractors

9,5 mm x 16 mm

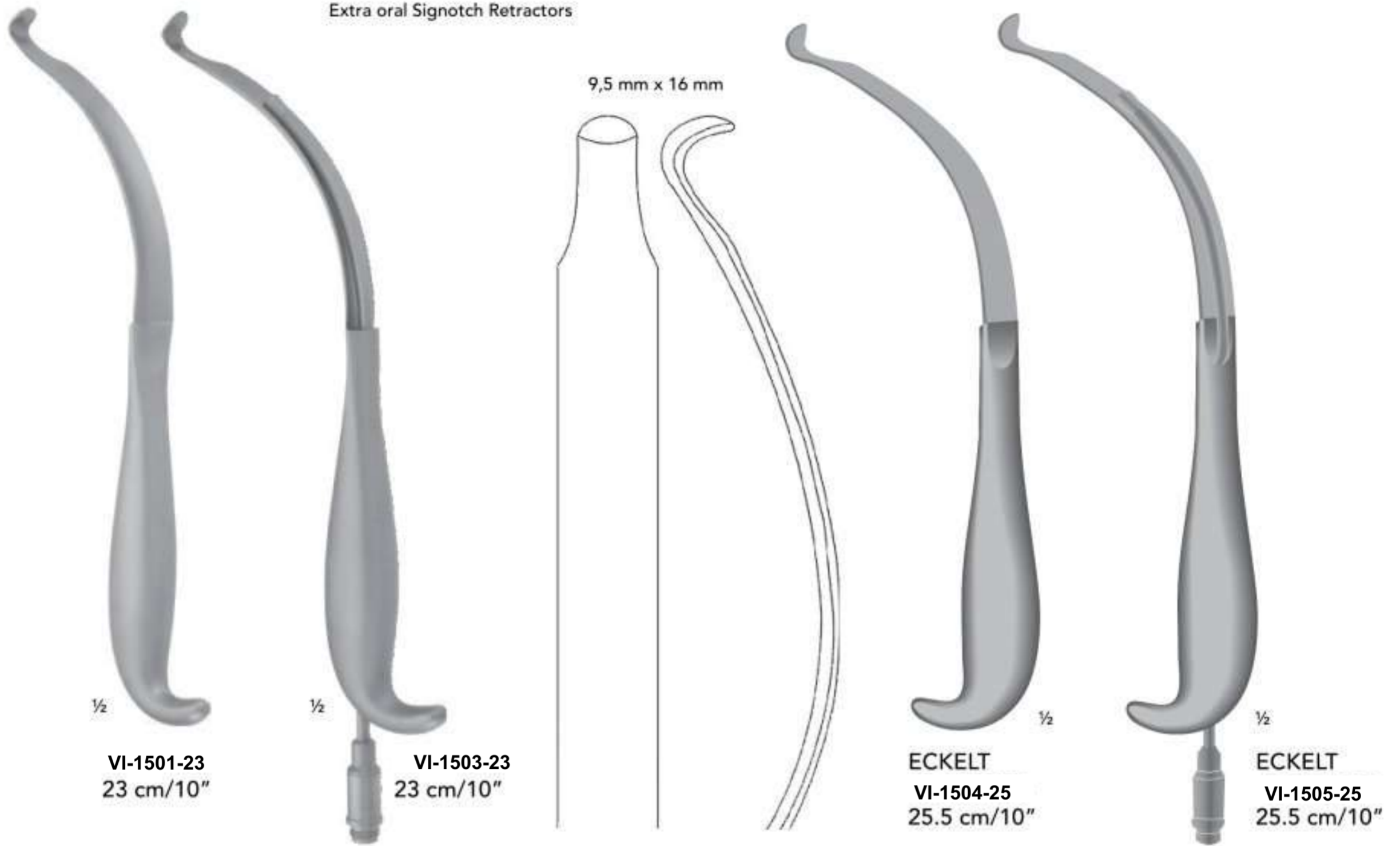

for right cheek

for left cheek

26,5 mm x 16 mm



for right cheek

for left cheek

BAUER

VI-1513-24
24.5 cm/9"

BAUER

VI-1515-24
24.5 cm/9"

25,5 mm

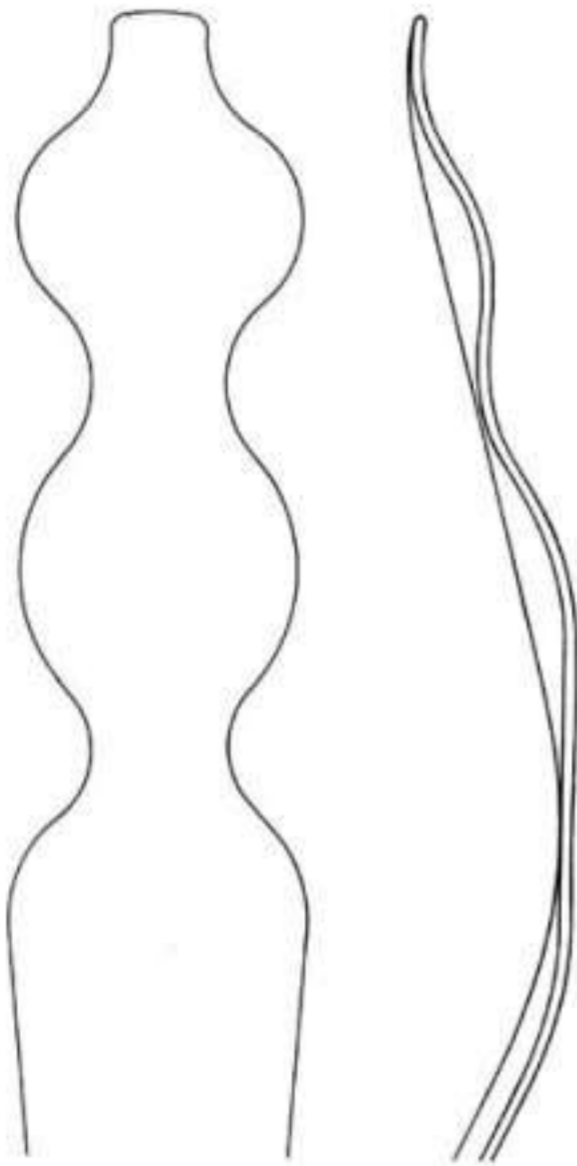

for LeFort osteotomies



1/2

PETRI-PTERYGOID
VI-1505-23
23 cm/9"



1/2

PETRI-PTERYGOID
VI-1507-23
23 cm/9"

12,5 mm / 27 mm

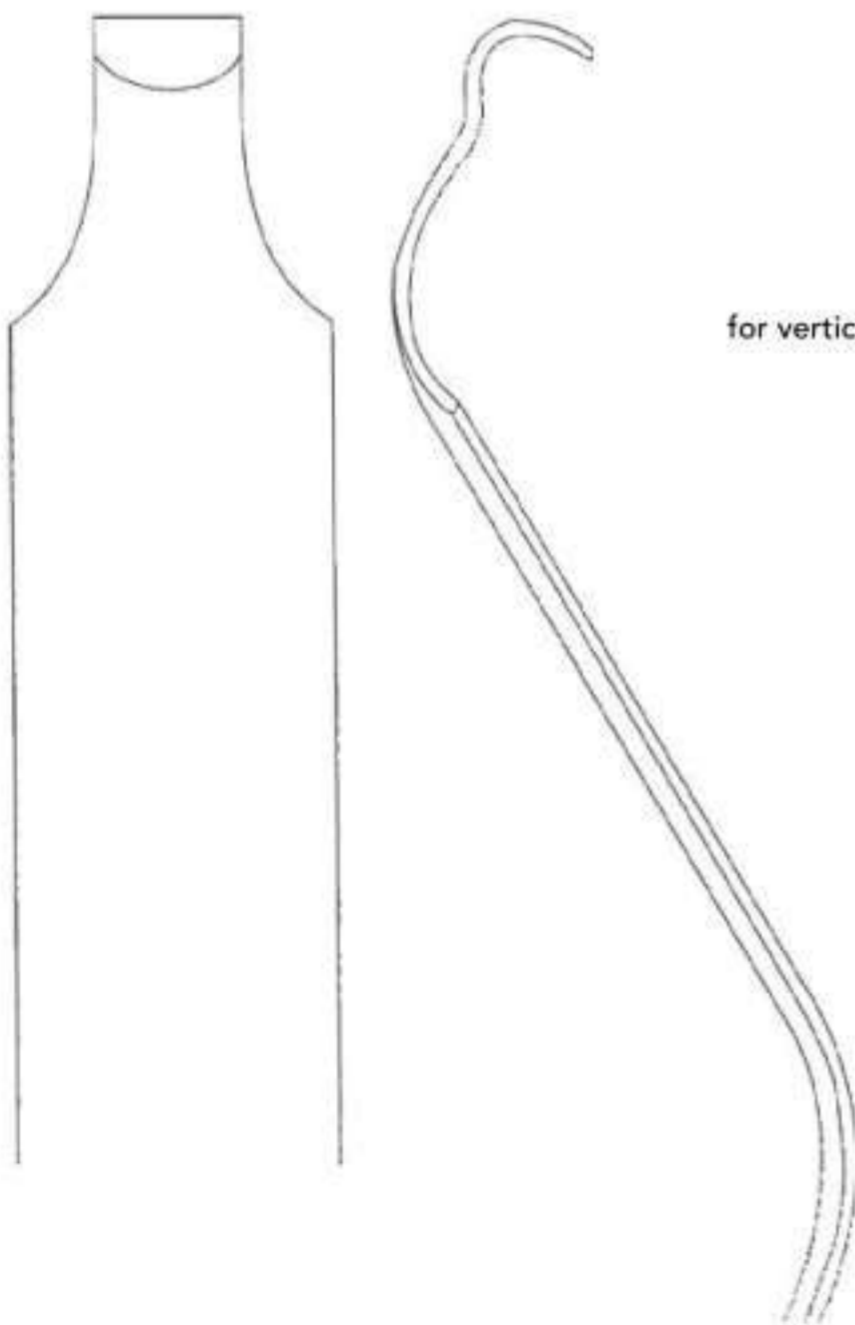

for vertical osteotomies



1/2

LEVASSEUR-MERRIL
VI-1517-25
25 cm/9 3/4"



1/2

LEVASSEUR-MERRIL
VI-1519-25
25 cm/9 3/4"

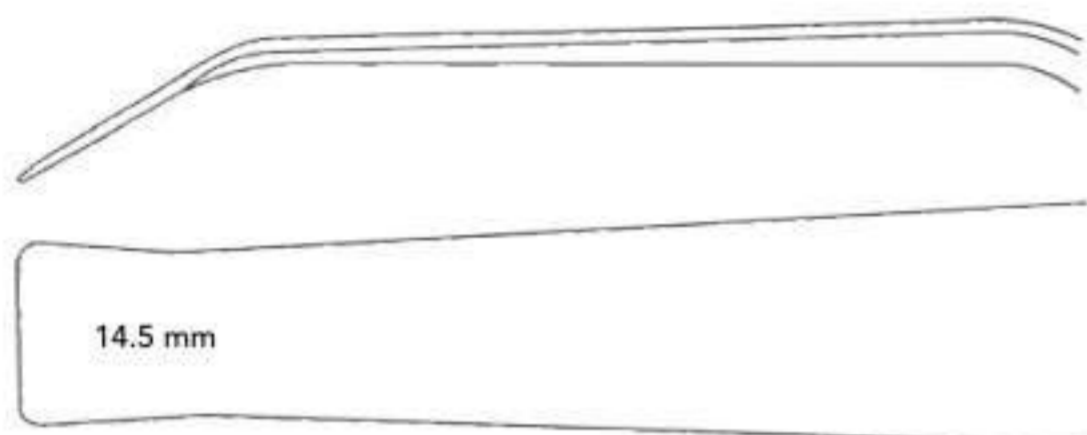

SHEA
VI-1523-22
22 cm/8¾"

SHEA
VI-1522-22
22 cm/8¾"

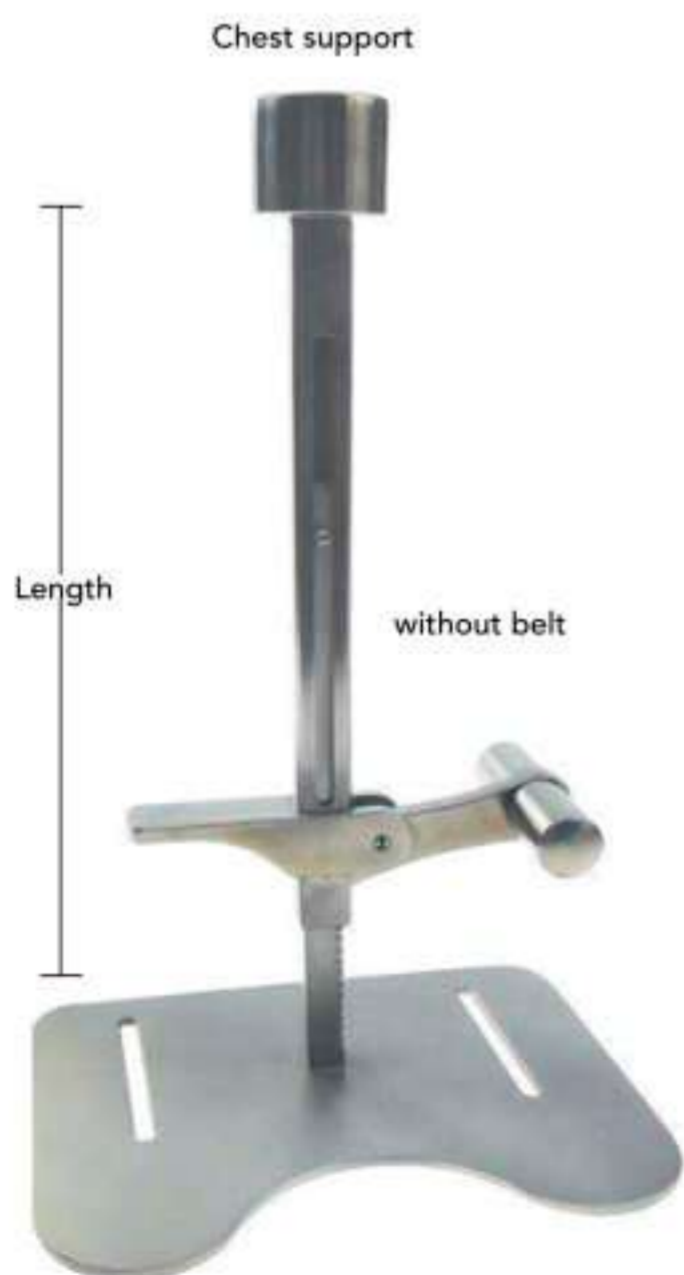

Length	NEGUS
85 mm	VI-4408-85
140 mm	VI-4408-40



VI-1199-15
15 cm/6"



VI-1197-21
21 cm/8 1/4"



VI-1198-26
26 cm/10 1/4"

Our Range of Best Selling Instruments

ENT INSTRUMENTS CATALOGUE



VASE **INSTRUMENTS**
PREMIUM QUALITY INSTRUMENTS

☎ +92-52-7046105

☎ +92-302-6132711

🌐 www.vaseinstruments.com

✉ vaseinstruments@gmail.com | info@vaseinstruments.com

📍 Defence Road, Al Hadi Town, Sialkot - 51310, Pakistan

